

# AOS503

AOS LiDAR

OBJECT DETECTION SYSTEMS

**SICK**  
Sensor Intelligence.



### Ordering information

Control configuration	Number of sensors	Max. range with 10 % reflectivity	Items supplied	Type	Part no.
Area monitoring and collision avoidance	3	40 m	LMS511-10100S02 (3 x) Flexi Soft main module FX3-CPU000000 Flexi Soft system plug FX3-MPL000001 Flexi Soft I/O module FX3-XTIO84002 (2 x) USB configuration cable USB stick with configuration files Ethernet connection cable LMS511 accessory set 1 (3 x)	AOS503	1066131

**Included in delivery:** FX3-MPL000001 (1), LMS511 accessories set 1 (3), YM2D24-100PN1MRJA4 (1), DSL-8U04G02M025KM1 (1), FX3-CPU000000 (1), FX3-XTIO84002 (2), LMS511-10100S02 (3)

Other models and accessories → [www.sick.com/AOS\\_LiDAR](http://www.sick.com/AOS_LiDAR)



### Detailed technical data

#### Features

<b>Sensor</b>	LMS511-10100S02
<b>Number of sensors</b>	3
<b>Aperture angle</b>	190°
<b>Max. range with 10 % reflectivity</b>	40 m
<b>Version</b>	Standard

#### Mechanics/electronics

<b>Housing dimensions (W x D x H)</b>	160 m x 155 m x 185 m (sensor) 67.5 m x 96.5 m x 120.6 m (control with three modules, 22.5 mm each)
<b>Weight</b>	3.7 kg, Per LMS, without connection box
<b>Supply voltage</b>	24 V DC <sup>1)</sup>
<b>Power consumption</b>	22 W, Per LMS511 (+ heating 55 W, per LMS) 6.9 W, Flexi Soft with 2 x I/O module (without load)
<b>Fixing</b>	Mounting kit (sensor), Mounting rail (control)

<sup>1)</sup> Per LMS.

<sup>2)</sup> Sensor.

<sup>3)</sup> Control.

<b>Enclosure rating</b>	IP65/ IP67 <sup>2)</sup> IP20 <sup>3)</sup>
-------------------------	--

<sup>1)</sup> Per LMS.

<sup>2)</sup> Sensor.

<sup>3)</sup> Control.

## Performance

<b>Number of laserscanners</b>	3
<b>Response time</b>	330 ms

## Interfaces

<b>Number of safety inputs</b>	✓ (16)
<b>Number of safe outputs</b>	✓ (8)
<b>Configuration interface</b>	Ethernet (sensor), USB (control)
<b>Output data</b>	Alarm via control signal Warning field intrusion, stop field intrusion System test error Contamination warning

## Ambient data

<b>Ambient operating temperature</b>	-30 °C ... +50 °C, Sensor -25 °C ... +55 °C, Control
<b>Ambient temperature, storage</b>	-30 °C ... +70 °C <sup>1)</sup> -25 °C ... +70 °C <sup>2)</sup>
<b>Ambient light immunity</b>	70,000 lx
<b>Vibration resistance</b>	
Standard	IEC 60068-2-6:2007-12
<b>Shock resistance</b>	IEC 60068-2-27:2008-03

<sup>1)</sup> Sensor.

<sup>2)</sup> Control.

## General notes

<b>Items supplied</b>	LMS511-10100S02 (3 x) Flexi Soft main module FX3-CPU000000 Flexi Soft system plug FX3-MPL000001 Flexi Soft I/O module FX3-XTIO84002 (2 x) USB configuration cable USB stick with configuration files Ethernet connection cable LMS511 accessory set 1 (3 x)
<b>Note on use</b>	The AOS LiDAR object detection system is not a safety device for human protection and it therefore does not comply with any safety standards. For safety applications, please contact SICK AG.

## Classifications

<b>ECLASS 5.0</b>	27281001
<b>ECLASS 5.1.4</b>	27280190
<b>ECLASS 6.0</b>	27280190
<b>ECLASS 6.2</b>	27280190
<b>ECLASS 7.0</b>	27280190
<b>ECLASS 8.0</b>	27280190

<b>ECLASS 8.1</b>	27280190
<b>ECLASS 9.0</b>	27280190
<b>ECLASS 10.0</b>	27280190
<b>ECLASS 11.0</b>	27280190
<b>ECLASS 12.0</b>	27280190
<b>UNSPSC 16.0901</b>	43211701

**Dimensional drawing** (Dimensions in mm (inch))

LMS511

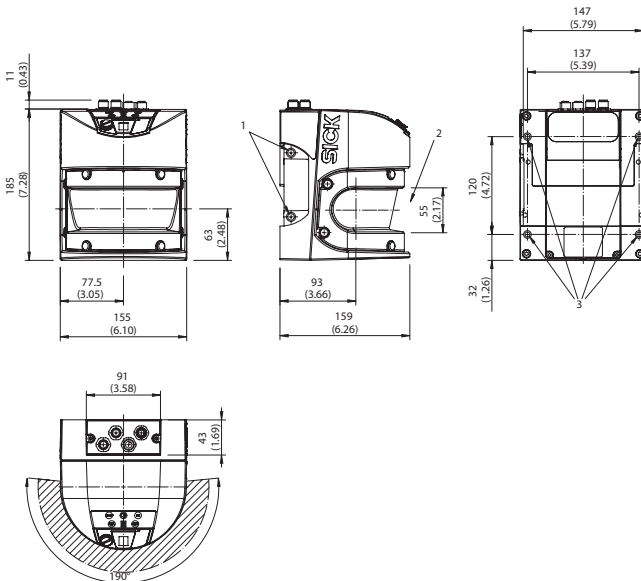

- ① 4 screw holes M8 x 9
- ② Do not block front screen
- ③ 4 screw holes M6 x 8

FX3-XTIO, FX3-XTDI

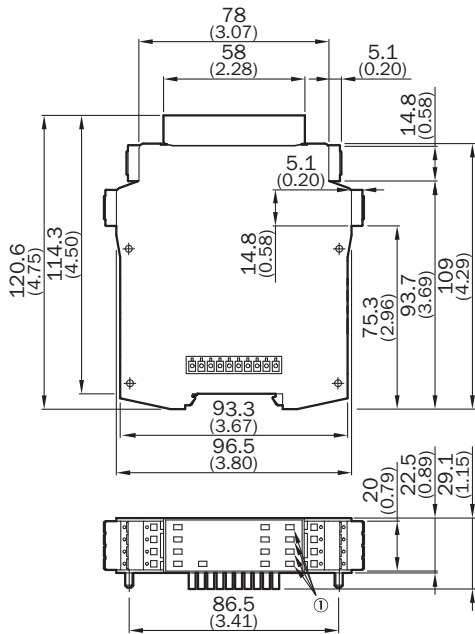

① Only valid for FX3-XTIO



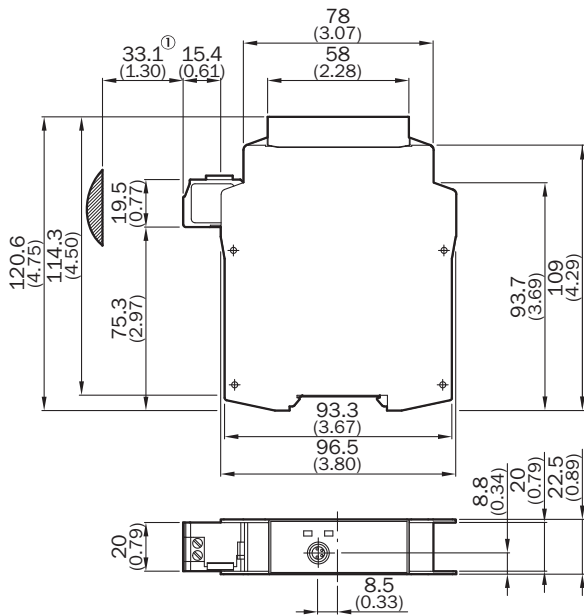

FX3-CPU0



① Approximate connector range

Recommended accessories

Other models and accessories → [www.sick.com/AOS\\_LiDAR](http://www.sick.com/AOS_LiDAR)

	Brief description	Type	Part no.
<b>Test and monitoring tools</b>			
	Alignment aid for detecting the infrared light (wavelength 780 nm to 1050 nm) of SICK sensors	Alignment aid	2101720
<b>Device protection (mechanical)</b>			
	Weather hood (125°), aluminum powder-coated, Aluminum (powder-coating)	Weather hood 125° for LMS5xx	2026151
<b>Terminal and alignment brackets</b>			
	Mounting kit for fine adjustment: For LMS1000/MRS1000, always use "Mounting kit 1a 2093194" or "Mounting kit 1b 2085935" and "Adapter plate 2085937", Stainless steel V2A (1.4301)	Fine adjustment bracket	2076764
	Mounting kit for mast mount. When mounting with tightening straps, suitable for mast diameter of 95 mm or greater, Stainless steel V2A (1.4301)	Mounting kit	1081412

## SICK AT A GLANCE

SICK is one of the leading manufacturers of intelligent sensors and sensor solutions for industrial applications. A unique range of products and services creates the perfect basis for controlling processes securely and efficiently, protecting individuals from accidents and preventing damage to the environment.

We have extensive experience in a wide range of industries and understand their processes and requirements. With intelligent sensors, we can deliver exactly what our customers need. In application centers in Europe, Asia and North America, system solutions are tested and optimized in accordance with customer specifications. All this makes us a reliable supplier and development partner.

Comprehensive services complete our offering: SICK LifeTime Services provide support throughout the machine life cycle and ensure safety and productivity.

For us, that is “Sensor Intelligence.”

## WORLDWIDE PRESENCE:

Contacts and other locations –[www.sick.com](http://www.sick.com)