



ARS60-F1K00512

ARS60

ABSOLUTE ENCODERS

SICK
Sensor Intelligence.



Illustration may differ



Ordering information

Type	Part no.
ARS60-F1K00512	1032833

Other models and accessories → www.sick.com/ARS60

Detailed technical data

Performance

Number of steps per revolution (max. resolution)	512 (9 bit)
Measuring step	360° / number of steps
Measuring step deviation	0.005° binary number of steps
Error limits G	0.035° (binary number of steps) ¹⁾
Repeatability standard deviation σ_r	0.005° ²⁾

¹⁾ In accordance with DIN ISO 1319-1, position of the upper and lower error limit depends on the installation situation, specified value refers to a symmetrical position, i.e. deviation in upper and lower direction is the same.

²⁾ In accordance with DIN ISO 55350-13; 68.3% of the measured values are inside the specified area.

Interfaces

Communication interface	Parallel data world
Initialization time	80 ms ¹⁾
Code type	Gray
Code sequence parameter adjustable	CW (clockwise) increasing when viewing the clockwise rotating shaft
Measured value backlash	0.005°
Response threshold	0.003°

¹⁾ Valid positional data can be read once this time has elapsed.

Electrical data

Connection type	Cable, 22-wire, radial, 1.5 m
Supply voltage	10 ... 32 V
Operating current	Typ. 90 mA
MTTFd: mean time to dangerous failure	300 years (EN ISO 13849-1) ¹⁾
Switching level of control inputs	Logic H = 0.7 x U _S , Logic L = 0 V ... 0.3 x U _S
Actuation of set button	≥ 100 ms ²⁾

¹⁾ This product is a standard product and does not constitute a safety component as defined in the Machinery Directive. Calculation based on nominal load of components, average ambient temperature 40°C, frequency of use 8760 h/a. All electronic failures are considered hazardous. For more information, see document no. 8015532.

²⁾ Only with shaft stationary (note initialisation time).

Mechanical data

Mechanical design	Solid shaft, Servo flange
Shaft diameter	6 mm
Shaft length	10 mm
Weight	Approx. 0.3 kg ¹⁾
Housing material	Aluminum die cast
Start up torque	Typ. 0.25 Ncm
Operating torque	Typ. 0.2 Ncm
Permissible shaft loading	20 N (radial) 10 N (axial)
Operating speed	≤ 6,000 min ⁻¹ with shaft seal ≤ 10,000 min ⁻¹ without shaft seal ²⁾
Moment of inertia of the rotor	48 gcm ²
Bearing lifetime	3.6 x 10 ⁹ revolutions
Angular acceleration	≤ 500,000 rad/s ²

¹⁾ Based on devices with male connector.

²⁾ If the shaft seal has been removed by the customer.

Ambient data

EMC	According to EN 61000-6-2 and EN 61000-6-3 ¹⁾
Enclosure rating	IP66, cable (IEC 60529)
Permissible relative humidity	90 % (Condensation not permitted)
Operating temperature range	-20 °C ... +85 °C
Storage temperature range	-40 °C ... +100 °C, without package
Resistance to shocks	50 g, 11 ms (EN 60068-2-27)
Resistance to vibration	20 g, 10 Hz ... 2,000 Hz (EN 60068-2-6)

¹⁾ EMC according to the standards quoted is achieved if shielded cables are used.

Classifications

ECLASS 5.0	27270502
ECLASS 5.1.4	27270502
ECLASS 6.0	27270590
ECLASS 6.2	27270590
ECLASS 7.0	27270502
ECLASS 8.0	27270502
ECLASS 8.1	27270502
ECLASS 9.0	27270502
ECLASS 10.0	27270502
ECLASS 11.0	27270502
ECLASS 12.0	27270502
ETIM 5.0	EC001486
ETIM 6.0	EC001486
ETIM 7.0	EC001486

ETIM 8.0	EC001486
UNSPSC 16.0901	41112113

Dimensional drawing (Dimensions in mm (inch))

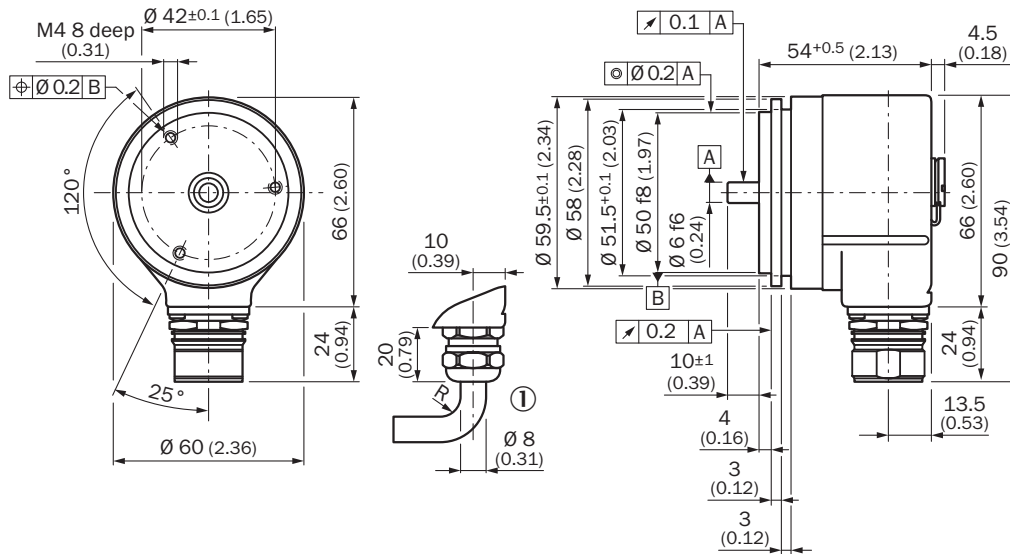

General tolerances according to DIN ISO 2768-mk
 ① R = min. bending radius 40 mm

PIN assignment

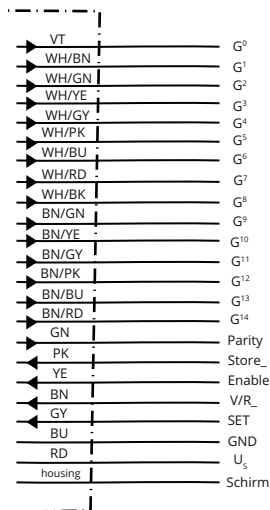

PIN	Wire colors (cable connection)	Signal Binary	Signal Gray	Signal BCD
1	Violet	2 ⁰	G ⁰	2 ⁰ v. 10 ⁰
2	White/brown	2 ¹	G ¹	2 ¹ v. 10 ⁰
3	White/green	2 ²	G ²	2 ² v. 10 ⁰





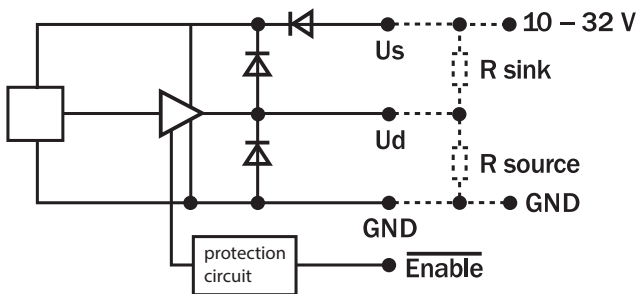

PIN	Wire colors (cable connection)	Signal Binary	Signal Gray	Signal BCD
4	White/yellow	2^3	G ³	$2^3 \text{ v. } 10^0$
5	White/grey	2^4	G ⁴	$2^0 \text{ v. } 10^1$
6	White/pink	2^5	G ⁵	$2^1 \text{ v. } 10^1$
7	White/blue	2^6	G ⁶	$2^2 \text{ v. } 10^1$
8	White/red	2^7	G ⁷	$2^3 \text{ v. } 10^1$
9	White/black	2^8	G ⁸	$2^0 \text{ v. } 10^2$
10	Brown/green	2^9	G ⁹	$2^1 \text{ v. } 10^2$
11	Brown/yellow	2^{10}	G ¹⁰	$2^2 \text{ v. } 10^2$
12	Brown/gray	2^{11}	G ¹¹	$2^3 \text{ v. } 10^2$
13	Brown/pink	2^{12}	G ¹²	$2^0 \text{ v. } 10^3$
14	Brown/blue	2^{13}	G ¹³	$2^1 \text{ v. } 10^3$
15	Brown/red	2^{14}	G ¹⁴	$2^2 \text{ v. } 10^3$
16	Green	Parity	Parity	
17	Pink	Store		
18	Yellow	Enable		
19	Brown	CW/CCW (V/R)		
*	Gray	SET		
20	Blue	GND		
21	Red	U _S		

Diagrams



Recommended accessories

Other models and accessories → www.sick.com/ARS60

	Brief description	Type	Part no.
Other mounting accessories			
	Mounting bell for encoder with servo flange, 50 mm spigot, mounting kit included	BEF-MG-50	5312987
	Half-shell servo clamps (2 pcs.) for servo flanges with a 50 mm centering hub	BEF-WG-SF050	2029165
	Servo clamps, large, for servo flange (clamps, eccentric fastener), 3 pcs, without mounting material, without mounting hardware	BEF-WK-SF	2029166
Shaft adaptation			
	Bellows coupling, shaft diameter 6 mm / 6 mm, maximum shaft offset: radial ± 0.25 mm, axial ± 0.4 mm, angular +/- 4°; max. speed 10,000 rpm, -30 °C to +120 °C, max. torque 120 Ncm; material: stainless steel bellows, aluminum hub	KUP-0606-B	5312981
	Bellows coupling, shaft diameter 6 mm / 10 mm, maximum shaft offset: radial ± 0.25 mm, axial ± 0.4 mm, angular +/- 4°; max. speed 10,000 rpm, -30 °C to +120 °C, max. torque 120 Ncm; material: stainless steel bellows, aluminum hub	KUP-0610-B	5312982
	Spring washer coupling, shaft diameter 6 mm / 10 mm, Maximum shaft offset: radial +/- 0.3 mm, axial +/- 0.4 mm, angular +/- 2.5°; max. speed 12,000 rpm, -10° to +80 °C, max. torque 60 Ncm; material: aluminum flange, glass fiber-reinforced polyamide membrane and hardened steel coupling pin	KUP-0610-F	5312985
Others			
	<ul style="list-style-type: none"> • Connection type head A: Flying leads • Connection type head B: Flying leads • Signal type: Parallel • Items supplied: By the meter • Cable: 22-wire, PUR, halogen-free • Description: Parallel, shielded 	LTG-2622-MW	6027532

SICK AT A GLANCE

SICK is one of the leading manufacturers of intelligent sensors and sensor solutions for industrial applications. A unique range of products and services creates the perfect basis for controlling processes securely and efficiently, protecting individuals from accidents and preventing damage to the environment.

We have extensive experience in a wide range of industries and understand their processes and requirements. With intelligent sensors, we can deliver exactly what our customers need. In application centers in Europe, Asia and North America, system solutions are tested and optimized in accordance with customer specifications. All this makes us a reliable supplier and development partner.

Comprehensive services complete our offering: SICK LifeTime Services provide support throughout the machine life cycle and ensure safety and productivity.

For us, that is “Sensor Intelligence.”

WORLDWIDE PRESENCE:

Contacts and other locations –www.sick.com