



# AS30-EBM314I220A00

AS30

ARRAY SENSORS

**SICK**  
Sensor Intelligence.



Illustration may differ



### Ordering information

Type	Part no.
AS30-EBM314I220A00	1095577

**Included in delivery:** REF-AX-002 (1)

Other models and accessories → [www.sick.com/AS30](http://www.sick.com/AS30)

### Detailed technical data

#### Features

<b>Sensor principle</b>	Proximity system, Reflector mode
<b>Functional principle</b>	Web guiding, positioning
<b>Principle of operation (default)</b>	Web guiding
<b>Dimensions (W x H x D)</b>	31 mm x 62 mm x 52.2 mm
<b>Sensing distance</b>	≤ 25 mm
<b>Housing design</b>	Rectangular
<b>Working range</b>	20 mm ... 30 mm
<b>Measurement range</b>	30 mm
<b>Minimum detectable object (MDO)</b>	0.2 mm
<b>Light source</b>	LED, White
<b>Wave length</b>	400 nm ... 700 nm
<b>Light spot size</b>	38.9 mm x 11.1 mm
<b>Repeatability</b>	0.03 mm <sup>1)</sup>
<b>Linearity (position value)</b>	± 2 %
<b>Resolution</b>	1 µm
<b>Adjustment</b>	IO-Link, Display
<b>Teach-in mode</b>	Edge detection Area detection

<sup>1)</sup> With respect to sensing distance.

## Mechanics/electronics

<b>Supply voltage</b>	18 V ... 30 V
<b>Ripple</b>	$\leq 5 \text{ V}^{1)}$
<b>Current consumption</b>	$< 3.1 \text{ W}^{2)}$
<b>Switching frequency</b>	500 Hz
<b>Switching output</b>	Push-pull: PNP/NPN
<b>Switching output (voltage)</b>	Push-pull: PNP/NPN HIGH = $U_V - 3 \text{ V}$ /LOW $\leq 3 \text{ V}$
<b>Analog output</b>	4 mA ... 20 mA
<b>Resolution of analog output</b>	12 bit
<b>Output rate of analog output</b>	1 ms
<b>Output current <math>I_{\text{max}}</math></b>	$< 100 \text{ mA}$
<b>Initialization time</b>	0.48 s
<b>Connection type</b>	Male connector M12, 5-pin
<b>Protection class</b>	III <sup>3)</sup>
<b>Circuit protection</b>	$U_V$ connections, reverse polarity protected Output Q short-circuit protected Interference pulse suppression
<b>Enclosure rating</b>	IP67
<b>Weight</b>	250 g
<b>Housing material</b>	Zinc diecast
<b>Optics material</b>	Anti-reflex coating

<sup>1)</sup> May not fall below or exceed  $U_V$  tolerances.

<sup>2)</sup> Without load.

<sup>3)</sup>  $I_N = 2 \text{ A}$ .

## Communication interface

<b>IO-Link</b>	✓
VendorID	26
DeviceID HEX	0x80020B
DeviceID DEC	8389131
<b>Cycle time</b>	$> 1.1 \text{ ms}$

## Ambient data

<b>Ambient operating temperature</b>	$-10 \text{ °C} \dots +55 \text{ °C}$
<b>Ambient temperature, storage</b>	$-25 \text{ °C} \dots +75 \text{ °C}$
<b>Shock load</b>	According to IEC 60068
<b>UL File No.</b>	NRKH.E181493 & NRKH7.E181493

## Smart Task

<b>Smart Task name</b>	Base logics
<b>Logic function</b>	Direct AND OR Window
<b>Switching signal</b>	
Switching signal $Q_{L1}$	Switching output

Switching signal Q <sub>L2</sub>	Switching output
<b>Classifications</b>	
<b>ECLASS 5.0</b>	27270906
<b>ECLASS 5.1.4</b>	27270906
<b>ECLASS 6.0</b>	27270906
<b>ECLASS 6.2</b>	27270906
<b>ECLASS 7.0</b>	27270906
<b>ECLASS 8.0</b>	27270906
<b>ECLASS 8.1</b>	27270906
<b>ECLASS 9.0</b>	27270906
<b>ECLASS 10.0</b>	27270906
<b>ECLASS 11.0</b>	27270906
<b>ECLASS 12.0</b>	27270906
<b>ETIM 5.0</b>	EC001820
<b>ETIM 6.0</b>	EC001820
<b>ETIM 7.0</b>	EC001820
<b>ETIM 8.0</b>	EC001820
<b>UNSPSC 16.0901</b>	39121528

Dimensional drawing (Dimensions in mm (inch))

AS30-xxx31xxxxxxxx

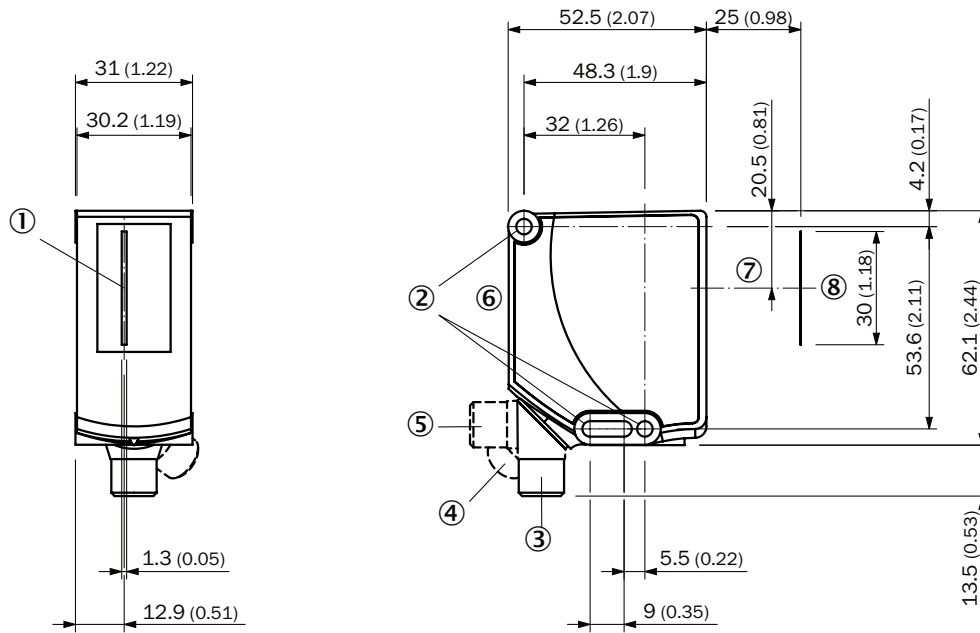

- ① Center field of view
- ② Fixing hole
- ③ M12 male connector, delivery state
- ④ M12 male connector, end stop right
- ⑤ M12 male connector, end stop left
- ⑥ Display and adjustment elements
- ⑦ Optical axis
- ⑧ Field of view

Adjustments

Display and adjustment elements

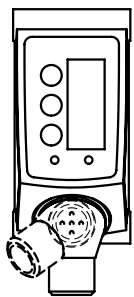





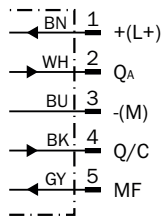



### Connection diagram





Cd-435



### Recommended accessories

Other models and accessories → [www.sick.com/AS30](http://www.sick.com/AS30)

	Brief description	Type	Part no.
<b>Connection modules</b>			
	IO-Link V1.1 Class A port, USB2.0 port, optional external power supply 24V / 1A	IOLA2US-01101 (SiLink2 Master)	1061790
<b>Universal bar clamp systems</b>			
	Plate K for universal clamp bracket, steel, zinc coated, Universal clamp (2022726), mounting hardware	BEF-KHS-K01	2022718
	Mounting bar, straight, 200 mm, steel, steel, zinc coated, without mounting hardware	BEF-MS12G-A	4056054
	Mounting bar, L-shaped, 150 mm x 150 mm, steel, steel, zinc coated, without mounting hardware	BEF-MS12L-A	4056052
<b>Mounting brackets and plates</b>			
	Aluminum, mounting hardware for the sensor included	BEF-AP-AS30	2124602
<b>Reflectors</b>			
	Fine triple, planar, suitable for laser sensors, 75 mm x 25 mm, PMMA/ABS, screwable	PL25FA	5340878
<b>Terminal and alignment brackets</b>			
	Holder for reflector foil (scope of delivery AS30) or accessory reflector. Simply align and set the correct scanning distance., steel, zinc coated, Reflector holder, screw set for AS30 and reflector PL25FA (5340878)	REFLECTORHOLDER SD25	2107380
	Bracket for easy mounting of ELA external illumination as a backlight. Suitable for all AS30 Prime with 25 mm sensing distance., steel, zinc coated, Mounting bracket, Screw set for AS30 and ELA	SET FORK HOLDER ELA SD25	2134662

	Brief description	Type	Part no.
	<ul style="list-style-type: none"> <li>• <b>Connection type head A:</b> Male connector, M12, 5-pin, straight, A-coded</li> <li>• <b>Description:</b> Unshielded, Head A: male connector, M12, 5-pin, straight, unshielded, for cable diameter 4 mm ... 6 mm Head B: -</li> <li>• <b>Connection systems:</b> Screw-type terminals</li> <li>• <b>Permitted cross-section:</b> ≤ 0.75 mm<sup>2</sup></li> <li>• <b>Note:</b> For field bus technology</li> </ul>	STE-1205-G	6022083
	<ul style="list-style-type: none"> <li>• <b>Connection type head A:</b> Female connector, M12, 5-pin, straight, A-coded</li> <li>• <b>Connection type head B:</b> Flying leads</li> <li>• <b>Signal type:</b> Sensor/actuator cable</li> <li>• <b>Cable:</b> 5 m, 5-wire, PVC</li> <li>• <b>Description:</b> Sensor/actuator cable, unshielded</li> <li>• <b>Application:</b> Zones with chemicals, Uncontaminated zones</li> </ul>	YF2A15-050VB5XLEAX	2096240
Sensor Integration Gateway			
	<ul style="list-style-type: none"> <li>• <b>Further functions:</b> Web server integrated, USB connection for easy configuration of the SIG200 Sensor Integration Gateway with SOPAS ET, the engineering tool from SICK, logic editor is available for easy configuration of logic functions</li> <li>• <b>Connection CONFIG:</b> 1 x M8, 4-pin female connector, USB 2.0 (USB-A)</li> <li>• <b>Logic editor:</b> yes</li> <li>• <b>Communication interface:</b> IO-Link, USB, Ethernet, PROFINET, REST API</li> <li>• <b>Product category:</b> IO-Link Master</li> </ul>	SIG200-0A04I2200	1089794
	<ul style="list-style-type: none"> <li>• <b>Further functions:</b> Web server integrated, USB connection for easy configuration of the SIG200 Sensor Integration Gateway with SOPAS ET, the engineering tool from SICK, logic editor is available for easy configuration of logic functions</li> <li>• <b>Connection CONFIG:</b> 1 x M8, 4-pin female connector, USB 2.0 (USB-A)</li> <li>• <b>Logic editor:</b> yes</li> <li>• <b>Communication interface:</b> IO-Link, USB, Ethernet, REST API</li> <li>• <b>Product category:</b> IO-Link Master</li> </ul>	SIG200-0A0G12200	1102605

## Recommended services

Additional services → [www.sick.com/AS30](http://www.sick.com/AS30)

	Type	Part no.
Function Block Factory		
<ul style="list-style-type: none"> <li>• <b>Description:</b> The Function Block Factory is an engineering tool for creating device and environment-specific function blocks that enable IO-Link sensors to be integrated into programmable logic controllers. The Function Block Factory supports common programmable logic controllers (PLCs) of various manufacturers such as Siemens, Beckhoff, Rockwell Automation B&amp;R and more. More information on the FBF can be found <a href="https://fbf.cloud.sick.com" target="_blank">here</a>.</li> <li>• <b>Provision:</b> Customers can obtain access to the Function Block Factory and the license via <a href="https://fbf.cloud.sick.com" target="_blank">https://fbf.cloud.sick.com</a>.</li> </ul>	Function Block Factory	On request

## SICK AT A GLANCE

SICK is one of the leading manufacturers of intelligent sensors and sensor solutions for industrial applications. A unique range of products and services creates the perfect basis for controlling processes securely and efficiently, protecting individuals from accidents and preventing damage to the environment.

We have extensive experience in a wide range of industries and understand their processes and requirements. With intelligent sensors, we can deliver exactly what our customers need. In application centers in Europe, Asia and North America, system solutions are tested and optimized in accordance with customer specifications. All this makes us a reliable supplier and development partner.

Comprehensive services complete our offering: SICK LifeTime Services provide support throughout the machine life cycle and ensure safety and productivity.

For us, that is “Sensor Intelligence.”

## WORLDWIDE PRESENCE:

Contacts and other locations –[www.sick.com](http://www.sick.com)