

BCG19-P1BM1015

EcoLine

WIRE DRAW ENCODERS

SICK
Sensor Intelligence.

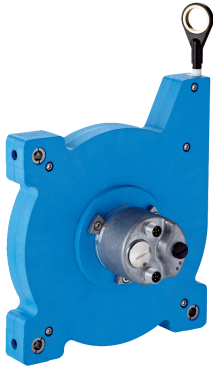

Ordering information

Type	Part no.
BCG19-P1BM1015	1052620

Included in delivery: A3M60B-S1PB013x13 (1), MRA-G190-110D3 (1)

Product is supplied fully assembled. See individual components for further technical data

Other models and accessories → www.sick.com/EcoLine



Detailed technical data

Performance

Measurement range	0 m ... 10 m
Encoder	Absolute encoders
Resolution (wire draw + encoder)	0.07 mm ^{1) 2)}
Repeatability	≤ 0.2 mm ³⁾
Linearity	≤ ± 2 mm ³⁾
Hysteresis	≤ 0.4 mm ³⁾

¹⁾ The values shown have been rounded.

²⁾ Example calculation based on the BCG08 with PROFINET: 230 mm (wire draw length per revolution - see Mechanical data): 262,144 (number of steps per revolution) = 0.001 mm (resolution of wire draw + encoder combination).

³⁾ Value applies to wire draw mechanism.

Interfaces

Communication interface	PROFIBUS DP
Programmable/configurable	✓

Electrical data

Connection type	Male connector, Female connector, 2x, 1x, M12, M12, 5-pin, 5-pin, axial, axial
Supply voltage	10 V ... 32 V
Power consumption	≤ 1.5 W (without load)
MTTFd: mean time to dangerous failure	60 years (EN ISO 13849-1) ¹⁾

¹⁾ This product is a standard product and does not constitute a safety component as defined in the Machinery Directive. Calculation based on nominal load of components, average ambient temperature 40 °C, frequency of use 8760 h/a. All electronic failures are considered hazardous. For more information, see document no. 8015532.

Mechanical data

Weight	2.18 kg
---------------	---------

¹⁾ These values were measured at an ambient temperature of 25 °C. There may be variations at other temperatures.

²⁾ Average values, which depend on the application.

³⁾ The service life depends on the type of load. This is influenced by environmental conditions, the installation location, the measuring range in use, the traversing speed, and acceleration.

Measuring wire material	Highly flexible stranded steel 1,4401 stainless steel V4A
Measuring wire diameter	0.55 mm
Weight (measuring wire)	7.1 g/m
Housing material, wire draw mechanism	Plastic, Noryl
Spring return force	9 N ... 12 N ¹⁾
Length of wire pulled out per revolution	555 mm
Life of wire draw mechanism	Typ. 1,000,000 cycles ^{2) 3)}
Actual wire draw length	10.2 m
Wire acceleration	8 m/s ²
Operating speed	3 m/s
Mounted encoder	A3M60, A3M60B-S1PB013X13, 1051018
Mounted mechanic	MRA-G190-110D3, 5326242

¹⁾ These values were measured at an ambient temperature of 25 °C. There may be variations at other temperatures.

²⁾ Average values, which depend on the application.

³⁾ The service life depends on the type of load. This is influenced by environmental conditions, the installation location, the measuring range in use, the traversing speed, and acceleration.

Ambient data

EMC	According to EN 61000-6-2 and EN 61000-6-3
Enclosure rating	IP50, mounted mechanic IP67, Encoder (IEC 60529) ¹⁾
Operating temperature range	-10 °C ... +70 °C

¹⁾ For devices with male connector: with mounted mating connector.

Classifications



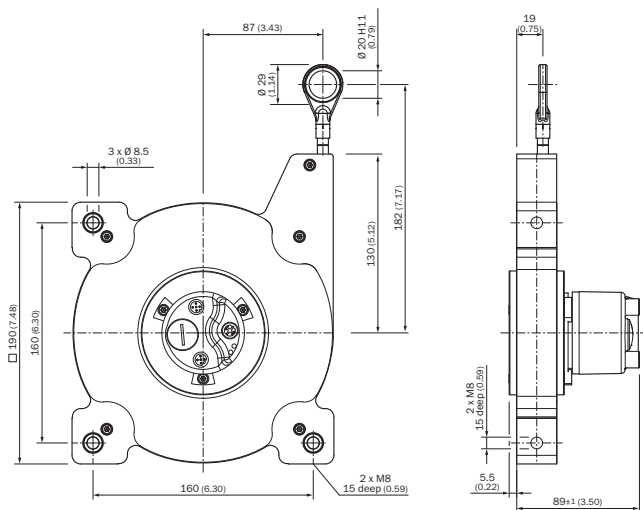

ECLASS 5.0	27270590
ECLASS 5.1.4	27270590
ECLASS 6.0	27270590
ECLASS 6.2	27270590
ECLASS 7.0	27270590
ECLASS 8.0	27270590
ECLASS 8.1	27270590
ECLASS 9.0	27270590
ECLASS 10.0	27270613
ECLASS 11.0	27270503
ECLASS 12.0	27270503
ETIM 5.0	EC001486
ETIM 6.0	EC001486
ETIM 7.0	EC001486
ETIM 8.0	EC001486
UNSPSC 16.0901	41112113

Dimensional drawing (Dimensions in mm (inch))





Recommended accessories

Other models and accessories → www.sick.com/EcoLine

	Brief description	Type	Part no.
Spare parts			
	Spare mounting set for MRA-G190 (10 m EcoLine)	BEF-MK-MRA-G01	5326294
Wire draw mechanism			
	EcoLine wire draw mechanism for servo flange with 6 mm shaft, measuring range 0 m ... 10 m	MRA-G190-110D3	5326242
Flanges			
	Flange adapter for EcoLine wire draw mechanisms, adaption of face mount flange with centering hub 20 mm to 50 mm servo flange, Aluminum, including 3 countersunk screws M3 x 10	BEF-FA-020-050-007	2073774
Plug connectors and cables			
	<ul style="list-style-type: none"> • Connection type head A: Flying leads • Connection type head B: Flying leads • Signal type: PROFIBUS DP • Cable: 2-wire, PUR • Description: PROFIBUS DP, shielded 	LTG-2102-MW	6021355
	<ul style="list-style-type: none"> • Connection type head A: Female connector, M12, 5-pin, angled, A-coded • Connection type head B: Flying leads • Signal type: Sensor/actuator cable • Cable: 5 m, 2-wire, PUR, halogen-free • Description: Sensor/actuator cable, unshielded, Head A: female connector, M12, 5-pin, angled Head B: cable Cable: for power supply, PUR, halogen-free, shielded, 3 x 0.34 mm², Ø 4.2 mm • Note: Voltage supply • Application: Zones with oils and lubricants 	DOL-1202-W05MC	6042067

	Brief description	Type	Part no.	
	<ul style="list-style-type: none"> • Connection type head A: Female connector, M12, 5-pin, angled, A-coded • Connection type head B: Flying leads • Signal type: Sensor/actuator cable • Cable: 10 m, 2-wire, PUR, halogen-free • Description: Sensor/actuator cable, unshielded • Note: Voltage supply • Application: Zones with oils and lubricants 	DOL-1202-W10MC	6042068	
	<ul style="list-style-type: none"> • Connection type head A: Female connector, M12, 5-pin, straight, A-coded • Connection type head B: Flying leads • Signal type: Sensor/actuator cable • Cable: 5 m, 5-wire, PUR, halogen-free • Description: Sensor/actuator cable, shielded • Application: Zones with oils and lubricants, Drag chain operation, Robot 	YF2A25-050UB6XLEAX	2095733	
	<ul style="list-style-type: none"> • Connection type head A: Female connector, M12, 5-pin, straight, A-coded • Connection type head B: Flying leads • Signal type: Sensor/actuator cable • Cable: 10 m, 5-wire, PUR, halogen-free • Description: Sensor/actuator cable, shielded • Application: Zones with oils and lubricants, Drag chain operation, Robot 	YF2A25-100UB6XLEAX	2095734	
	<ul style="list-style-type: none"> • Connection type head A: Female connector, M12, 5-pin, straight, A-coded • Connection type head B: Flying leads • Signal type: Sensor/actuator cable • Cable: 20 m, 5-wire, PUR, halogen-free • Description: Sensor/actuator cable, shielded • Application: Zones with oils and lubricants, Drag chain operation, Robot 	YF2A25-200UB6XLEAX	2095738	
	<ul style="list-style-type: none"> • Connection type head A: Female connector, M12, 2-pin, straight, B-coded • Connection type head B: Flying leads • Signal type: Fieldbus, PROFIBUS DP • Cable: 5 m, 2-wire, PUR, halogen-free • Description: Fieldbus, PROFIBUS DP, shielded • Application: Drag chain operation, Zones with oils and lubricants 	YF2B22-050PB1XLEAX	2121936	
	<ul style="list-style-type: none"> • Connection type head A: Female connector, M12, 2-pin, straight, B-coded • Connection type head B: Flying leads • Signal type: Fieldbus, PROFIBUS DP • Cable: 10 m, 2-wire, PUR, halogen-free • Description: Fieldbus, PROFIBUS DP, shielded • Application: Drag chain operation, Zones with oils and lubricants 	YF2B22-100PB1XLEAX	2106269	
	<ul style="list-style-type: none"> • Connection type head A: Female connector, M12, 2-pin, straight, B-coded • Connection type head B: Flying leads • Signal type: Fieldbus, PROFIBUS DP • Cable: 15 m, 2-wire, PUR, halogen-free • Description: Fieldbus, PROFIBUS DP, shielded • Application: Drag chain operation, Zones with oils and lubricants 	YF2B22-150PB1XLEAX	2106272	
	<ul style="list-style-type: none"> • Connection type head A: Female connector, M12, 2-pin, straight, B-coded • Connection type head B: Flying leads • Signal type: Fieldbus, PROFIBUS DP • Cable: 20 m, 2-wire, PUR, halogen-free • Description: Fieldbus, PROFIBUS DP, shielded • Application: Drag chain operation, Zones with oils and lubricants 	YF2B22-200PB1XLEAX	2106273	
	<ul style="list-style-type: none"> • Connection type head A: Female connector, M12, 2-pin, angled, B-coded • Connection type head B: Flying leads • Signal type: Fieldbus, PROFIBUS DP • Cable: 5 m, 2-wire, PUR, halogen-free • Description: Fieldbus, PROFIBUS DP, shielded • Application: Drag chain operation, Zones with oils and lubricants 	YG2B22-050PB1XLEAX	2106274	
		<ul style="list-style-type: none"> • Connection type head A: Female connector, M12, 2-pin, angled, B-coded • Connection type head B: Flying leads • Signal type: Fieldbus, PROFIBUS DP • Cable: 10 m, 2-wire, PUR, halogen-free • Description: Fieldbus, PROFIBUS DP, shielded • Application: Drag chain operation, Zones with oils and lubricants 	YG2B22-100PB1XLEAX	2106275

	Brief description	Type	Part no.
	<ul style="list-style-type: none"> • Connection type head A: Male connector, M12, 2-pin, straight, B-coded • Connection type head B: Flying leads • Signal type: Fieldbus, PROFIBUS DP • Cable: 5 m, 2-wire, PUR, halogen-free • Description: Fieldbus, PROFIBUS DP, shielded • Application: Drag chain operation, Zones with oils and lubricants 	YM2B22-050PB1XLEAX	2106270
	<ul style="list-style-type: none"> • Connection type head A: Male connector, M12, 2-pin, straight, B-coded • Connection type head B: Flying leads • Signal type: Fieldbus, PROFIBUS DP • Cable: 10 m, 2-wire, PUR, halogen-free • Description: Fieldbus, PROFIBUS DP, shielded • Application: Drag chain operation, Zones with oils and lubricants 	YM2B22-100PB1XLEAX	2106271
	<ul style="list-style-type: none"> • Connection type head A: Male connector, M12, 2-pin, straight, B-coded • Connection type head B: Flying leads • Signal type: Fieldbus, PROFIBUS DP • Cable: 15 m, 2-wire, PUR, halogen-free • Description: Fieldbus, PROFIBUS DP, shielded • Application: Drag chain operation, Zones with oils and lubricants 	YM2B22-150PB1XLEAX	2106276
	<ul style="list-style-type: none"> • Connection type head A: Male connector, M12, 2-pin, angled, B-coded • Connection type head B: Flying leads • Signal type: Fieldbus, PROFIBUS DP • Cable: 5 m, 2-wire, PUR, halogen-free • Description: Fieldbus, PROFIBUS DP, shielded • Application: Drag chain operation, Zones with oils and lubricants 	YN2B22-050PB1XLEAX	2106277
	<ul style="list-style-type: none"> • Connection type head A: Male connector, M12, 2-pin, angled, B-coded • Connection type head B: Flying leads • Signal type: Fieldbus, PROFIBUS DP • Cable: 10 m, 2-wire, PUR, halogen-free • Description: Fieldbus, PROFIBUS DP, shielded • Application: Drag chain operation, Zones with oils and lubricants 	YN2B22-100PB1XLEAX	2106278
	<ul style="list-style-type: none"> • Connection type head A: Female connector, M12, 5-pin, straight, B-coded • Connection type head B: Male connector, M12, 5-pin, straight, B-coded • Signal type: PROFIBUS DP • Cable: 10 m, 2-wire, PUR, halogen-free • Description: PROFIBUS DP, twisted pair, shielded • Note: Wire shield Al-Pt film, overall shield C-screen tin-plated • Application: Zones with oils and lubricants, Drag chain operation 	DSL-1205-G10MQ	6032640
	<ul style="list-style-type: none"> • Connection type head A: Female connector, M12, 4-pin, straight • Description: Unshielded, Head A: female connector, M12, 4-pin, straight, unshielded, for power supply, for cable diameter 4 mm ... 6 mm Head B: - • Connection systems: Screw-type terminals • Permitted cross-section: ≤ 0.75 mm² 	DOS-1204-G	6007302
	<ul style="list-style-type: none"> • Connection type head A: Female connector, M12, 4-pin, angled • Description: Unshielded, Head A: female connector, M12, 4-pin, angled, unshielded, for power supply, for cable diameter 3 mm ... 6.5 mm Head B: - • Connection systems: Screw-type terminals • Permitted cross-section: ≤ 0.75 mm² 	DOS-1204-W	6007303
	<ul style="list-style-type: none"> • Connection type head A: Female connector, M12, 5-pin, straight, B-coded • Signal type: PROFIBUS DP • Description: PROFIBUS DP, shielded, Head A: M12 female connector, 5-pin, straight, B-coded, PROFIBUS DP, shielded, for cable diameter 4 mm ... 9 mm Head B: - • Connection systems: Screw-type terminals • Permitted cross-section: ≤ 0.75 mm² 	DOS-1205-GQ	6021353
	<ul style="list-style-type: none"> • Connection type head A: Female connector, M12, 5-pin, angled, B-coded (B-inverse) • Signal type: PROFIBUS DP, PROFIBUS DP • Description: PROFIBUS DP, PROFIBUS DP, shielded, Head A: female connector, M12, 5-pin, angled, B-coded, shielded, for cable diameter 4 mm ... 8 mm Head B: - • Connection systems: Spring-cage connection • Permitted cross-section: 0.14 mm² ... 0.5 mm² 	DOS-1205-WQ	6041429

	Brief description	Type	Part no.
	<ul style="list-style-type: none"> • Connection type head A: Male connector, M12, 5-pin, straight, B-coded • Signal type: PROFIBUS DP • Description: PROFIBUS DP, shielded, Head A: male connector, M12, 5-pin, straight, B coded, shielded, for cable diameter 4 mm ... 9 mm Head B: - • Connection systems: Screw-type terminals • Permitted cross-section: ≤ 0.75 mm² 	STE-1205-GQ	6021354
	<ul style="list-style-type: none"> • Connection type head A: Male connector, M12, 5-pin, angled, B-coded • Signal type: PROFIBUS DP • Description: PROFIBUS DP, shielded, Head A: male connector, M12, 5-pin, angled, B coded, shielded, for cable diameter 4 mm ... 8 mm Head B: - • Connection systems: Spring-cage connection • Permitted cross-section: 0.14 mm² ... 0.5 mm² 	STE-1205-WQ	6041428
	<ul style="list-style-type: none"> • Description: Unshielded, A3M60 accessories sales set comprising: Female cable connector, supply voltage, M12, angled (6007303) female cable connector, M12, angled (6041429), male cable connector, M12, angled (6041428) • Note: Set of connectors 	DOS-3XM12-W	2058177
	<ul style="list-style-type: none"> • Connection type head A: Male connector, M12, 4-pin, straight, B-coded • Signal type: PROFIBUS DP • Description: PROFIBUS DP, terminal resistor 	STE-END-Q	6021156

SICK AT A GLANCE

SICK is one of the leading manufacturers of intelligent sensors and sensor solutions for industrial applications. A unique range of products and services creates the perfect basis for controlling processes securely and efficiently, protecting individuals from accidents and preventing damage to the environment.

We have extensive experience in a wide range of industries and understand their processes and requirements. With intelligent sensors, we can deliver exactly what our customers need. In application centers in Europe, Asia and North America, system solutions are tested and optimized in accordance with customer specifications. All this makes us a reliable supplier and development partner.

Comprehensive services complete our offering: SICK LifeTime Services provide support throughout the machine life cycle and ensure safety and productivity.

For us, that is “Sensor Intelligence.”

WORLDWIDE PRESENCE:

Contacts and other locations –www.sick.com