



# BTF19-I1BM5099

HighLine

WIRE DRAW ENCODERS

**SICK**  
Sensor Intelligence.

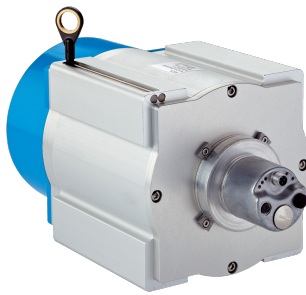

### Ordering information

| Type           | Part no. |
|----------------|----------|
| BTF19-I1BM5099 | 1061011  |

**Included in delivery:** AFM60A-S1IB018x12 (1), MRA-F190-150D2 (1)

Product is supplied fully assembled. See individual components for further technical data

Other models and accessories → [www.sick.com/HighLine](http://www.sick.com/HighLine)



### Detailed technical data

#### Performance

|   |                           |
|---|---------------------------|
| <b>Measurement range</b>                | 0 m ... 50 m              |
| <b>Encoder</b>                          | Absolute encoders         |
| <b>Resolution (wire draw + encoder)</b> | 0.002 mm <sup>1) 2)</sup> |
| <b>Repeatability</b>                    | ≤ 5 mm <sup>3)</sup>      |
| <b>Linearity</b>                        | ≤ ± 2 mm <sup>3)</sup>    |
| <b>Hysteresis</b>                       | ≤ 10 mm <sup>3)</sup>     |

<sup>1)</sup> The values shown have been rounded.

<sup>2)</sup> Example calculation based on the BTF08 with PROFINET: 200 mm (wire draw length per revolution - see Mechanical data): 262,144 (number of steps per revolution) = 0.001 mm (resolution of wire draw + encoder combination).

<sup>3)</sup> Value applies to wire draw mechanism.

#### Interfaces

|                                  |              |
|----------------------------------|--------------|
| <b>Communication interface</b>   | EtherNet/IP™ |
| <b>Programmable/configurable</b> | ✓            |

#### Electrical data

|  |  |
|--|--|
| <b>Connection type</b>                       | Male connector, Female connector, 1x, 2x, M12, M12, 4-pin, 4-pin, axial, axial |
| <b>Supply voltage</b>                        | 10 V DC ... 30 V DC  |
| <b>Power consumption</b>                     | ≤ 3 W (without load)   |
| <b>MTTFd: mean time to dangerous failure</b> | 80 years (EN ISO 13849-1) <sup>1)</sup>  |

<sup>1)</sup> This product is a standard product and does not constitute a safety component as defined in the Machinery Directive. Calculation based on nominal load of components, average ambient temperature 40 °C, frequency of use 8760 h/a. All electronic failures are considered hazardous. For more information, see document no. 8015532.

#### Mechanical data

|                                |   |
|--------------------------------|---|
| <b>Weight</b>                  | 16.7 kg   |
| <b>Measuring wire material</b> | Highly flexible stranded steel 1,4401 stainless steel V4A |
| <b>Measuring wire diameter</b> | 1.35 mm   |

<sup>1)</sup> These values were measured at an ambient temperature of 25 °C. There may be variations at other temperatures.

<sup>2)</sup> Average values, which depend on the application.

<sup>3)</sup> The service life depends on the type of load. This is influenced by environmental conditions, the installation location, the measuring range in use, the traversing speed, and acceleration.

|   |  |
|---|--|
| <b>Weight (measuring wire)</b>                  | 7.1 g/m  |
| <b>Housing material, wire draw mechanism</b>    | Aluminum (anodized), aluminum die cast (nickel-plated) |
| <b>Spring return force</b>                      | 18 N ... 37 N <sup>1)</sup>                            |
| <b>Length of wire pulled out per revolution</b> | 491.5 mm   |
| <b>Life of wire draw mechanism</b>              | Typ. 1,000,000 cycles <sup>2) 3)</sup>                 |
| <b>Actual wire draw length</b>                  | 50.2 m   |
| <b>Wire acceleration</b>                        | 18 m/s <sup>2</sup>                                    |
| <b>Operating speed</b>                          | 4 m/s  |
| <b>Mounted encoder</b>                          | AFM60 EtherNet/IP, AFM60A-S1IB018X12, 1055331          |
| <b>Mounted mechanic</b>                         | MRA-F190-150D2, 6028630                                |

<sup>1)</sup> These values were measured at an ambient temperature of 25 °C. There may be variations at other temperatures.

<sup>2)</sup> Average values, which depend on the application.

<sup>3)</sup> The service life depends on the type of load. This is influenced by environmental conditions, the installation location, the measuring range in use, the traversing speed, and acceleration.

### Ambient data

|                                    |   |
|------------------------------------|---|
| <b>EMC</b>                         | According to EN 61000-6-2 and EN 61000-6-3 <sup>1)</sup>          |
| <b>Enclosure rating</b>            | IP31, mounted mechanic<br>IP67, Encoder (IEC 60529) <sup>2)</sup> |
| <b>Operating temperature range</b> | -30 °C ... +70 °C   |

<sup>1)</sup> EMC according to the standards quoted is achieved if shielded cables are used.

<sup>2)</sup> With mating connector fitted.

### Classifications

|                       |          |
|-----------------------|----------|
| <b>ECLASS 5.0</b>     | 27270590 |
| <b>ECLASS 5.1.4</b>   | 27270590 |
| <b>ECLASS 6.0</b>     | 27270590 |
| <b>ECLASS 6.2</b>     | 27270590 |
| <b>ECLASS 7.0</b>     | 27270590 |
| <b>ECLASS 8.0</b>     | 27270590 |
| <b>ECLASS 8.1</b>     | 27270590 |
| <b>ECLASS 9.0</b>     | 27270590 |
| <b>ECLASS 10.0</b>    | 27270613 |
| <b>ECLASS 11.0</b>    | 27270503 |
| <b>ECLASS 12.0</b>    | 27270503 |
| <b>ETIM 5.0</b>       | EC001486 |
| <b>ETIM 6.0</b>       | EC001486 |
| <b>ETIM 7.0</b>       | EC001486 |
| <b>ETIM 8.0</b>       | EC001486 |
| <b>UNSPSC 16.0901</b> | 41112113 |

### Dimensional drawing (Dimensions in mm (inch))

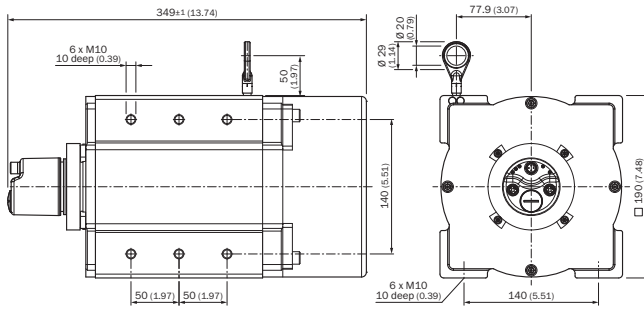

### PIN assignment

Male connector

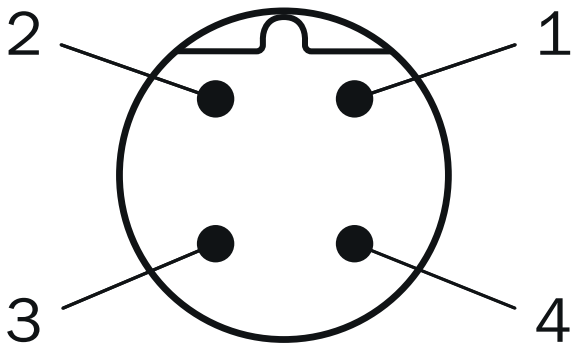

Supply voltage

| PIN | Signal        |
|-----|---------------|
| 1   | 10 V ... 30 V |
| 2   | Not assigned  |
| 3   | GND           |
| 4   | Not assigned  |

Female connector

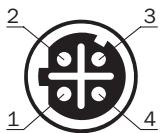

Port 1, Port 2



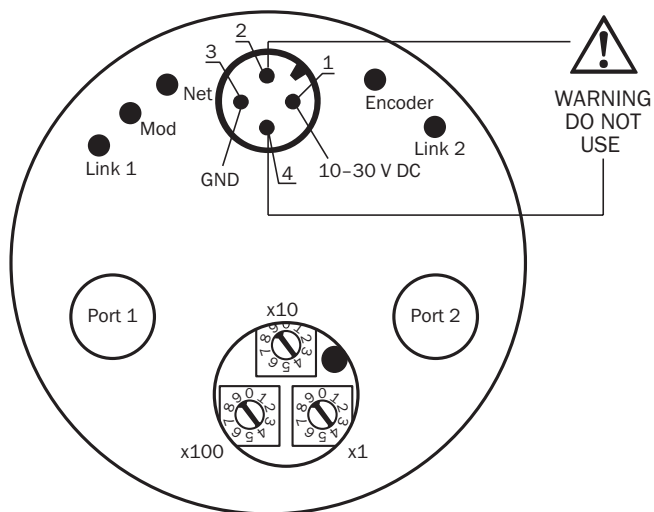

| PIN | Signal |
|-----|--------|
| 1   | T x D+ |
| 2   | R x D+ |
| 3   | T x D- |
| 4   | R x D- |



Connection diagram









Recommended accessories

Other models and accessories → [www.sick.com/HighLine](http://www.sick.com/HighLine)

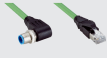
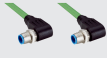

|   | Brief description   | Type                                       | Part no. |
|---|---|--|----------|
| <b>Wire draw mechanism</b>  |   |  |          |
|  | HighLine wire draw mechanism for servo flange with 6 mm shaft, measuring range 0 m ... 50 m   | MRA-F190-150D2                             | 6028630  |
| <b>Flanges</b>  |   |  |          |
|  | Flange adapter for HighLine wire draw mechanisms, adaption of face mount flange with centering hub 20 mm to 50 mm servo flange, Aluminum, including 3 countersunk screws M3 x 10  | BEF-FA-020-050WDE                          | 2073776  |
| <b>Other mounting accessories</b>   |   |  |          |
|  | Joint ball for later insertion in wire end ring with 20 mm diameter. The use of this joint ball enables movement in multiple levels of freedom.   | Joint protection for wire rope BTF/PRF/MRA | 5318683  |
|  | Compressed air attachment for MRA-F080... and MRA-F130... HighLine wire draw mechanism  | MRA-F-P                                    | 6073769  |
| <b>Plug connectors and cables</b>   |   |  |          |
|  | <ul style="list-style-type: none"> <li><b>Connection type head A:</b> Male connector, M12, 4-pin, straight, D-coded</li> <li><b>Connection type head B:</b> Flying leads</li> <li><b>Signal type:</b> Ethernet</li> <li><b>Cable:</b> 2 m, 4-wire, CAT5, CAT5e, PUR, halogen-free</li> <li><b>Description:</b> Ethernet, shielded, M12 male connector D-coded straight to open end</li> </ul> | STL-1204-G02ME90                           | 6045284  |
|   | <ul style="list-style-type: none"> <li><b>Connection type head A:</b> Male connector, M12, 4-pin, straight, D-coded</li> <li><b>Connection type head B:</b> Flying leads</li> <li><b>Signal type:</b> Ethernet</li> <li><b>Cable:</b> 5 m, 4-wire, CAT5, CAT5e, PUR, halogen-free</li> <li><b>Description:</b> Ethernet, shielded, M12 male connector D-coded straight to open end</li> </ul> | STL-1204-G05ME90                           | 6045285  |

|   | Brief description   | Type   | Part no.           |
|---|---|--|--------------------|
|  | <ul style="list-style-type: none"> <li><b>Connection type head A:</b> Male connector, M12, 4-pin, straight, D-coded</li> <li><b>Connection type head B:</b> Flying leads</li> <li><b>Signal type:</b> Ethernet</li> <li><b>Cable:</b> 10 m, 4-wire, CAT5, CAT5e, PUR, halogen-free</li> <li><b>Description:</b> Ethernet, shielded, M12 male connector D-coded straight to open end</li> </ul>  | STL-1204-G10ME90   | 6045286            |
|   | <ul style="list-style-type: none"> <li><b>Connection type head A:</b> Male connector, M12, 4-pin, angled, D-coded</li> <li><b>Connection type head B:</b> Flying leads</li> <li><b>Signal type:</b> Ethernet</li> <li><b>Cable:</b> 2 m, 4-wire, CAT5, CAT5e, PUR, halogen-free</li> <li><b>Description:</b> Ethernet, shielded, M12 male connector D-coded angled to open end</li> </ul>   | STL-1204-W02ME90   | 6047912            |
|   | <ul style="list-style-type: none"> <li><b>Connection type head A:</b> Male connector, M12, 4-pin, angled, D-coded</li> <li><b>Connection type head B:</b> Flying leads</li> <li><b>Signal type:</b> Ethernet</li> <li><b>Cable:</b> 10 m, 4-wire, CAT5, CAT5e, PUR, halogen-free</li> <li><b>Description:</b> Ethernet, shielded, M12 male connector D-coded angled to open end</li> </ul>  | STL-1204-W10ME90   | 6047914            |
|   | <ul style="list-style-type: none"> <li><b>Connection type head A:</b> Male connector, M12, 4-pin, angled, D-coded</li> <li><b>Connection type head B:</b> Flying leads</li> <li><b>Signal type:</b> Ethernet</li> <li><b>Cable:</b> 25 m, 4-wire, CAT5, CAT5e, PUR, halogen-free</li> <li><b>Description:</b> Ethernet, shielded, M12 male connector D-coded angled to open end</li> </ul>  | STL-1204-W25ME90   | 6047915            |
|  | <ul style="list-style-type: none"> <li><b>Connection type head A:</b> Female connector, M12, 4-pin, straight, A-coded</li> <li><b>Connection type head B:</b> Flying leads</li> <li><b>Signal type:</b> Sensor/actuator cable</li> <li><b>Cable:</b> 2 m, 4-wire, PUR, halogen-free</li> <li><b>Description:</b> Sensor/actuator cable, unshielded</li> <li><b>Application:</b> Zones with oils and lubricants, Drag chain operation, Robot</li> </ul>  | YF2A14-020UB3XLEAX   | 2095607            |
|   | <ul style="list-style-type: none"> <li><b>Connection type head A:</b> Female connector, M12, 4-pin, straight, A-coded</li> <li><b>Connection type head B:</b> Flying leads</li> <li><b>Signal type:</b> Sensor/actuator cable</li> <li><b>Cable:</b> 5 m, 4-wire, PUR, halogen-free</li> <li><b>Description:</b> Sensor/actuator cable, unshielded</li> <li><b>Application:</b> Zones with oils and lubricants, Drag chain operation, Robot</li> </ul>  | YF2A14-050UB3XLEAX   | 2095608            |
|   | <ul style="list-style-type: none"> <li><b>Connection type head A:</b> Female connector, M12, 4-pin, straight, A-coded</li> <li><b>Connection type head B:</b> Flying leads</li> <li><b>Signal type:</b> Sensor/actuator cable</li> <li><b>Cable:</b> 10 m, 4-wire, PUR, halogen-free</li> <li><b>Description:</b> Sensor/actuator cable, unshielded</li> <li><b>Application:</b> Zones with oils and lubricants, Drag chain operation, Robot</li> </ul> | YF2A14-100UB3XLEAX   | 2095609            |
|   | <ul style="list-style-type: none"> <li><b>Connection type head A:</b> Female connector, M12, 4-pin, straight, A-coded</li> <li><b>Connection type head B:</b> Flying leads</li> <li><b>Signal type:</b> Sensor/actuator cable</li> <li><b>Cable:</b> 25 m, 4-wire, PUR, halogen-free</li> <li><b>Description:</b> Sensor/actuator cable, unshielded</li> <li><b>Application:</b> Zones with oils and lubricants, Drag chain operation, Robot</li> </ul> | YF2A14-250UB3XLEAX   | 2095615            |
|   | <ul style="list-style-type: none"> <li><b>Connection type head A:</b> Female connector, M12, 4-pin, angled, A-coded</li> <li><b>Connection type head B:</b> Flying leads</li> <li><b>Signal type:</b> Sensor/actuator cable</li> <li><b>Cable:</b> 2 m, 4-wire, PUR, halogen-free</li> <li><b>Description:</b> Sensor/actuator cable, unshielded</li> <li><b>Application:</b> Zones with oils and lubricants, Drag chain operation, Robot</li> </ul>    | YG2A14-020UB3XLEAX   | 2095766            |
|   | <ul style="list-style-type: none"> <li><b>Connection type head A:</b> Female connector, M12, 4-pin, angled, A-coded</li> <li><b>Connection type head B:</b> Flying leads</li> <li><b>Signal type:</b> Sensor/actuator cable</li> <li><b>Cable:</b> 5 m, 4-wire, PUR, halogen-free</li> <li><b>Description:</b> Sensor/actuator cable, unshielded</li> <li><b>Application:</b> Zones with oils and lubricants, Drag chain operation, Robot</li> </ul>    | YG2A14-050UB3XLEAX   | 2095767            |
|   |    | <ul style="list-style-type: none"> <li><b>Connection type head A:</b> Female connector, M12, 4-pin, angled, A-coded</li> <li><b>Connection type head B:</b> Flying leads</li> <li><b>Signal type:</b> Sensor/actuator cable</li> <li><b>Cable:</b> 5 m, 4-wire, PUR, halogen-free</li> <li><b>Description:</b> Sensor/actuator cable, unshielded</li> <li><b>Application:</b> Zones with oils and lubricants, Drag chain operation, Robot</li> </ul> | YG2A14-050UB3XLEAX |

|   | Brief description  | Type               | Part no. |
|---|--|--------------------|----------|
|   | <ul style="list-style-type: none"> <li>• <b>Connection type head A:</b> Female connector, M12, 4-pin, angled, A-coded</li> <li>• <b>Connection type head B:</b> Flying leads</li> <li>• <b>Signal type:</b> Sensor/actuator cable</li> <li>• <b>Cable:</b> 10 m, 4-wire, PUR, halogen-free</li> <li>• <b>Description:</b> Sensor/actuator cable, unshielded</li> <li>• <b>Application:</b> Zones with oils and lubricants, Drag chain operation, Robot</li> </ul>                  | YG2A14-100UB3XLEAX | 2095768  |
|   | <ul style="list-style-type: none"> <li>• <b>Connection type head A:</b> Female connector, M12, 4-pin, angled, A-coded</li> <li>• <b>Connection type head B:</b> Flying leads</li> <li>• <b>Signal type:</b> Sensor/actuator cable</li> <li>• <b>Cable:</b> 25 m, 4-wire, PUR, halogen-free</li> <li>• <b>Description:</b> Sensor/actuator cable, unshielded</li> <li>• <b>Application:</b> Zones with oils and lubricants, Drag chain operation, Robot</li> </ul>                  | YG2A14-250UB3XLEAX | 2095771  |
|    | <ul style="list-style-type: none"> <li>• <b>Connection type head A:</b> Male connector, M12, 4-pin, angled, D-coded</li> <li>• <b>Connection type head B:</b> Flying leads</li> <li>• <b>Signal type:</b> Ethernet, PROFINET</li> <li>• <b>Cable:</b> 5 m, 4-wire, PUR, halogen-free</li> <li>• <b>Description:</b> Ethernet, PROFINET, shielded</li> <li>• <b>Application:</b> Drag chain operation, Zones with oils and lubricants</li> </ul>                                    | YN2D24-050PN1XLEAX | 2106175  |
|    | <ul style="list-style-type: none"> <li>• <b>Connection type head A:</b> Male connector, M12, 4-pin, straight, D-coded</li> <li>• <b>Connection type head B:</b> Male connector, M12, 4-pin, straight, D-coded</li> <li>• <b>Signal type:</b> Ethernet</li> <li>• <b>Cable:</b> 5 m, 4-wire, CAT5, CAT5e, PUR, halogen-free</li> <li>• <b>Description:</b> Ethernet, shielded, 5 m cable, M12 male connector straight to M12 male connector straight</li> </ul>                     | SSL-1204-G05ME90   | 6045277  |
|   | <ul style="list-style-type: none"> <li>• <b>Connection type head A:</b> Male connector, M12, 4-pin, straight, D-coded</li> <li>• <b>Connection type head B:</b> Male connector, M12, 4-pin, straight, D-coded</li> <li>• <b>Signal type:</b> Ethernet</li> <li>• <b>Cable:</b> 10 m, 4-wire, CAT5, CAT5e, PUR, halogen-free</li> <li>• <b>Description:</b> Ethernet, shielded, 10 m cable, M12 male connector straight to M12 male connector straight</li> </ul>                   | SSL-1204-G10ME90   | 6045279  |
|  | <ul style="list-style-type: none"> <li>• <b>Connection type head A:</b> Male connector, M12, 4-pin, straight, D-coded</li> <li>• <b>Connection type head B:</b> Male connector, M12, 4-pin, straight, D-coded</li> <li>• <b>Signal type:</b> Ethernet, PROFINET</li> <li>• <b>Cable:</b> 2 m, 4-wire, PUR, halogen-free</li> <li>• <b>Description:</b> Ethernet, PROFINET, shielded</li> <li>• <b>Application:</b> Drag chain operation, Zones with oils and lubricants</li> </ul> | YM2D24-020PN1M2D24 | 2106159  |
|  | <ul style="list-style-type: none"> <li>• <b>Connection type head A:</b> Male connector, M12, 4-pin, straight, D-coded</li> <li>• <b>Connection type head B:</b> Male connector, RJ45, 4-pin, straight</li> <li>• <b>Signal type:</b> Ethernet, PROFINET</li> <li>• <b>Cable:</b> 2 m, 4-wire, PUR, halogen-free</li> <li>• <b>Description:</b> Ethernet, PROFINET, shielded</li> <li>• <b>Application:</b> Drag chain operation, Zones with oils and lubricants</li> </ul>         | YM2D24-020PN1MRJA4 | 2106182  |
|  | <ul style="list-style-type: none"> <li>• <b>Connection type head A:</b> Male connector, M12, 4-pin, straight, D-coded</li> <li>• <b>Connection type head B:</b> Male connector, RJ45, 8-pin, straight</li> <li>• <b>Signal type:</b> Ethernet</li> <li>• <b>Cable:</b> 5 m, 4-wire, AWG26, PUR, halogen-free</li> <li>• <b>Description:</b> Ethernet, twisted pair, shielded</li> </ul>  | YM2D24-050EA1MRJA4 | 6034415  |
|  | <ul style="list-style-type: none"> <li>• <b>Connection type head A:</b> Male connector, M12, 4-pin, straight, D-coded</li> <li>• <b>Connection type head B:</b> Male connector, RJ45, 4-pin, straight</li> <li>• <b>Signal type:</b> Ethernet, PROFINET</li> <li>• <b>Cable:</b> 5 m, 4-wire, PUR, halogen-free</li> <li>• <b>Description:</b> Ethernet, PROFINET, shielded</li> <li>• <b>Application:</b> Drag chain operation, Zones with oils and lubricants</li> </ul>         | YM2D24-050PN1MRJA4 | 2106184  |
|   | <ul style="list-style-type: none"> <li>• <b>Connection type head A:</b> Male connector, M12, 4-pin, straight, D-coded</li> <li>• <b>Connection type head B:</b> Male connector, RJ45, 4-pin, straight</li> <li>• <b>Signal type:</b> Ethernet, PROFINET</li> <li>• <b>Cable:</b> 10 m, 4-wire, PUR, halogen-free</li> <li>• <b>Description:</b> Ethernet, PROFINET, shielded</li> <li>• <b>Application:</b> Drag chain operation, Zones with oils and lubricants</li> </ul>        | YM2D24-100PN1MRJA4 | 2106185  |

|   | Brief description   | Type               | Part no. |
|---|---|--------------------|----------|
|    | <ul style="list-style-type: none"> <li>• <b>Connection type head A:</b> Male connector, M12, 4-pin, angled, D-coded</li> <li>• <b>Connection type head B:</b> Male connector, RJ45, 4-pin, straight</li> <li>• <b>Signal type:</b> Ethernet, PROFINET</li> <li>• <b>Cable:</b> 2 m, 4-wire, PUR, halogen-free</li> <li>• <b>Description:</b> Ethernet, PROFINET, shielded</li> <li>• <b>Application:</b> Drag chain operation, Zones with oils and lubricants</li> </ul>  | YN2D24-020PN1MRJA4 | 2106162  |
|    | <ul style="list-style-type: none"> <li>• <b>Connection type head A:</b> Male connector, M12, 4-pin, angled, D-coded</li> <li>• <b>Connection type head B:</b> Male connector, M12, 4-pin, angled, D-coded</li> <li>• <b>Signal type:</b> Ethernet, PROFINET</li> <li>• <b>Cable:</b> 2 m, 4-wire, PUR, halogen-free</li> <li>• <b>Description:</b> Ethernet, PROFINET, shielded</li> <li>• <b>Application:</b> Drag chain operation, Zones with oils and lubricants</li> </ul>  | YN2D24-020PN1N2D24 | 2106168  |
|    | <ul style="list-style-type: none"> <li>• <b>Connection type head A:</b> Male connector, M12, 4-pin, angled, D-coded</li> <li>• <b>Connection type head B:</b> Male connector, RJ45, 4-pin, straight</li> <li>• <b>Signal type:</b> Ethernet, PROFINET</li> <li>• <b>Cable:</b> 5 m, 4-wire, PUR, halogen-free</li> <li>• <b>Description:</b> Ethernet, PROFINET, shielded</li> <li>• <b>Application:</b> Drag chain operation, Zones with oils and lubricants</li> </ul>  | YN2D24-050PN1MRJA4 | 2106163  |
|   | <ul style="list-style-type: none"> <li>• <b>Connection type head A:</b> Male connector, M12, 4-pin, angled, D-coded</li> <li>• <b>Connection type head B:</b> Male connector, RJ45, 4-pin, straight</li> <li>• <b>Signal type:</b> Ethernet, PROFINET</li> <li>• <b>Cable:</b> 10 m, 4-wire, PUR, halogen-free</li> <li>• <b>Description:</b> Ethernet, PROFINET, shielded</li> <li>• <b>Application:</b> Drag chain operation, Zones with oils and lubricants</li> </ul>   | YN2D24-100PN1MRJA4 | 2106164  |
|    | <ul style="list-style-type: none"> <li>• <b>Connection type head A:</b> Female connector, M12, 4-pin, straight, D-coded</li> <li>• <b>Signal type:</b> Ethernet</li> <li>• <b>Cable:</b> CAT5, CAT5e</li> <li>• <b>Description:</b> Ethernet, shielded, Head A: female connector, M12, 4-pin, straight, D-coded, shielded, for cable diameter 4 mm ... 8 mm Head B: -</li> <li>• <b>Connection systems:</b> IDC quick connection</li> <li>• <b>Permitted cross-section:</b> 0.14 mm<sup>2</sup> ... 0.34 mm<sup>2</sup></li> </ul>    | DOS-1204-GE        | 6048153  |
|  | <ul style="list-style-type: none"> <li>• <b>Connection type head A:</b> Female connector, M12, 4-pin, angled</li> <li>• <b>Description:</b> Unshielded, Head A: female connector, M12, 4-pin, angled, unshielded, for power supply, for cable diameter 3 mm ... 6.5 mm Head B: -</li> <li>• <b>Connection systems:</b> Screw-type terminals</li> <li>• <b>Permitted cross-section:</b> ≤ 0.75 mm<sup>2</sup></li> </ul>   | DOS-1204-W         | 6007303  |
|  | <ul style="list-style-type: none"> <li>• <b>Connection type head A:</b> Female connector, M12, 4-pin, angled, D-coded</li> <li>• <b>Signal type:</b> Ethernet</li> <li>• <b>Cable:</b> CAT5, CAT5e</li> <li>• <b>Description:</b> Ethernet, shielded, Head A: female connector, M12, 4-pin, angled, D-coded, shielded, for cable diameter 4 mm ... 8 mm Head B: -</li> <li>• <b>Connection systems:</b> IDC quick connection</li> <li>• <b>Permitted cross-section:</b> 0.14 mm<sup>2</sup> ... 0.34 mm<sup>2</sup></li> </ul>        | DOS-1204-WE        | 6048154  |
|  | <ul style="list-style-type: none"> <li>• <b>Connection type head A:</b> Male connector, RJ45, 8-pin, straight</li> <li>• <b>Signal type:</b> EtherNet/IP™</li> <li>• <b>Cable:</b> CAT5, CAT5e</li> <li>• <b>Description:</b> EtherNet/IP™, shielded, Head A: male connector, RJ45, 8-pin, straight, shielded, EtherNet/IP, for cable diameter 4.5 mm ... 8 mm Head B: -</li> <li>• <b>Connection systems:</b> IDC quick connection</li> <li>• <b>Permitted cross-section:</b> 0.13 mm<sup>2</sup> ... 0.23 mm<sup>2</sup></li> </ul> | STE-0J08-GE        | 6048150  |
|  | <ul style="list-style-type: none"> <li>• <b>Connection type head A:</b> Male connector, M12, 4-pin, straight, D-coded</li> <li>• <b>Signal type:</b> Ethernet</li> <li>• <b>Cable:</b> CAT5, CAT5e</li> <li>• <b>Description:</b> Ethernet, shielded, Head A: male connector, M12, 4-pin, straight, D coded, shielded, for cable diameter 4 mm ... 8 mm Head B: -</li> <li>• <b>Connection systems:</b> IDC quick connection</li> <li>• <b>Permitted cross-section:</b> 0.14 mm<sup>2</sup> ... 0.34 mm<sup>2</sup></li> </ul>        | STE-1204-GE01      | 6048151  |



|   | Brief description  | Type                                       | Part no. |
|---|--|--|----------|
|  | <ul style="list-style-type: none"> <li>• <b>Connection type head A:</b> Male connector, M12, 4-pin, angled, D-coded</li> <li>• <b>Signal type:</b> Ethernet</li> <li>• <b>Cable:</b> CAT5, CAT5e</li> <li>• <b>Description:</b> Ethernet, shielded, Head A: male connector, M12, 4-pin, angled, D coded, shielded, for cable diameter 4 mm ... 8 mm Head B: -</li> <li>• <b>Connection systems:</b> IDC quick connection</li> <li>• <b>Permitted cross-section:</b> 0.14 mm<sup>2</sup> ... 0.34 mm<sup>2</sup></li> </ul> | STE-1204-WE                                | 6048152  |
|  | <ul style="list-style-type: none"> <li>• <b>Connection type head A:</b> Female connector, M12, 4-pin, D-coded</li> <li>• <b>Connection type head B:</b> Female connector, RJ45, 8-pin</li> <li>• <b>Signal type:</b> Ethernet</li> <li>• <b>Cable:</b> CAT5, CAT5e</li> <li>• <b>Description:</b> Ethernet, shielded</li> <li>• <b>Note:</b> Cabinet through</li> </ul>  | Feedthrough female connector Ethernet RJ45 | 6048180  |

## SICK AT A GLANCE

SICK is one of the leading manufacturers of intelligent sensors and sensor solutions for industrial applications. A unique range of products and services creates the perfect basis for controlling processes securely and efficiently, protecting individuals from accidents and preventing damage to the environment.

We have extensive experience in a wide range of industries and understand their processes and requirements. With intelligent sensors, we can deliver exactly what our customers need. In application centers in Europe, Asia and North America, system solutions are tested and optimized in accordance with customer specifications. All this makes us a reliable supplier and development partner.

Comprehensive services complete our offering: SICK LifeTime Services provide support throughout the machine life cycle and ensure safety and productivity.

For us, that is “Sensor Intelligence.”

## WORLDWIDE PRESENCE:

Contacts and other locations –[www.sick.com](http://www.sick.com)