



# C40S-1201DA010

C4000 Advanced

**SAFETY LIGHT CURTAINS**

**SICK**  
Sensor Intelligence.



### Ordering information

Resolution	Scanning range	Protective field height	System part	Type	Part no.
14 mm	10 m	1,200 mm	Sender	C40S-1201DA010	1018700

Other models and accessories → [www.sick.com/C4000\\_Advanced](http://www.sick.com/C4000_Advanced)

Illustration may differ



### Detailed technical data

#### Features

<b>Application</b>	Normal industrial environment
<b>System part</b>	Sender
<b>Resolution</b>	14 mm
<b>Scanning range</b>	10 m
<b>Protective field height</b>	1,200 mm
<b>Synchronization</b>	Optical synchronisation

#### Safety-related parameters

<b>Type</b>	Type 4 (IEC 61496-1)
<b>Safety integrity level</b>	SIL 3 (IEC 61508)
<b>Category</b>	Category 4 (EN ISO 13849)
<b>Performance level</b>	PL e (EN ISO 13849)
<b>PFH<sub>D</sub> (mean probability of a dangerous failure per hour)</b>	15 * 10 <sup>-9</sup> (EN ISO 13849) 43 * 10 <sup>-9</sup> (EN ISO 13849) 63 * 10 <sup>-9</sup> (EN ISO 13849)
<b>T<sub>M</sub> (mission time)</b>	20 years (EN ISO 13849)
<b>Safe state in the event of a fault</b>	At least one OSSD is in the OFF state.

#### Functions

	Functions	Delivery status
<b>Protective operation</b>	✓	
<b>Restart interlock</b>	✓	
<b>External device monitoring (EDM)</b>	✓	Deactivated
<b>Beam coding</b>	✓	Uncoded
<b>Configurable scanning range</b>	✓	0 m ... 2.5 m

	Functions	Delivery status
Fixed blanking	✓	Deactivated
Floating blanking	✓	Deactivated
Safe SICK device communication via EFI	✓	

#### Functions in combination with UE402

Bypass	✓
Operating mode switching	✓
PSDI mode	✓

#### Interfaces

<b>System connection</b>	Hirschmann male connector M26, 12-pin
Direction of cable connection	Straight
Conductor cross section	0.75 mm <sup>2</sup>
Permitted cable length	50 m <sup>1)</sup>
<b>Extension connection</b>	Hirschmann female connector M26, 12 pin
<b>Display elements</b>	7-segment display

<sup>1)</sup> Depending on load, power supply and wire cross-section. The technical specifications must be observed.

#### Electrical data

<b>Protection class</b>	III (IEC 61140)
<b>Supply voltage <math>V_S</math></b>	24 V DC (19.2 V ... 28.8 V) <sup>1)</sup>
<b>Residual ripple</b>	≤ 10 % <sup>2)</sup>

<sup>1)</sup> The external voltage supply must be capable of buffering brief mains voltage failures of 20 ms as specified in EN 60204-1. Suitable power supplies are available as accessories from SICK.

<sup>2)</sup> Within the limits of  $V_S$ .

#### Mechanical data

<b>Dimensions</b>	See dimensional drawing
<b>Housing cross-section</b>	48 mm x 40 mm
<b>Housing material</b>	Aluminum extruded profile
<b>Weight</b>	2,530 g

#### Ambient data

<b>Enclosure rating</b>	IP65 (EN 60529)
<b>Ambient operating temperature</b>	0 °C ... +55 °C
<b>Storage temperature</b>	-25 °C ... +70 °C
<b>Air humidity</b>	15 % ... 95 %, Non-condensing
<b>Vibration resistance</b>	5 g, 10 Hz ... 55 Hz (EN 60068-2-6)
<b>Shock resistance</b>	10 g, 16 ms (EN 60068-2-27)

#### Other information

<b>Wave length</b>	850 nm
--------------------	--------

#### Classifications

<b>ECLASS 5.0</b>	27272704
<b>ECLASS 5.1.4</b>	27272704

<b>ECLASS 6.0</b>	27272704
<b>ECLASS 6.2</b>	27272704
<b>ECLASS 7.0</b>	27272704
<b>ECLASS 8.0</b>	27272704
<b>ECLASS 8.1</b>	27272704
<b>ECLASS 9.0</b>	27272704
<b>ECLASS 10.0</b>	27272704
<b>ECLASS 11.0</b>	27272704
<b>ECLASS 12.0</b>	27272704
<b>ETIM 5.0</b>	EC002549
<b>ETIM 6.0</b>	EC002549
<b>ETIM 7.0</b>	EC002549
<b>ETIM 8.0</b>	EC002549
<b>UNSPSC 16.0901</b>	46171620

### Dimensional drawing (Dimensions in mm (inch))

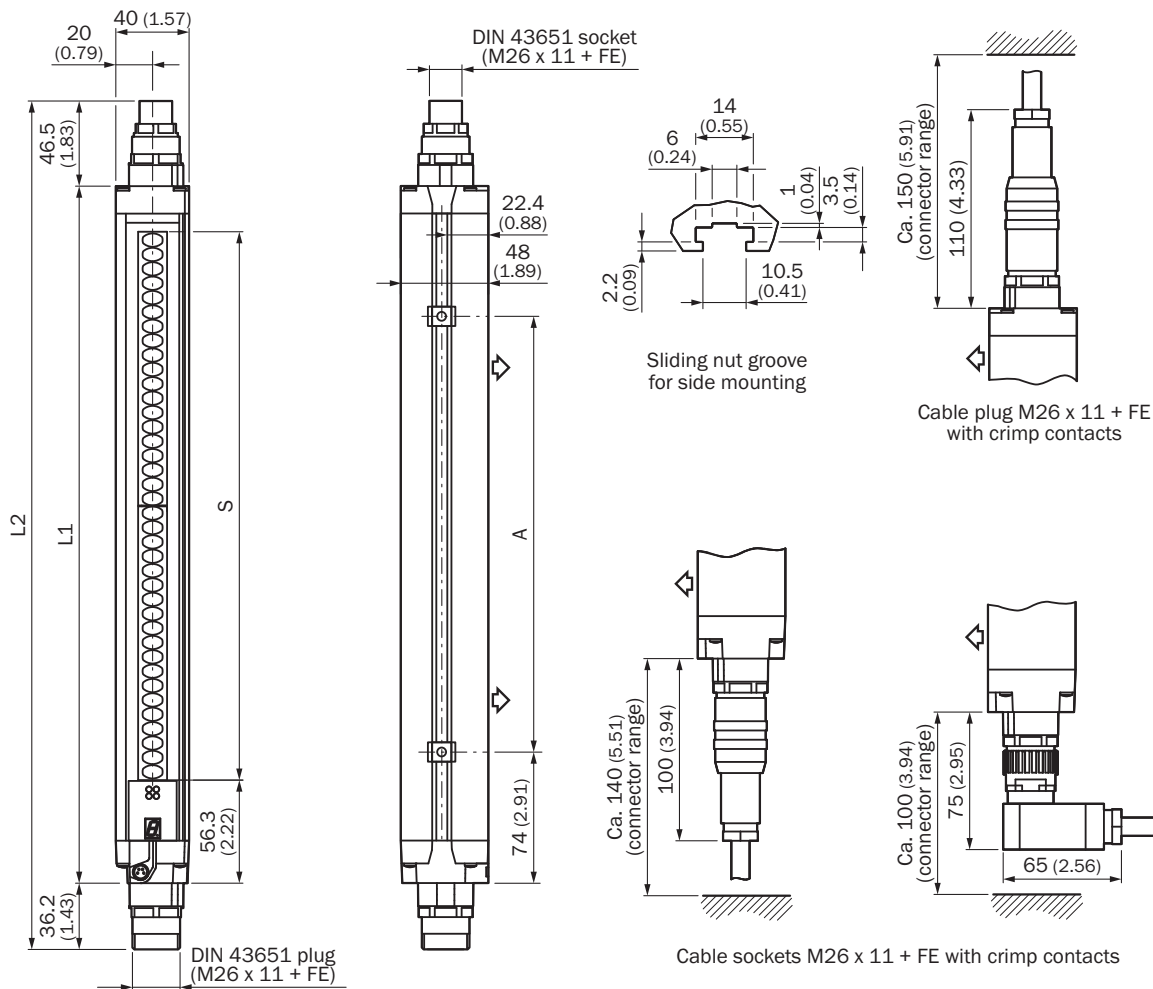

Illustration sender (receiver mirror image)

	L1	L2	A
300	381	464	224
450	532	614	374
600	682	765	524
750	833	915	674
900	984	1.066	824
1.050	1.134	1.216	974
1.200	1.283	1.366	1.124
1.350	1.435	1.517	1.274
1.500	1.586	1.669	1.424
1.650	1.736	1.818	1.574
1.800	1.887	1.969	1.724

Connection diagram

C4000 safety light curtain to UE10-30S safety relay



Task

Connection of a C4000 Standard/Advanced/Palletizer/Fusion safety light curtain to UE10-30S. Operating mode with restart interlock and external device monitoring.

Function

When the light path is clear and the UE10-30S is de-energized and functioning correctly, the yellow LED on the receiver and the H3 lamp flash. The system is ready to be switched on. The system is enabled by pressing S1 (button is pressed and released). The OSSD1 and OSSD2 outputs are live, and the UE10-30S is switched on. Upon the interruption of one of the light beams, the UE10-30S is deactivated by the OSSD1 and OSSD2 outputs.

### Possible faults

Cross-circuits and short-circuits of the OSSDs are detected and lead to the inhibited state (lock-out). The incorrect functioning of the UE10-30S will be detected, but will not result in the loss of the shutdown function. Jamming of the S1 button prevents the output circuit from enabling. H2 lamp is illuminated if there is contamination (adjustable parameter).

### Comments

<sup>1)</sup> Output circuits: These contacts are to be connected to the controller such that, with the output circuit open, the dangerous state is disabled. For categories 4 and 3, this integration must be dual-channel (x/y paths). Single-channel integration in the control (z path) is only possible with a single-channel control and taking the risk analysis into account.

<sup>2)</sup> PELV as required in EN 60204-1 / 6.4

The related operating instructions for the integrated devices must be observed.

### Recommended accessories

Other models and accessories → [www.sick.com/C4000\\_Advanced](http://www.sick.com/C4000_Advanced)

	Brief description	Type	Part no.
<b>Alignment aids</b>			
	Laser alignment aid for various sensors, laser class 2 (IEC 60825). Do not look into the beam!, 19 mm x 67.3 mm x 66.9 mm	AR60	1015741
	Adapter AR60 for housing cross-section 48 mm x 40 mm	AR60 adapter, 48x40	4032461
	Adapter AR60 for housing cross-section 48 mm x 40 mm in PU3H device column	AR60 adapter, 48x40, PU3H	4056731
<b>Optics cloths</b>			
	Cloth for cleaning optical surfaces	Lens cloth	4003353
<b>Mounting brackets and plates</b>			
	4 pieces, Mounting kit 1, mounting bracket, rigid, L-shaped, including fixing screws and washers	BEF-3WNGBAST4	7021352
<b>Terminal and alignment brackets</b>			
	4 pieces, Mounting kit 6, side bracket, rotatable, zinc diecast	BEF-1SHABAZN4	2019506
	4 pieces, Omega bracket, rotatable, fixable with only one screw, for mounting on the swivel mount	BEF-2SMMEAAL4	2044847
	4 pieces, Stainless steel bracket, rotatable, stainless steel 1.4350, stainless steel 1.4301	BEF-2SMMEAES4	2023708
	4 pieces, Mounting kit 2, rotatable, swivel mount, Polyamide PA6	BEF-2SMMEAKU4	2019659

	Brief description	Type	Part no.
Others			
	<ul style="list-style-type: none"> <li><b>Connection type head A:</b> Male connector, M8, 4-pin, straight</li> <li><b>Connection type head B:</b> Male connector, USB-A, straight</li> <li><b>Cable:</b> 2 m, 4-wire, PVC</li> <li><b>Description:</b> Unshielded, Configuration cable with integrated RS-232 transducer on USB for connecting a sensor configuration connection (M8, 4-pin) to the USB interface of a PC</li> </ul>	DSL-8U04G02M025KM1	6034574
	<ul style="list-style-type: none"> <li><b>Connection type head A:</b> Male connector, M8, 4-pin, straight</li> <li><b>Connection type head B:</b> Male connector, USB-A, straight</li> <li><b>Cable:</b> 10 m, 4-wire, PVC</li> <li><b>Description:</b> Unshielded, Configuration cable with integrated RS-232 transducer on USB for connecting a sensor configuration connection (M8, 4-pin) to the USB interface of a PC</li> </ul>	DSL-8U04G10M025KM1	6034575
	<ul style="list-style-type: none"> <li><b>Connection type head A:</b> Female connector, M26, 12-pin, straight</li> <li><b>Connection type head B:</b> Flying leads</li> <li><b>Signal type:</b> Sensor/actuator cable</li> <li><b>Cable:</b> 5 m, 12-wire, PVC</li> <li><b>Description:</b> Sensor/actuator cable, unshielded</li> <li><b>Connection systems:</b> Flying leads</li> </ul>	DOL-0612G05M075KM0	2022545
	<ul style="list-style-type: none"> <li><b>Connection type head A:</b> Female connector, M26, 12-pin, straight</li> <li><b>Connection type head B:</b> Flying leads</li> <li><b>Signal type:</b> Sensor/actuator cable</li> <li><b>Cable:</b> 10 m, 12-wire, PVC</li> <li><b>Description:</b> Sensor/actuator cable, unshielded</li> <li><b>Connection systems:</b> Flying leads</li> </ul>	DOL-0612G10M075KM0	2022547
	<ul style="list-style-type: none"> <li><b>Connection type head A:</b> Female connector, M26, 12-pin, straight</li> <li><b>Connection type head B:</b> Flying leads</li> <li><b>Signal type:</b> Sensor/actuator cable</li> <li><b>Cable:</b> 15 m, 12-wire, PVC</li> <li><b>Description:</b> Sensor/actuator cable, unshielded</li> <li><b>Connection systems:</b> Flying leads</li> </ul>	DOL-0612G15M075KM0	2022548
	<ul style="list-style-type: none"> <li><b>Connection type head A:</b> Female connector, M26, 12-pin, straight</li> <li><b>Connection type head B:</b> Flying leads</li> <li><b>Signal type:</b> Sensor/actuator cable</li> <li><b>Cable:</b> 20 m, 12-wire, PVC</li> <li><b>Description:</b> Sensor/actuator cable, unshielded</li> <li><b>Connection systems:</b> Flying leads</li> </ul>	DOL-0612G20M075KM0	2022549
	<ul style="list-style-type: none"> <li><b>Connection type head A:</b> Female connector, M26, 12-pin, straight</li> <li><b>Connection type head B:</b> Flying leads</li> <li><b>Cable:</b> 5 m, PVC</li> <li><b>Description:</b> Unshielded</li> <li><b>Connection systems:</b> Flying leads</li> <li><b>Note:</b> Without EFI: Pin 9 and 10 not connected</li> </ul>	DOL-0610G05M075KM1	2046888
	<ul style="list-style-type: none"> <li><b>Connection type head A:</b> Female connector, M26, 12-pin, straight</li> <li><b>Connection type head B:</b> Flying leads</li> <li><b>Cable:</b> 10 m, PVC</li> <li><b>Description:</b> Unshielded</li> <li><b>Connection systems:</b> Flying leads</li> <li><b>Note:</b> Without EFI: Pin 9 and 10 not connected</li> </ul>	DOL-0610G10M075KM1	2046889
	<ul style="list-style-type: none"> <li><b>Connection type head A:</b> Female connector, M26, 12-pin, straight, A-coded</li> <li><b>Description:</b> Unshielded</li> <li><b>Connection systems:</b> Crimp contacts</li> <li><b>Permitted cross-section:</b> 0.5 mm<sup>2</sup> ... 1.5 mm<sup>2</sup></li> <li><b>Note:</b> 12 crimping contacts enclosed</li> </ul>	DOS-0612G000GA3KM0	6020757
	<ul style="list-style-type: none"> <li><b>Connection type head A:</b> Female connector, M26, 12-pin, angled, A-coded</li> <li><b>Description:</b> Unshielded</li> <li><b>Connection systems:</b> Crimp contacts</li> <li><b>Permitted cross-section:</b> 0.5 mm<sup>2</sup> ... 1.5 mm<sup>2</sup></li> <li><b>Note:</b> 12 crimping contacts enclosed</li> </ul>	DOS-0612W000GA3KM0	6020758

	Brief description	Type	Part no.
	<ul style="list-style-type: none"> <li>• <b>Connection type head A:</b> Male connector, M26, 12-pin, straight, A-coded</li> <li>• <b>Description:</b> Unshielded</li> <li>• <b>Connection systems:</b> Crimp contacts</li> <li>• <b>Permitted cross-section:</b> 0.5 mm<sup>2</sup> ... 1.5 mm<sup>2</sup></li> <li>• <b>Note:</b> 12 crimping contacts enclosed</li> </ul>	STE-0612G000GA3KMO	6021191
	<ul style="list-style-type: none"> <li>• <b>Connection type head A:</b> Male connector, M26, 12-pin, angled, A-coded</li> <li>• <b>Description:</b> Unshielded</li> <li>• <b>Connection systems:</b> Crimp contacts</li> <li>• <b>Permitted cross-section:</b> 0.5 mm<sup>2</sup> ... 1.5 mm<sup>2</sup></li> <li>• <b>Note:</b> 12 crimping contacts enclosed</li> </ul>	STE-0612W000GA3KMO	6021192
Switching amplifiers			
	<ul style="list-style-type: none"> <li>• <b>Applications:</b> Functionality upgrade</li> <li>• <b>Compatible sensor types:</b> C4000 safety light curtains</li> <li>• <b>Description:</b> Upgrades the C4000 Standard, Advanced, Palletizer, Entry/Exit, and Fusion to include the functions defined in the technical specifications, e.g., bypass, operating mode switching, and PSDI in the case of C4000 Standard, Advanced.</li> </ul>	UE402	1023577



## SICK AT A GLANCE

SICK is one of the leading manufacturers of intelligent sensors and sensor solutions for industrial applications. A unique range of products and services creates the perfect basis for controlling processes securely and efficiently, protecting individuals from accidents and preventing damage to the environment.

We have extensive experience in a wide range of industries and understand their processes and requirements. With intelligent sensors, we can deliver exactly what our customers need. In application centers in Europe, Asia and North America, system solutions are tested and optimized in accordance with customer specifications. All this makes us a reliable supplier and development partner.

Comprehensive services complete our offering: SICK LifeTime Services provide support throughout the machine life cycle and ensure safety and productivity.

For us, that is “Sensor Intelligence.”

## WORLDWIDE PRESENCE:

Contacts and other locations –[www.sick.com](http://www.sick.com)