



# C4C-SG06010A10000

deTec

SAFETY LIGHT CURTAINS

**SICK**  
Sensor Intelligence.



### Ordering information

deTec4 Core HG

Resolution	Scanning range	Protective field height	System part	Type	Part no.
14 mm	10 m	600 mm	Sender	C4C-SG06010A10000	1220367

Other models and accessories → [www.sick.com/deTec](http://www.sick.com/deTec)

Illustration may differ



### Detailed technical data

#### Features

<b>Sub product family</b>	deTec4 Core HG
<b>Application</b>	Areas where coolants, lubricants and cleaning agents are used
<b>System part</b>	Sender
<b>Compatible receiver</b>	1220378
<b>Resolution</b>	14 mm
<b>Scanning range</b>	10 m
<b>Protective field height</b>	600 mm
<b>No blind zones</b>	Yes
<b>Synchronization</b>	Optical synchronisation
<b>Items supplied</b>	Sender

#### Safety-related parameters

<b>Type</b>	Type 4 (IEC 61496-1)
<b>Safety integrity level</b>	SIL 3 (IEC 61508)
<b>Category</b>	Category 4 (ISO 13849-1)
<b>Performance level</b>	PL e (ISO 13849-1)
<b>PFH<sub>D</sub> (mean probability of a dangerous failure per hour)</b>	$3.7 \times 10^{-9}$
<b>T<sub>M</sub> (mission time)</b>	20 years (ISO 13849-1)
<b>Safe state in the event of a fault</b>	At least one OSSD is in the OFF state.

#### Functions

<b>Protective operation</b>	✓
<b>Automatic calibration of the protective field width</b>	✓

#### Interfaces

<b>System connection</b>	Male connector M12, 5-pin
--------------------------	---------------------------

	Length of cable	150 mm
	Cable diameter	4.3 mm
<b>Cable bend radius</b>	Stationary position	> 12 x cable diameter
	Flexible use	> 15 x cable diameter
<b>Display elements</b>		LEDs

## Electrical data

<b>Protection class</b>	III (IEC 61140)
<b>Supply voltage <math>V_s</math></b>	24 V DC (19.2 V ... 28.8 V)
<b>Ripple</b>	≤ 10 %
<b>Power consumption typical</b>	1.2 W (DC)

## Mechanical data

<b>Dimensions</b>	See dimensional drawing
<b>Housing material</b>	Aluminum extruded profile
<b>Front screen material</b>	Chemically prestressed float glass

## Ambient data

<b>Enclosure rating</b>	IP65 (IEC 60529) IP67 (IEC 60529)
<b>Ambient operating temperature</b>	-30 °C ... +55 °C
<b>Storage temperature</b>	-30 °C ... +70 °C
<b>Air humidity</b>	15 % ... 95 %, Non-condensing
<b>Vibration resistance</b>	5 g, 10 Hz ... 55 Hz (IEC 60068-2-6)
<b>Shock resistance</b>	10 g, 16 ms (IEC 60068-2-27)

## Other information

<b>Wave length</b>	850 nm
<b>Type of light</b>	Near-infrared (NIR), invisible

## Classifications

<b>ECLASS 5.0</b>	27272704
<b>ECLASS 5.1.4</b>	27272704
<b>ECLASS 6.0</b>	27272704
<b>ECLASS 6.2</b>	27272704
<b>ECLASS 7.0</b>	27272704
<b>ECLASS 8.0</b>	27272704
<b>ECLASS 8.1</b>	27272704
<b>ECLASS 9.0</b>	27272704
<b>ECLASS 10.0</b>	27272704
<b>ECLASS 11.0</b>	27272704
<b>ECLASS 12.0</b>	27272704
<b>ETIM 5.0</b>	EC002549
<b>ETIM 6.0</b>	EC002549
<b>ETIM 7.0</b>	EC002549

<b>ETIM 8.0</b>	EC002549
<b>UNSPSC 16.0901</b>	46171620

### Dimensional drawing (Dimensions in mm (inch))

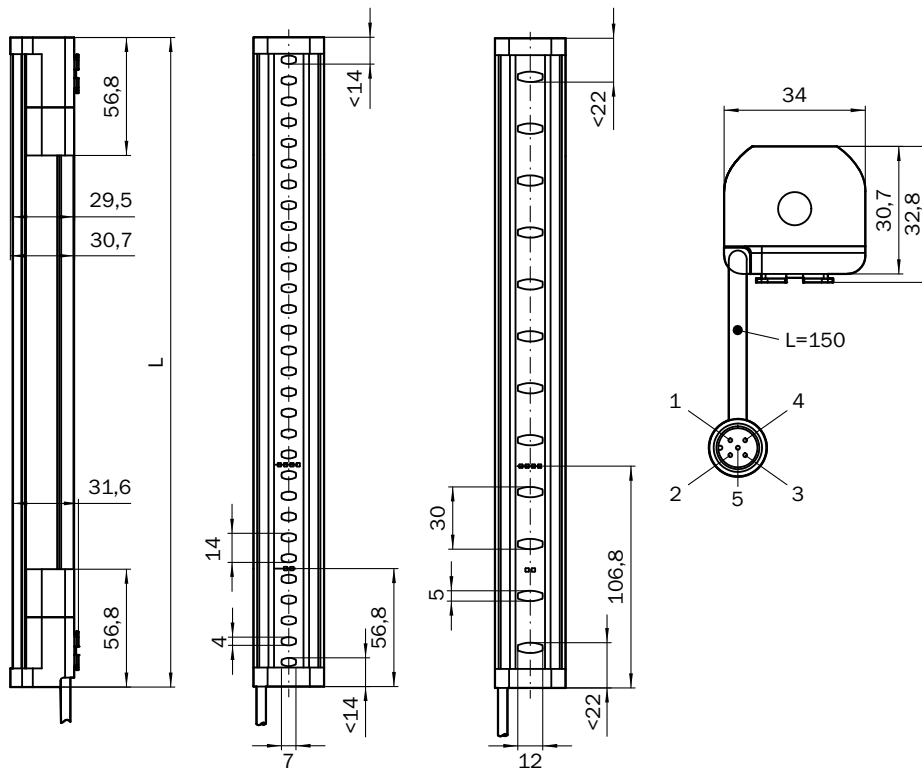

Protective field height	L
300 (11.81)	313 (12.32)
450 (17.72)	463 (18.23)
600 (23.62)	613 (24.13)
750 (29.53)	763 (30.04)
900 (35.43)	913 (35.94)
1,050 (41.34)	1,063 (41.85)
1,200 (47.24)	1,213 (47.76)
1,350 (53.15)	1,362 (53.62)
1,500 (59.06)	1,512 (59.53)
1,650 (64.96)	1,662 (65.43)
1,800 (70.87)	1,812 (71.34)
1,950 (76.77)	1,962 (77.24)
2,100 (82.68)	2,112 (83.15)

## Recommended accessories

Other models and accessories → [www.sick.com/deTec](http://www.sick.com/deTec)

	Brief description	Type	Part no.
Terminal and alignment brackets			
	4 pieces, FlexFix bracket for 2 devices (e.g. sender and receiver), can be aligned $\pm 15^\circ$ , including M5 screw, plastic	BEF-1SHABPKU4	2066614
	4 pieces, QuickFix bracket for 2 devices (e.g. sender and receiver), plastic	BEF-3SHABPKU4	2098710
Others			
	<ul style="list-style-type: none"> <li><b>Connection type head A:</b> Female connector, M12, 5-pin, A-coded</li> <li><b>Connection type head B:</b> Male connector, M12, 5-pin, A-coded</li> <li><b>Connection type head C:</b> Female connector, M12, 5-pin, A-coded</li> <li><b>Description:</b> T-piece for simultaneous connection to sender and receiver, splits the cable from the control cabinet to the sender and receiver</li> <li><b>Note:</b> 5-pin</li> </ul>	DSC-1205T000025KM0	6030664
	<ul style="list-style-type: none"> <li><b>Connection type head A:</b> Female connector, M12, 5-pin, straight, A-coded</li> <li><b>Connection type head B:</b> Male connector, M12, 5-pin, straight, A-coded</li> <li><b>Signal type:</b> Sensor/actuator cable</li> <li><b>Cable:</b> 2 m, 5-wire, PUR, halogen-free</li> <li><b>Description:</b> Sensor/actuator cable, unshielded</li> <li><b>Application:</b> Zones with oils and lubricants, Drag chain operation, Robot</li> </ul>	YF2A15-020UB5M2A15	2096009
	<ul style="list-style-type: none"> <li><b>Connection type head A:</b> Female connector, M12, 5-pin, straight, A-coded</li> <li><b>Connection type head B:</b> Male connector, M12, 5-pin, straight, A-coded</li> <li><b>Signal type:</b> Sensor/actuator cable</li> <li><b>Cable:</b> 5 m, 5-wire, PUR, halogen-free</li> <li><b>Description:</b> Sensor/actuator cable, unshielded</li> <li><b>Application:</b> Zones with oils and lubricants, Drag chain operation, Robot</li> </ul>	YF2A15-050UB5M2A15	2096010
	<ul style="list-style-type: none"> <li><b>Connection type head A:</b> Female connector, M12, 5-pin, straight, A-coded</li> <li><b>Connection type head B:</b> Male connector, M12, 5-pin, straight, A-coded</li> <li><b>Signal type:</b> Sensor/actuator cable</li> <li><b>Cable:</b> 10 m, 5-wire, PUR, halogen-free</li> <li><b>Description:</b> Sensor/actuator cable, unshielded</li> <li><b>Application:</b> Zones with oils and lubricants, Drag chain operation, Robot</li> </ul>	YF2A15-100UB5M2A15	2096011
	<ul style="list-style-type: none"> <li><b>Connection type head A:</b> Female connector, M12, 5-pin, straight, A-coded</li> <li><b>Connection type head B:</b> Flying leads</li> <li><b>Signal type:</b> Sensor/actuator cable</li> <li><b>Cable:</b> 2 m, 5-wire, PUR, halogen-free</li> <li><b>Description:</b> Sensor/actuator cable, unshielded</li> <li><b>Application:</b> Zones with oils and lubricants, Drag chain operation, Robot</li> </ul>	YF2A15-020UB5XLEAX	2095617
	<ul style="list-style-type: none"> <li><b>Connection type head A:</b> Female connector, M12, 5-pin, straight, A-coded</li> <li><b>Connection type head B:</b> Flying leads</li> <li><b>Signal type:</b> Sensor/actuator cable</li> <li><b>Cable:</b> 5 m, 5-wire, PUR, halogen-free</li> <li><b>Description:</b> Sensor/actuator cable, unshielded</li> <li><b>Application:</b> Zones with oils and lubricants, Drag chain operation, Robot</li> </ul>	YF2A15-050UB5XLEAX	2095618
	<ul style="list-style-type: none"> <li><b>Connection type head A:</b> Female connector, M12, 5-pin, straight, A-coded</li> <li><b>Connection type head B:</b> Flying leads</li> <li><b>Signal type:</b> Sensor/actuator cable</li> <li><b>Cable:</b> 10 m, 5-wire, PUR, halogen-free</li> <li><b>Description:</b> Sensor/actuator cable, unshielded</li> <li><b>Application:</b> Zones with oils and lubricants, Drag chain operation, Robot</li> </ul>	YF2A15-100UB5XLEAX	2095619

	Brief description	Type	Part no.
Safety switching amplifier			
	<ul style="list-style-type: none"> <li>• <b>Applications:</b> Evaluation unit</li> <li>• <b>Compatible sensor types:</b> Safety sensors with OSSDs</li> <li>• <b>Connection type:</b> Front connector with spring terminals</li> <li>• <b>Restart interlock:</b> yes</li> <li>• <b>External device monitoring (EDM):</b> Integrated</li> <li>• <b>Outputs:</b> 2 enabling current paths (safe), 2 application diagnostic outputs (not safe), 1 test pulse output (not safe)</li> <li>• <b>Housing width:</b> 18 mm</li> </ul>	RLY3-OSSD200	1085344
	<ul style="list-style-type: none"> <li>• <b>Applications:</b> Evaluation unit</li> <li>• <b>Compatible sensor types:</b> Safety sensors with OSSDs</li> <li>• <b>Connection type:</b> Front connector with spring terminals</li> <li>• <b>Restart interlock:</b> yes</li> <li>• <b>External device monitoring (EDM):</b> Integrated</li> <li>• <b>Outputs:</b> 3 enabling current paths (safe), 2 application diagnostic outputs (not safe), 1 test pulse output (not safe)</li> <li>• <b>Housing width:</b> 18 mm</li> </ul>	RLY3-OSSD300	1099969

## SICK AT A GLANCE

SICK is one of the leading manufacturers of intelligent sensors and sensor solutions for industrial applications. A unique range of products and services creates the perfect basis for controlling processes securely and efficiently, protecting individuals from accidents and preventing damage to the environment.

We have extensive experience in a wide range of industries and understand their processes and requirements. With intelligent sensors, we can deliver exactly what our customers need. In application centers in Europe, Asia and North America, system solutions are tested and optimized in accordance with customer specifications. All this makes us a reliable supplier and development partner.

Comprehensive services complete our offering: SICK LifeTime Services provide support throughout the machine life cycle and ensure safety and productivity.

For us, that is “Sensor Intelligence.”

## WORLDWIDE PRESENCE:

Contacts and other locations –[www.sick.com](http://www.sick.com)