

CKS36-AFB80006

CKS36

MOTOR FEEDBACK SYSTEMS ROTARY INCREMENTAL WITH COMMUTATION

SICK
Sensor Intelligence.

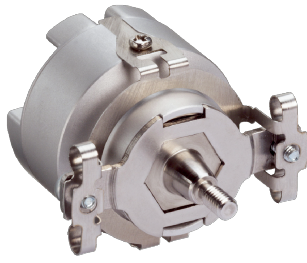

Illustration may differ

Ordering information

Type	Part no.
CKS36-AFB80006	1037539

Other models and accessories → www.sick.com/CKS36

Detailed technical data

Performance

Number of the absolute ascertainable revolutions	1
Number of lines per revolution	2,048
Measuring step	90° /number of lines
Commutation signals	6 pole pairs (according to EIA 422)
Zero pulse width	90°
Reference signal, number	1
Reference signal, position	90° or 180° configurable, electric, gated with A and B
Measuring step deviation	± 0.035°
Operating speed	≤ 12,000 min ⁻¹ , working speed up to which the output signals are correct

Interfaces

Communication interface	Incremental
--------------------------------	-------------

Electrical data

Connection type	Male connector, 14-pin, axial
Supply voltage	4.5 V DC ... 5.5 V DC
Current consumption	< 60 mA ¹⁾
Maximum output frequency	≤ 400 kHz
MTTF: mean time to dangerous failure	275 years (EN ISO 13849) ²⁾

¹⁾ Without load.

²⁾ This product is a standard product and does not constitute a safety component as defined in the Machinery Directive. Calculation based on nominal load of components, average ambient temperature 60°C, frequency of use 8760 h/a. All electronic failures are considered hazardous. For more information, see document no. 8015532.

Mechanical data

Shaft version	Tapered shaft
Flange type / stator coupling	Spring mounting plate
Dimensions	See dimensional drawing
Weight	+ 0.065 kg
Moment of inertia of the rotor	4.5 gcm ²
Operating speed	12,000 min ⁻¹ ¹⁾

¹⁾ Allow for self-heating of 1.1 K per 1,000 rpm when designing the operating temperature range.

Angular acceleration	≤ 500,000 rad/s ²
Operating torque	0.2 Ncm
Start up torque	+ 0.3 Ncm
Permissible movement of the drive element, static	± 0.5 mm radial ± 0.2 mm axial
Permissible movement of the drive element, dynamic	± 0.1 mm radial ± 0.1 mm axial
Life of ball bearings	3.6 x 10 ⁹ revolutions

¹⁾ Allow for self-heating of 1.1 K per 1,000 rpm when designing the operating temperature range.

Ambient data

Operating temperature range	-20 °C ... +110 °C
Storage temperature range	-40 °C ... +125 °C, without package
Relative humidity/condensation	90 %, Condensation not permitted
Resistance to shocks	100 g, 6 ms (according to EN 60068-2-27)
Frequency range of resistance to vibrations	50 g, 10 Hz ... 2,000 Hz (EN 60068-2-6)
EMC	According to EN 61000-6-2 and EN 61000-6-3 ¹⁾
Enclosure rating	IP50, with mating connector inserted and closed cover (IEC 60529)

¹⁾ The EMC according to the standards quoted is achieved when the motor feedback system is mounted in an electrically conductive housing, which is connected to the central earthing point of the motor controller via a cable screen. The GND-(0 V) connection of the supply voltage is also grounded here. If other shielding concepts are used, users must perform their own tests.

Classifications

eCI@ss 5.0	27270501
eCI@ss 5.1.4	27270501
eCI@ss 6.0	27270590
eCI@ss 6.2	27270590
eCI@ss 7.0	27270501
eCI@ss 8.0	27270501
eCI@ss 8.1	27270501
eCI@ss 9.0	27270501
eCI@ss 10.0	27273805
eCI@ss 11.0	27273901
eCI@ss 12.0	27273901
ETIM 5.0	EC001486
ETIM 6.0	EC001486
ETIM 7.0	EC001486
ETIM 8.0	EC001486
UNSPSC 16.0901	41112113

Dimensional drawing (Dimensions in mm (inch))

General tolerances according to DIN ISO 2768-mk

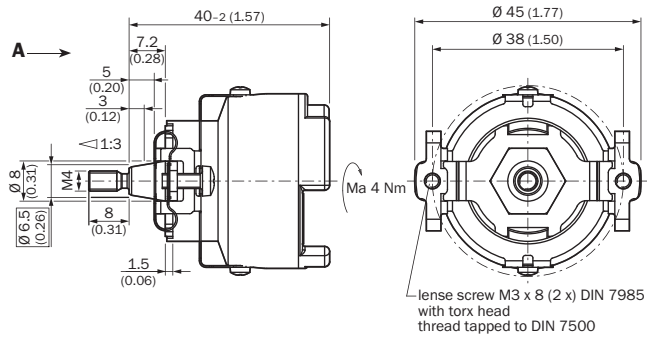

Attachment specifications

General tolerances according to DIN ISO 2768-mk

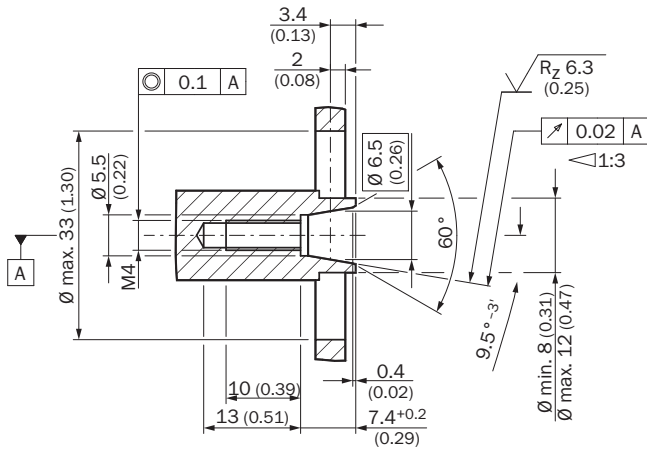

All dimensions in mm (inch)

PIN assignment

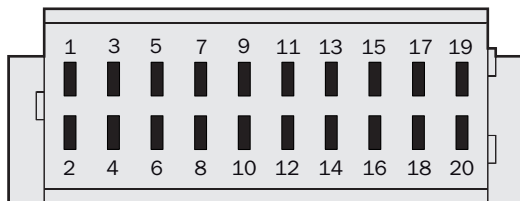

Diagrams

At constant speed, looking at the input shaft, and clockwise rotation

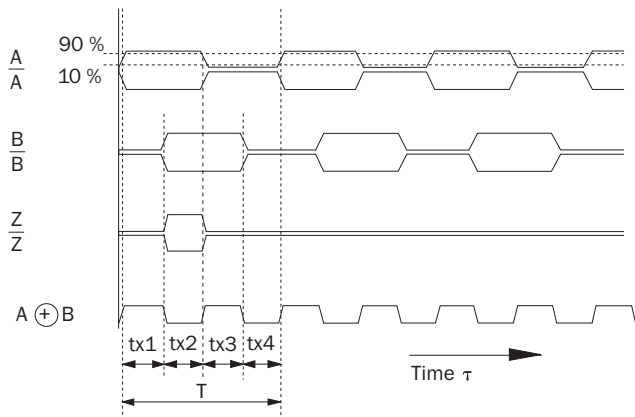

At constant rotational speed with regard to the input shaft and rotation in clockwise direction.

By connecting the two signals A and B, an output signal arises whose period durations $tx1 \dots tx4$ have varying lengths.

The differences are determined:

- by the pulse/pause ratio tolerance of the individual channels
- by the tolerance in the 90° phase shift between A and B
- by the frequency

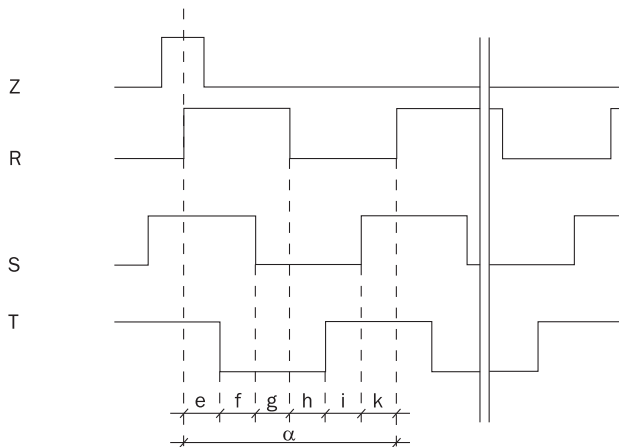

The times $tx1 \dots tx4$ ideally have to amount to 1/4 of the particular period duration T . The typical output frequency of the encoder is defined so that the max. time tx is smaller than $1.5 \times T/4$.



Recommended accessories

Other models and accessories → www.sick.com/CKS36

	Brief description	Type	Part no.
Programming and configuration tools			
	SVip® LAN programming tool for all motor feedback systems	PGT-11-S LAN	1057324

	Brief description	Type	Part no.
Other mounting accessories			
	BEF-MW-SKX36	BEF-MW-SKX36	2031079
Plug connectors and cables			
	DOL-1J14-G0M2XB7	DOL-1J14-G0M2XB7	6030948
	Head A: female connector, JST, 8-pin, straight Head B: male connector, M23, 17-pin, straight Cable: Incremental, unshielded, 1 m	DSL-2317-G01MJB7	2071332
	Head A: female connector, terminal box, 8-pin, straight Head B: male connector, M23, 17-pin, straight Cable: Incremental, unshielded, 1 m	DSL-2317-G01MJC7	2071331

SICK AT A GLANCE

SICK is one of the leading manufacturers of intelligent sensors and sensor solutions for industrial applications. A unique range of products and services creates the perfect basis for controlling processes securely and efficiently, protecting individuals from accidents and preventing damage to the environment.

We have extensive experience in a wide range of industries and understand their processes and requirements. With intelligent sensors, we can deliver exactly what our customers need. In application centers in Europe, Asia and North America, system solutions are tested and optimized in accordance with customer specifications. All this makes us a reliable supplier and development partner.

Comprehensive services complete our offering: SICK LifeTime Services provide support throughout the machine life cycle and ensure safety and productivity.

For us, that is “Sensor Intelligence.”

WORLDWIDE PRESENCE:

Contacts and other locations –www.sick.com