



CLV615-D2410F0

CLV61x

FIXED MOUNT BARCODE SCANNERS

SICK
Sensor Intelligence.

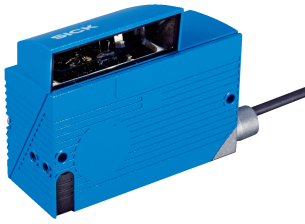

Ordering information

Type	Part no.
CLV615-D2410F0	1078175

Other models and accessories → www.sick.com/CLV61x



Detailed technical data

Features

Version	Long Range
Connection type	Cable
Reading field	Side (105°)
Sensor type	Line scanner
Optical focus	Fixed focus
Light source	Light spot, laser, Visible, Red, 655 nm
Laser class	2, complies with 21 CFR 1040.10 except for the conformance according to "Laser Notice No. 56" from May 8, 2019 (EN 60825-1:2014+A11:2021, IEC 60825-1:2014)
Aperture angle	≤ 50°
Reading distance	25 mm ... 330 mm ¹⁾
Scanning frequency	400 Hz ... 1,000 Hz
Code resolution	0.35 mm ... 0.5 mm
Heating	✓
Cold storage applications	✓

¹⁾ For details see reading field diagram.

Mechanics/electronics

Connection type	1 x "POWER" connection, 4-pin M12 plug (0.9 m), A-coded 1 x "PROFINET P1" connection, 4-pin M12 female connector, D-coded 1 x "PROFINET P2" connection, 4-pin M12 socket, D-coded 1 x Micro USB female connector, type B
Supply voltage	18 V DC ... 30 V DC
Power consumption	15 W
Housing material	Aluminum die cast
Housing color	Light blue (RAL 5012)
Window material	Glass
Enclosure rating	IP65 (DIN 40 050)

¹⁾ At 25 °C.

Protection class	III (VDE 0106/IEC 1010-1)
Weight	345.8 g
Dimensions (L x W x H)	80 mm x 96 mm x 38 mm
MTBF	100,000 h
MTTF	40,000 h (Laser diode) ¹⁾

¹⁾ At 25 °C.

Performance

Readable code structures	1D codes
Bar code types	All current code types, Code 39, Code 128, Code 93, Codabar, UPC / GTIN / EAN, Interleaved 2 of 5, Pharmacode
Code printing process	Label (printed codes)
Print ratio	2:1 ... 3:1
No. of codes per scan	1 ... 10 (Standard decoder) 1 ... 6 (SMART620)
No. of codes per reading interval	1 ... 50 (auto-discriminating)
No. of characters per reading interval	1,500
No. of multiple readings	1 ... 99

Interfaces

PROFINET	✓
Function	PROFINET Single Port, PROFINET Dual Port
Data transmission rate	2-port Ethernet in accordance with IEEE 802.3 (baud rate 100 MBit/s, full-duplex transmission, 2-port switch, auto-negotiation, auto-crossover). Maximum data length is limited by the mode of communication (fragmentation protocol) to 4,000 bytes.
USB	✓
Function	Service interface
Digital inputs	1 (via PROFINET Ctrl bits)
Digital outputs	4 (via PROFINET Ctrl bits)
Reading pulse	Non-powered, auto pulse, Fieldbus input, command
Optical indicators	5 LEDs
Configuration software	SOPAS ET

Ambient data

Electromagnetic compatibility (EMC)	EN 61000-6-4 (2007-01) + A1 (2011) / EN 61000-6-2:2005-08
Vibration resistance	EN 60068-2-6:2008-02
Shock resistance	EN 60068-2-27:2009-05
Ambient operating temperature	-35 °C ... +40 °C
Storage temperature	-20 °C ... +70 °C
Permissible relative humidity	90 %, Non-condensing
Ambient light immunity	2,000 lx, on barcode
Bar code print contrast (PCS)	≥ 60 %

Classifications

ECLASS 5.0	27280102
ECLASS 5.1.4	27280102

ECLASS 6.0	27280102
ECLASS 6.2	27280102
ECLASS 7.0	27280102
ECLASS 8.0	27280102
ECLASS 8.1	27280102
ECLASS 9.0	27280102
ECLASS 10.0	27280102
ECLASS 11.0	27280102
ECLASS 12.0	27280102
ETIM 5.0	EC002550
ETIM 6.0	EC002550
ETIM 7.0	EC002550
ETIM 8.0	EC002550
UNSPSC 16.0901	43211701

Dimensional drawing (Dimensions in mm (inch))

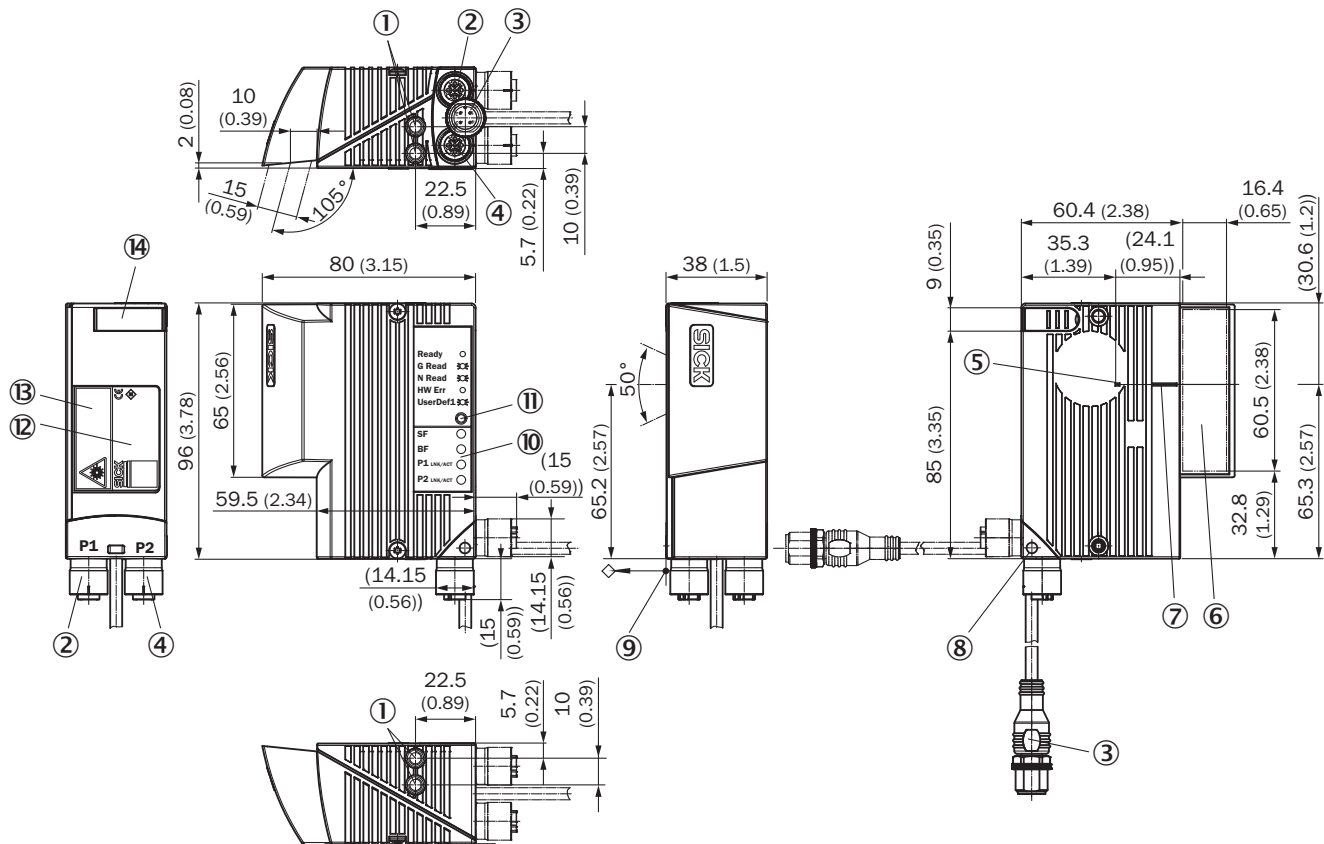





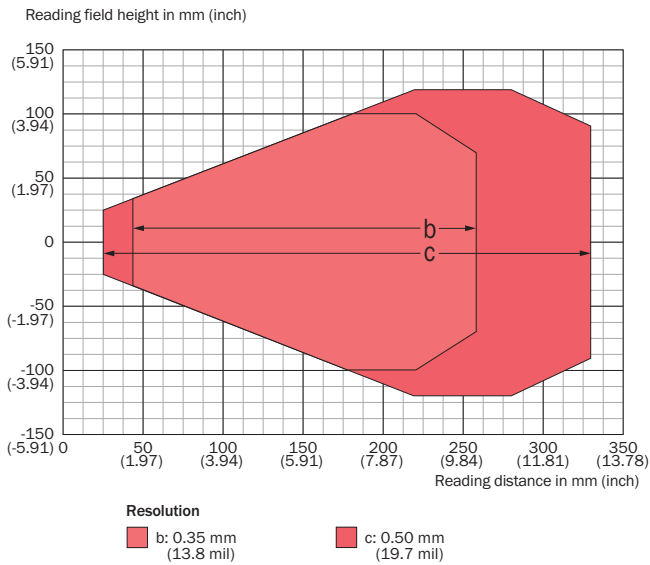

- ① Blind hole thread M5, 5 mm deep (2 x), for mounting
- ② P1 (Port 1) connection, 4-pin M12 female connector, D-coded
- ③ Acble (0.9 m) with POWER connection, 4-pin M12 male connector, A-coded
- ④ P2 (Port 2) connection, 4-pin M12 female connector, D-coded
- ⑤ Internal impact point: rotation point of the variable direction laser beam
- ⑥ Reading window, side orientation
- ⑦ Central position of the deflected laser beam in the V-shaped aperture angle
- ⑧ Swivel connector unit (max 180° rotation angle from end position to end position)
- ⑨ Reference point for reading distance (from housing edge to object)
- ⑩ LED (4 x), status indicator
- ⑪ RGB-LED (1 x), status display with signal color allocation for events
- ⑫ Type label
- ⑬ Laser warning label
- ⑭ Cover for USB port, 4-pin female connector, Micro B type



Reading field diagram

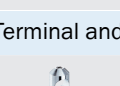

Recommended accessories

Other models and accessories → www.sick.com/CLV61x

	Brief description	Type	Part no.
Mounting brackets and plates			
	Hanger-shaped mounting bracket, thermally isolated for use with heating devices, mounting hardware included	Mounting bracket	2050705
	Hanger-shaped mounting bracket, mounting hardware included	Mounting bracket	2042800
	Mounting bracket (simple bracket), mounting hardware included	Mounting bracket	2020410
Terminal and alignment brackets			
	Rod clamp for outer diameter of 12 ... 20 mm, thermally isolated for use with heating devices, mounting hardware included	Rod clamp	2058082
Others			
	<ul style="list-style-type: none"> • Connection type head A: Male connector, Micro-B, 4-pin, straight • Connection type head B: Male connector, USB-A, 4-pin, straight • Signal type: USB 2.0 • Cable: 2 m, 4-wire • Description: USB 2.0, unshielded 	USB cable	6036106
	<ul style="list-style-type: none"> • Connection type head A: Flying leads • Connection type head B: Flying leads • Signal type: Power • Items supplied: By the meter • Cable: 2-wire, Vulcanized Rubber • Description: Power, unshielded, Black Actuator Sensor Interface flat cable for looping in the power supply to 4Dpro Ethernet sensors • Note: For use with connection clip 6022472 	Actuator Sensor Interface, LTGE-MW	6022463

	Brief description	Type	Part no.
	<ul style="list-style-type: none"> • Connection type head A: Female connector, M12, A-coded • Signal type: Power • Description: Power, AS-i clip for connection on black Actuator Sensor Interface flat cable 	Actuator Sensor Interface, M12	6022472
	<ul style="list-style-type: none"> • Connection type head A: Female connector, M12, 4-pin, straight, A-coded • Connection type head B: Male connector, M12, 4-pin, straight, A-coded • Signal type: Power • Cable: 2 m, PUR • Description: Power, silicone-free, free of paint wetting impairment substances, shielded • Note: With fuse (1A) and green LED in the male connector., For connecting a CLV61x Dual Port sensor to a connection chip (part no. 6022472) and flat cable (part no. 6022463) 	YX2A24-020UA4F2A24	6060279
	<ul style="list-style-type: none"> • Connection type head A: Flying leads • Connection type head B: Flying leads • Signal type: Power • Items supplied: By the meter • Cable: 2-wire, PUR • Description: Power, Silicone-free, for dynamic applications, unshielded, Black Actuator Sensor Interface flat cable for looping in the power supply to 4Dpro Ethernet sensors • Note: For use with connection clip 6022472 	Actuator Sensor Interface, LTGE-MW	6061897

Recommended services

Additional services → www.sick.com/CLV61x

	Type	Part no.
Performance check		
<ul style="list-style-type: none"> • Product area: Fixed mount barcode scanners • Range of services: Inspection of defined functions, e.g., reading performance • Duration: Additional work will be invoiced separately 	Performance check CLV	1682028
Commissioning		
<ul style="list-style-type: none"> • Product area: Fixed mount barcode scanners • Range of services: Inspection of connection, fine adjustment, optimization of parameters of SICK product as well as tests, Setup of previously defined functions of reading configuration, code configuration, data processing and network, interfaces or inputs and outputs • Duration: Additional work will be invoiced separately 	Commissioning CLV61x ... CLV64x	1681925
Extended warranty		
<ul style="list-style-type: none"> • Product area: Machine vision, LiDAR sensors, safety camera sensors, Safety laser scanners, Safety radar sensors, Radar sensors, Fixed mount barcode scanners, Image-based code readers, RFID, Mobile handheld scanners • Range of services: The services correspond to the scope of the statutory manufacturer warranty (SICK general terms of delivery). • Duration: Five-year warranty from delivery date. 	Extended warranty for a total of five years from delivery date	1680671

SICK AT A GLANCE

SICK is one of the leading manufacturers of intelligent sensors and sensor solutions for industrial applications. A unique range of products and services creates the perfect basis for controlling processes securely and efficiently, protecting individuals from accidents and preventing damage to the environment.

We have extensive experience in a wide range of industries and understand their processes and requirements. With intelligent sensors, we can deliver exactly what our customers need. In application centers in Europe, Asia and North America, system solutions are tested and optimized in accordance with customer specifications. All this makes us a reliable supplier and development partner.

Comprehensive services complete our offering: SICK LifeTime Services provide support throughout the machine life cycle and ensure safety and productivity.

For us, that is “Sensor Intelligence.”

WORLDWIDE PRESENCE:

Contacts and other locations –www.sick.com