



CLV640-6000

CLV64x

FIXED MOUNT BARCODE SCANNERS

SICK
Sensor Intelligence.



Ordering information

Type	Part no.
CLV640-6000	1042022

Other models and accessories → www.sick.com/CLV64x



Detailed technical data

Features

Version	Standard Density
Connection type	Cable
Reading field	Oscillating mirror
Sensor type	Oscillating mirror
Optical focus	Dynamic focus control
Light source	Light spot, laser, Visible, Red, 655 nm
Light spot	Circular
Laser class	2, complies with 21 CFR 1040.10 except for the conformance according to "Laser Notice No. 56" from May 8, 2019 (EN 60825-1:2014+A11:2021, IEC 60825-1:2014)
Aperture angle	≤ 50°
Reading distance	45 mm ... 755 mm ¹⁾
Scanning frequency	400 Hz ... 1,200 Hz
Code resolution	0.2 mm ... 1 mm
Oscillating mirror functions	Fixed (adjustable position), oscillating (variable or fixed amplitude), one shot
Oscillation frequency	0.5 Hz ... 6.25 Hz
Angle of deflection	-20° ... 20°

¹⁾ For details see reading field diagram.

Mechanics/electronics

Connection type	1 x 15-pin D-Sub HD male connector (0.9 m)
Supply voltage	18 V DC ... 30 V DC
Power consumption	6.5 W
Housing material	Aluminum die cast
Housing color	Light blue (RAL 5012)
Window material	Glass

¹⁾ At 25 °C.

Enclosure rating	IP65 (EN 60529)
Protection class	III (EN 61140)
Weight	+ 420 g, with connecting cable
Dimensions (L x W x H)	95 mm x 107 mm x 41 mm
MTBF	100,000 h
MTTF	40,000 h (Laser diode) ¹⁾

¹⁾ At 25 °C.

Performance

Readable code structures	1D codes
Bar code types	All current code types, Code 39, Code 128, Code 93, Codabar, GS1-128 / EAN 128, UPC / GTIN / EAN, Interleaved 2 of 5, Pharmacode, GS1 DataBar, Telepen, MSI/Plessey
Code printing process	Label (printed codes)
Print ratio	2:1 ... 3:1
No. of codes per scan	1 ... 20 (Standard decoder) 1 ... 6 (SMART decoder)
No. of codes per reading interval	1 ... 50 (auto-discriminating)
No. of characters per reading interval	5,000 500 (for multiplexer function in CAN operation)
No. of multiple readings	1 ... 99

Interfaces

PROFINET	✓
Type of fieldbus integration	Optional over external fieldbus module CDF600-2
Function	PROFINET Single Port, PROFINET Dual Port
EtherCAT	✓
Type of fieldbus integration	Optional over external fieldbus module CDF600
Serial	✓, RS-232, RS-422, RS-485
Function	Data interface (read result output), Service interface
Data transmission rate	2,400 Baud ... 115.2 kBaud, AUX: 57.6 kBaud (RS-232)
CAN	✓
Function	SICK CAN sensor network CSN (CAN controller/CAN device, multiplexer/server)
Data transmission rate	20 kbit/s ... 1 Mbit/s
CANopen	✓
Data transmission rate	20 kbit/s ... 1 Mbit/s
PROFIBUS DP	✓
Type of fieldbus integration	Optional over external fieldbus module CDF600-2
Digital inputs	4 ("Sensor 1", "Sensor 2", 2 inputs via optional parameter storage CMC600 in CDB620/CDM420)
Digital outputs	4 ("Result 1", "Result 2", 2 outputs via optional parameter storage CMC600 in CDB620/CDM420)
Reading pulse	Digital inputs, non-powered, serial interface, auto pulse, CAN
Optical indicators	6 LEDs (Ready, Result, laser, Data, CAN, LNK TX, Bar graph for displaying the reading rate percentage (10 LEDs))
Acoustic indicators	Beeper/buzzer (can be switched off, can be allocated as a result indication function)
Control elements	2 buttons (choose and start/stop functions)

Configuration software	SOPAS ET
Memory card	MicroSD memory card (flash card), optional

Ambient data

Electromagnetic compatibility (EMC)	EN 61000-6-3 (2001-10) / EN 61000-6-2:2005
Vibration resistance	EN 60068-2-6 (1995)
Shock resistance	EN 60068-2-27 (1993)
Ambient operating temperature	0 °C ... +40 °C
Storage temperature	-20 °C ... +70 °C
Permissible relative humidity	90 %, Non-condensing
Ambient light immunity	2,000 lx, on barcode
Bar code print contrast (PCS)	≥ 60 %

General notes

Note on use	For Ethernet connection please use an Ethernet version of CLV6xx
--------------------	--

Classifications

ECLASS 5.0	27280102
ECLASS 5.1.4	27280102
ECLASS 6.0	27280102
ECLASS 6.2	27280102
ECLASS 7.0	27280102
ECLASS 8.0	27280102
ECLASS 8.1	27280102
ECLASS 9.0	27280102
ECLASS 10.0	27280102
ECLASS 11.0	27280102
ECLASS 12.0	27280102
ETIM 5.0	EC002550
ETIM 6.0	EC002550
ETIM 7.0	EC002550
ETIM 8.0	EC002550
UNSPSC 16.0901	43211701

Dimensional drawing (Dimensions in mm (inch))

CLV63x/64x/65x Standard, oscillating mirror

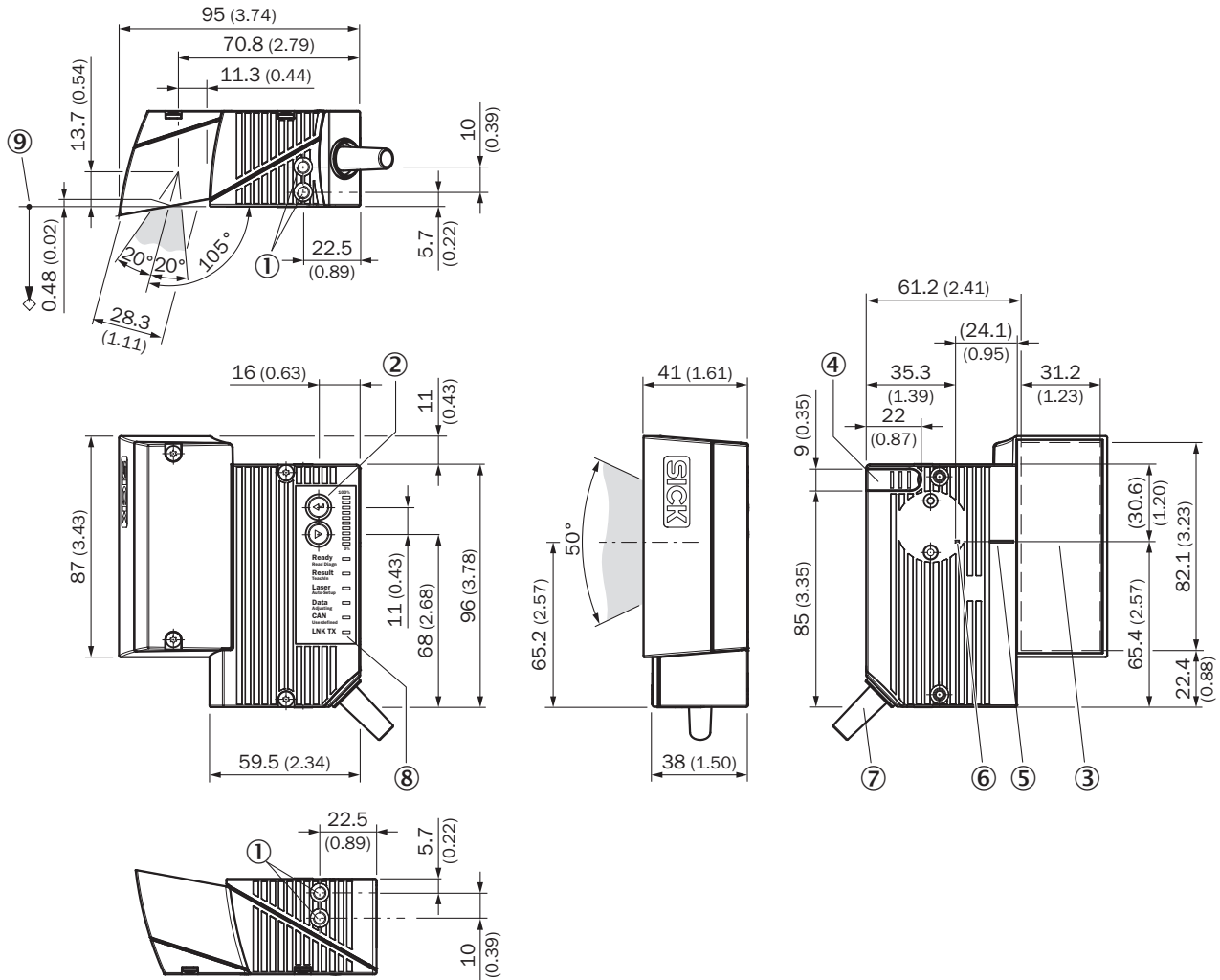

- ① Blind hole thread M5, 5 mm deep (2 x), for mounting
- ② Function button (2 x)
- ③ Reading field
- ④ Cover for the microSD memory card
- ⑤ Central position of the deflected laser beam in the V-shaped aperture angle
- ⑥ Internal impact point: rotation point of the variable direction laser beam
- ⑦ Cable with 15-pin D-sub HD male connector
- ⑧ LED status indicator (6x) and bar graph
- ⑨ Reference point for reading distance (from housing edge to object)

Reading field diagram

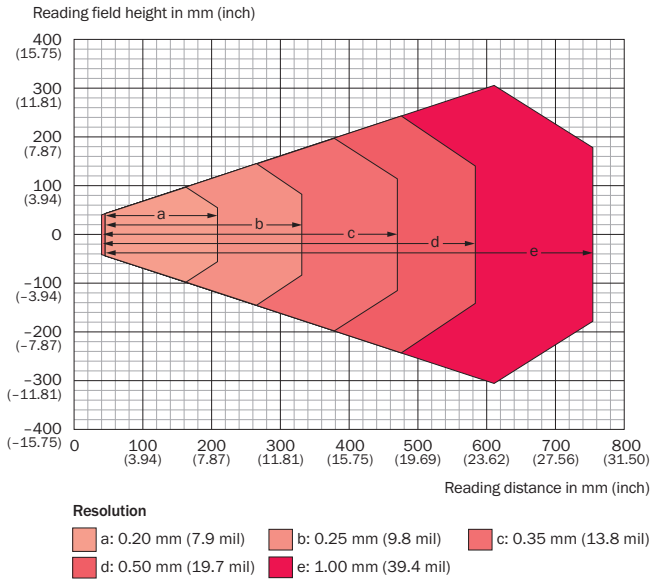

The depth of field is reduced by approx. 10% for devices with plastic lenses.

Deflection width

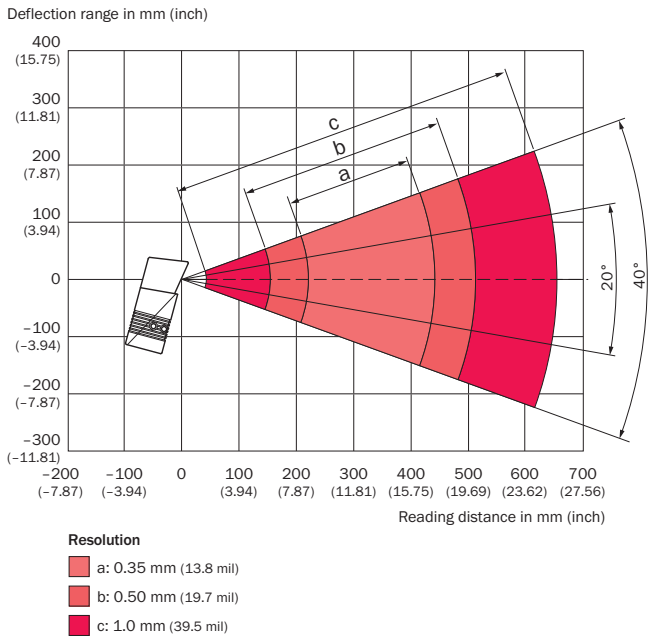

① Diagram applies to focus position of 280 mm

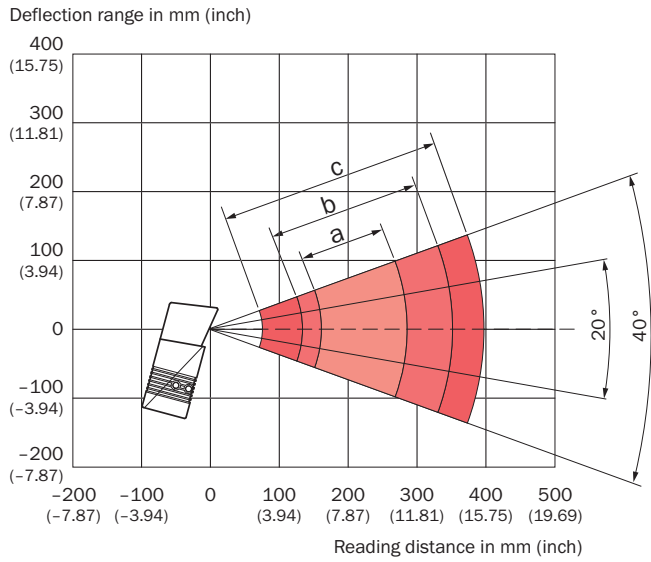

Resolution

- a: 0.25 mm (9.8 mil)
- b: 0.35 mm (13.8 mil)
- c: 0.50 mm (19.7 mil)

① Diagram applies to focus position of 215 mm

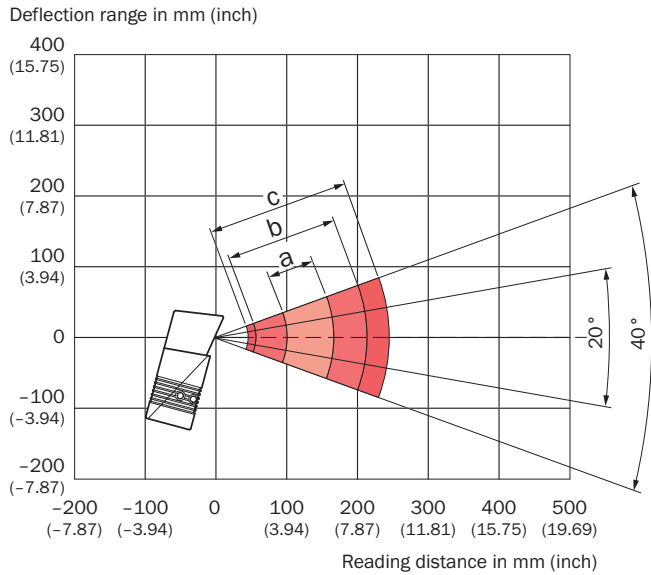





Resolution

- a: 0.20 mm (7.9 mil)
- b: 0.35 mm (13.8 mil)
- c: 0.50 mm (19.7 mil)

① Diagram applies to focus position of 140 mm

Recommended accessories

Other models and accessories → www.sick.com/CLV64x

	Brief description	Type	Part no.
Cloning modules			
	External parameter memory for integration in CDB620/CDB650/CDM42x	CMC600-101	1042259
Modules			
	<ul style="list-style-type: none"> • Accessory group: 4DproConnectivity • Product family: Connection Device Basic • Sub product family: CDB620 • Supported products: CLV61x - CLV65xLector62xRFH6xxRFU62x • Brief description: Small connection module for one sensor, 4 cable glands, base for CMC600 	CDB620-001	1042256
Storage media			
	microSD memory card with 1 GB for industrial use	microSD memory card	4051366
Mounting brackets and plates			
	Hanger-shaped mounting bracket, mounting hardware included	Mounting bracket	2042800

Recommended services

Additional services → www.sick.com/CLV64x

	Type	Part no.
Performance check		
<ul style="list-style-type: none"> • Product area: Fixed mount barcode scanners • Range of services: Inspection of defined functions, e.g., reading performance • Duration: Additional work will be invoiced separately 	Performance check CLV	1682028
Commissioning		
<ul style="list-style-type: none"> • Product area: Fixed mount barcode scanners • Range of services: Inspection of connection, fine adjustment, optimization of parameters of SICK product as well as tests, Setup of previously defined functions of reading configuration, code configuration, data processing and network, interfaces or inputs and outputs • Duration: Additional work will be invoiced separately 	Commissioning CLV61x ... CLV64x	1681925
Extended warranty		
<ul style="list-style-type: none"> • Product area: Machine vision, LiDAR sensors, safety camera sensors, Safety laser scanners, Safety radar sensors, Radar sensors, Fixed mount barcode scanners, Image-based code readers, RFID, Mobile handheld scanners • Range of services: The services correspond to the scope of the statutory manufacturer warranty (SICK general terms of delivery). • Duration: Five-year warranty from delivery date. 	Extended warranty for a total of five years from delivery date	1680671

SICK AT A GLANCE

SICK is one of the leading manufacturers of intelligent sensors and sensor solutions for industrial applications. A unique range of products and services creates the perfect basis for controlling processes securely and efficiently, protecting individuals from accidents and preventing damage to the environment.

We have extensive experience in a wide range of industries and understand their processes and requirements. With intelligent sensors, we can deliver exactly what our customers need. In application centers in Europe, Asia and North America, system solutions are tested and optimized in accordance with customer specifications. All this makes us a reliable supplier and development partner.

Comprehensive services complete our offering: SICK LifeTime Services provide support throughout the machine life cycle and ensure safety and productivity.

For us, that is “Sensor Intelligence.”

WORLDWIDE PRESENCE:

Contacts and other locations –www.sick.com