



# CM30-16BAP-KW1

CM

CAPACITIVE PROXIMITY SENSORS

**SICK**  
Sensor Intelligence.



Illustration may differ



## Ordering information

Type	Part no.
CM30-16BAP-KW1	6028411

Other models and accessories → [www.sick.com/CM](http://www.sick.com/CM)

## Detailed technical data

### Features

<b>Housing</b>	Metric
<b>Thread size</b>	M30 x 1.5
<b>Diameter</b>	Ø 30 mm
<b>Sensing range <math>S_n</math></b>	2 mm ... 16 mm
<b>Safe sensing range <math>S_a</math></b>	11.52 mm
<b>Installation type</b>	Flush
<b>Switching frequency</b>	10 Hz
<b>Connection type</b>	Cable, 2-wire, 2 m <sup>1)</sup>
<b>Output function</b>	NC or NO
<b>Electrical wiring</b>	AC 2-wire
<b>Adjustment</b>	Potentiometer Sensitivity (11 turns)
<b>Enclosure rating</b>	IP67 (According to EN 60529)
<b>Items supplied</b>	Mounting nut, PA12 plastic (2x) Screwdriver for potentiometer adjustment (1 x)

<sup>1)</sup> Do not bend below 0 °C.

### Mechanics/electronics

<b>Supply voltage</b>	20 V AC ... 250 V AC
<b>Ripple</b>	≤ 10 % <sup>1)</sup>
<b>Voltage drop</b>	≤ 10 V DC <sup>2)</sup>
<b>Current consumption</b>	10 mA <sup>3)</sup>

<sup>1)</sup> Of  $U_B$ .

<sup>2)</sup> At  $I_a$  max.

<sup>3)</sup> Without load.

<sup>4)</sup> Of  $S_r$ .

<sup>5)</sup> Supply voltage  $U_B$  and constant ambient temperature  $T_a$ .

<sup>6)</sup> In EMC critical applications, conducted interference levels may lie within the frequency range of the oscillator. This can cause changes to the output signal. (See operating instructions.).

<b>Time delay before availability</b>	≤ 100 ms
<b>Hysteresis</b>	4 % ... 20 %
<b>Reproducibility</b>	≤ 5 % <sup>4) 5)</sup>
<b>Temperature drift (of S<sub>r</sub>)</b>	± 10 %
<b>EMC</b>	According to EN 60947-5-2 <sup>6)</sup>
<b>Continuous current I<sub>a</sub></b>	≤ 500 mA
<b>Cable material</b>	PVC
<b>Conductor size</b>	0.5 mm <sup>2</sup>
<b>Power-up pulse protection</b>	✓
<b>Shock and vibration resistance</b>	30 g, 11 ms / 10 ... 55 Hz, 1 mm
<b>Ambient operating temperature</b>	-25 °C ... +80 °C
<b>Housing material</b>	Plastic, PBT
<b>Housing length</b>	63.6 mm
<b>Thread length</b>	50 mm
<b>Tightening torque, max.</b>	≤ 7.5 Nm

1) Of U<sub>b</sub>.

2) At I<sub>a</sub> max.

3) Without load.

4) Of S<sub>r</sub>.

5) Supply voltage U<sub>B</sub> and constant ambient temperature T<sub>a</sub>.

6) In EMC critical applications, conducted interference levels may lie within the frequency range of the oscillator. This can cause changes to the output signal. (See operating instructions.).

### Safety-related parameters

<b>MTTF<sub>D</sub></b>	815 years
<b>DC<sub>avg</sub></b>	0 %
<b>T<sub>M</sub> (mission time)</b>	20 years

### Reduction factors

<b>Note</b>	The values are reference values which may vary
<b>Metal</b>	1
<b>Water</b>	1
<b>PVC</b>	Approx. 0.4
<b>Oil</b>	Approx. 0.25
<b>Glass</b>	0.6
<b>Ceramics</b>	0.5
<b>Alcohol</b>	0.7
<b>Wood</b>	0.2 ... 0.7

### Installation note

<b>Remark</b>	Associated graphic see "Installation"
<b>B</b>	30 mm
<b>C</b>	30 mm
<b>D</b>	48 mm

Classifications

<b>ECLASS 5.0</b>	27270102
<b>ECLASS 5.1.4</b>	27270102
<b>ECLASS 6.0</b>	27270102
<b>ECLASS 6.2</b>	27270102
<b>ECLASS 7.0</b>	27270102
<b>ECLASS 8.0</b>	27270102
<b>ECLASS 8.1</b>	27270102
<b>ECLASS 9.0</b>	27270102
<b>ECLASS 10.0</b>	27270102
<b>ECLASS 11.0</b>	27270102
<b>ECLASS 12.0</b>	27274201
<b>ETIM 5.0</b>	EC002715
<b>ETIM 6.0</b>	EC002715
<b>ETIM 7.0</b>	EC002715
<b>ETIM 8.0</b>	EC002715
<b>UNSPSC 16.0901</b>	39122230

Installation note

Flush installation

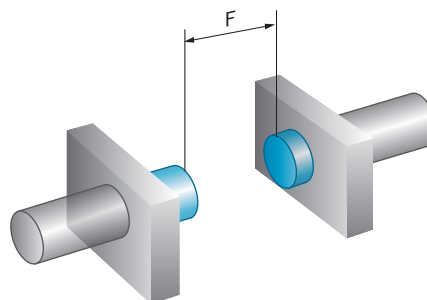
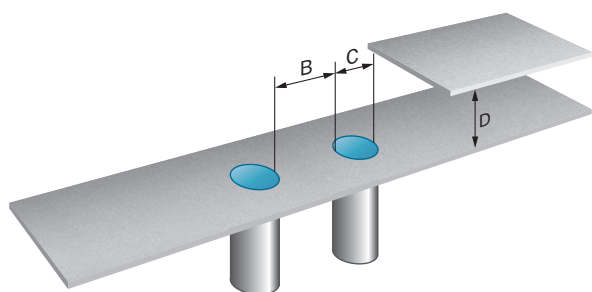

Connection diagram

Cd-013

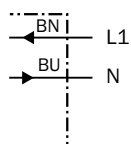

## Response diagram

CM30, Flush installation

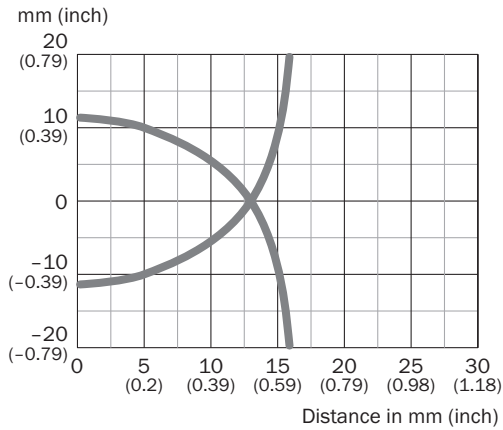

## Dimensional drawing (Dimensions in mm (inch))

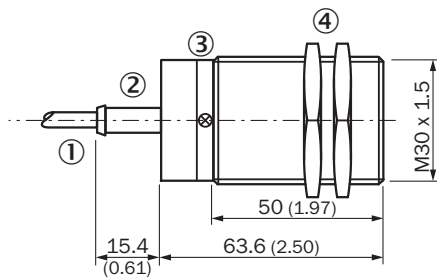

CM30, flush, cable



- ① Connection
- ② Display LED
- ③ Potentiometer for sensitivity adjustment
- ④ Fastening nuts (2 x); 34 mm hex, plastic

## Recommended accessories

Other models and accessories → [www.sick.com/CM](http://www.sick.com/CM)

	Brief description	Type	Part no.
<b>Mounting brackets and plates</b>			
	Mounting plate for M30 sensors, steel, zinc coated, without mounting hardware	BEF-WG-M30	5321871
	Mounting bracket for M30 sensors, steel, zinc coated, without mounting hardware	BEF-WN-M30	5308445

## SICK AT A GLANCE

SICK is one of the leading manufacturers of intelligent sensors and sensor solutions for industrial applications. A unique range of products and services creates the perfect basis for controlling processes securely and efficiently, protecting individuals from accidents and preventing damage to the environment.

We have extensive experience in a wide range of industries and understand their processes and requirements. With intelligent sensors, we can deliver exactly what our customers need. In application centers in Europe, Asia and North America, system solutions are tested and optimized in accordance with customer specifications. All this makes us a reliable supplier and development partner.

Comprehensive services complete our offering: SICK LifeTime Services provide support throughout the machine life cycle and ensure safety and productivity.

For us, that is “Sensor Intelligence.”

## WORLDWIDE PRESENCE:

Contacts and other locations –[www.sick.com](http://www.sick.com)