



# CMB30-25NPPECOSA00

CMB

CAPACITIVE PROXIMITY SENSORS

**SICK**  
Sensor Intelligence.



Illustration may differ



### Ordering information

Type	Part no.
CMB30-25NPPECOSA00	6080644

Other models and accessories → [www.sick.com/CMB](http://www.sick.com/CMB)

### Detailed technical data

#### Features

<b>Housing</b>	Metric
<b>Thread size</b>	M30 x 1.5
<b>Diameter</b>	Ø 30 mm
<b>Sensing range S<sub>n</sub></b>	0 mm ... 25 mm
<b>Safe sensing range S<sub>a</sub></b>	19.13 mm <sup>1)</sup>
<b>Installation type</b>	Non-flush
<b>Switching frequency</b>	50 Hz
<b>Connection type</b>	Male connector M12, 4-pin
<b>Switching output</b>	PNP
<b>Output function</b>	Complementary
<b>Output characteristic</b>	Wire configurable
<b>Electrical wiring</b>	DC 4-wire
<b>Adjustment</b>	
	Potentiometer Sensitivity (11 turns)
	Wire/pin Sensitivity
	IO-Link Sensitivity, sensor parameters and Smart Task functions
<b>Enclosure rating</b>	IP67 IP68 <sup>2)</sup> IP69K
<b>Special features</b>	Visual adjustment indicator, Smart Task, IO-Link
<b>Pin 2 configuration</b>	External input, Teach-in, switching signal
<b>Items supplied</b>	Mounting nut, PA12 plastic (2x)

<sup>1)</sup> For flush mounting in electrically conductive materials Sa = 0.8 x Sr at temperatures <0 °C and >60 °C.

<sup>2)</sup> 1 m water depth / 60 min.

Screwdriver for potentiometer adjustment (1 x)

1) For flush mounting in electrically conductive materials  $S_a = 0.8 \times S_r$  at temperatures  $<0 \text{ }^\circ\text{C}$  and  $>60 \text{ }^\circ\text{C}$ .

2) 1 m water depth / 60 min.

## Mechanics/electronics

<b>Supply voltage</b>	10 V DC ... 36 V DC
<b>Ripple</b>	$\leq 10 \%$ <sup>1)</sup>
<b>Voltage drop</b>	$\leq 2 \text{ V DC}$ <sup>2)</sup>
<b>Current consumption</b>	$\leq 20 \text{ mA}$ <sup>3)</sup>
<b>Time delay before availability</b>	$\leq 300 \text{ ms}$
<b>Hysteresis</b>	3 % ... 20 %
<b>Reproducibility</b>	$\leq 5 \%$ <sup>4) 5)</sup>
<b>Temperature drift (of <math>S_r</math>)</b>	$\pm 10 \%$
<b>EMC</b>	EN 61000-4-2 ESD: $> 40 \text{ kV CD}$ and AD EN 61000-4-3 Radiated RF: 20 V/m EN 61000-4-4 burst: $\pm 4 \text{ kV} / 5 \text{ kHz}$ EN 61000-4-5 Surge: Voltage supply $> 2 \text{ kV}$ with 500 ohm; switching output $> 2 \text{ kV}$ with 500 ohm EN 61000-4-6 HF: $> 20 \text{ V}_{\text{rms}}$ EN 61000-4-8 mains frequency magnetic fields: Permanent $> 60 \text{ A/m}$ , 75,9 $\mu\text{tesla}$ ; briefly $> 600 \text{ A/m}$ , 759 $\mu\text{tesla}$
<b>Continuous current <math>I_a</math></b>	$\leq 200 \text{ mA}$
<b>Short-circuit protection</b>	✓
<b>Power-up pulse protection</b>	✓
<b>Shock and vibration resistance</b>	EN 60068-2-27 shock resistance $E_a$ : 30 g 11 ms; 3 shocks in each direction of the 3 coordinate axes IEC 60068-2-31 drop test: 2 times from 1 m, 100 times from 0.5 m EN 60068-2-6 vibration resistance $F_c$ : 10 Hz ... 150 Hz, 1 mm / 15 g
<b>Ambient operating temperature</b>	$-30 \text{ }^\circ\text{C} \dots +85 \text{ }^\circ\text{C}$ <sup>6)</sup>
<b>Ambient temperature, storage</b>	$-40 \text{ }^\circ\text{C} \dots +85 \text{ }^\circ\text{C}$
<b>Housing material</b>	Plastic, PBT
<b>Housing length</b>	74 mm
<b>Thread length</b>	45.5 mm
<b>Tightening torque, max.</b>	$\leq 7.5 \text{ Nm}$
<b>UL File No.</b>	NRKH.E191603

1) Of  $U_B$ .

2) At  $I_a$  max.

3) Without load.

4) Of  $S_r$ .

5) Supply voltage  $U_B$  and constant ambient temperature  $T_a$ .

6)  $+120 \text{ }^\circ\text{C}$  short time, at the front of the sensor.

## Safety-related parameters

<b>MTTF<sub>D</sub></b>	786 years
<b>DC<sub>avg</sub></b>	0%
<b>T<sub>M</sub> (mission time)</b>	20 years

### Communication interface

<b>Communication interface</b>	IO-Link V1.1
<b>Communication Interface detail</b>	COM2 (38,4 kBaud)
<b>Cycle time</b>	> 5 ms
<b>Process data length</b>	4 Byte
<b>Process data structure</b>	Bit 0 = switching signal Q <sub>L1</sub> Bit 1 = switching signal Q <sub>L2</sub> Bit 2 = Sensor switching channel Q <sub>int1</sub> Bit 3 = Sensor switching channel Q <sub>int2</sub> Bit 4 = Contamination alarm for switching channel Q <sub>int1</sub> Bit 5 = Contamination channel for Q <sub>int2</sub> Bit 6 = Temperature alarm Bit 7 = Short-circuit Bit 16 ... 31 = Analog value (digit value, not linearized)

### Reduction factors

<b>Note</b>	The values are reference values which may vary
<b>Metal</b>	1
<b>Water</b>	1
<b>PVC</b>	Approx. 0.4
<b>Oil</b>	Approx. 0.25
<b>Glass</b>	0.6
<b>Ceramics</b>	0.5
<b>Alcohol</b>	0.7
<b>Wood</b>	0.2 ... 0.7

### Installation note

<b>Remark</b>	Associated graphic see "Installation"
<b>A</b>	30 mm
<b>B</b>	60 mm
<b>C</b>	30 mm
<b>D</b>	75 mm
<b>E</b>	14.5 mm In critical distances, the sensor should be tested in the application
<b>F</b>	75 mm

### Smart Task

<b>Smart Task name</b>	Base logics
<b>Logic function</b>	Direct AND OR Window Hysteresis
<b>Timer function</b>	Deactivated Switch-on delay Off delay ON and OFF delay Impulse (one shot)
<b>Inverter</b>	Yes
<b>Switching signal</b>	
Switching signal Q <sub>L1</sub>	Switching output

Switching signal Q <sub>L2</sub>	Switching output
----------------------------------	------------------

Classifications

<b>ECLASS 5.0</b>	27270102
<b>ECLASS 5.1.4</b>	27270102
<b>ECLASS 6.0</b>	27270102
<b>ECLASS 6.2</b>	27270102
<b>ECLASS 7.0</b>	27270102
<b>ECLASS 8.0</b>	27270102
<b>ECLASS 8.1</b>	27270102
<b>ECLASS 9.0</b>	27270102
<b>ECLASS 10.0</b>	27270102
<b>ECLASS 11.0</b>	27270102
<b>ECLASS 12.0</b>	27274201
<b>ETIM 5.0</b>	EC002715
<b>ETIM 6.0</b>	EC002715
<b>ETIM 7.0</b>	EC002715
<b>ETIM 8.0</b>	EC002715
<b>UNSPSC 16.0901</b>	39122230

Installation note

Non-flush installation

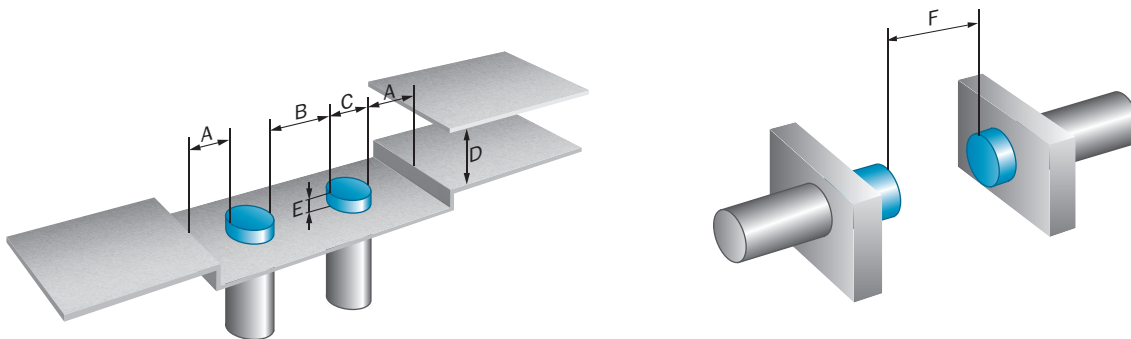

### Connection diagram

Cd-526

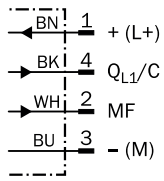

$Q_{L1}/C$  = Switching output,  
 IO-Link communication  
 MF = Multifunction

### Response diagram

CMB30, Non-flush installation

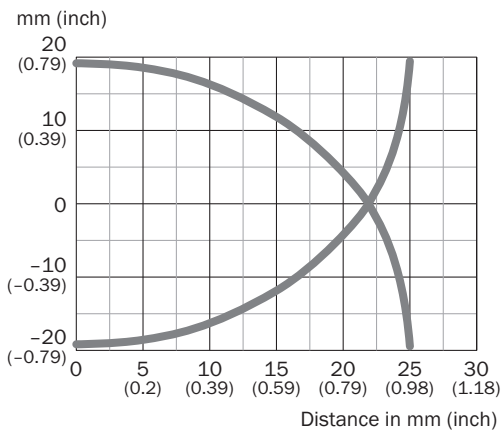

### Dimensional drawing (Dimensions in mm (inch))



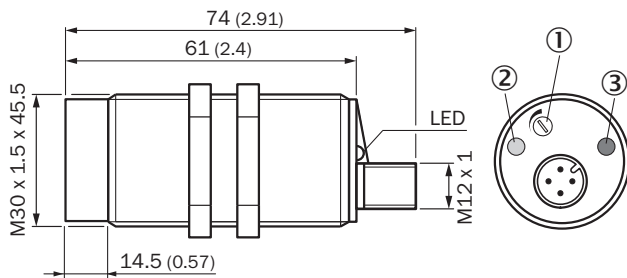



CMB30, non-flush, connector



- ① Potentiometer for sensitivity adjustment
- ② LED yellow: output active
- ③ LED green: operating indicator

## Recommended accessories

 Other models and accessories → [www.sick.com/CMB](http://www.sick.com/CMB)

	Brief description	Type	Part no.
<b>Connection modules</b>			
	IO-Link V1.1 Class A port, USB2.0 port, optional external power supply 24V / 1A	IOLA2US-01101 (SiLink2 Master)	1061790
<b>Mounting brackets and plates</b>			
	Mounting plate for M30 sensors, steel, zinc coated, without mounting hardware	BEF-WG-M30	5321871
	Mounting bracket for M30 sensors, steel, zinc coated, without mounting hardware	BEF-WN-M30	5308445
<b>Terminal and alignment brackets</b>			
	Integrated adapter, Plastic (POM)	BEF-EA-CM30	2043770
	<ul style="list-style-type: none"> <li>• <b>Connection type head A:</b> Male connector, M12, 4-pin, straight, A-coded</li> <li>• <b>Description:</b> Unshielded</li> <li>• <b>Connection systems:</b> Screw-type terminals</li> <li>• <b>Permitted cross-section:</b> ≤ 0.75 mm²</li> </ul>	STE-1204-G	6009932
	<ul style="list-style-type: none"> <li>• <b>Connection type head A:</b> Female connector, M12, 4-pin, straight, A-coded</li> <li>• <b>Connection type head B:</b> Flying leads</li> <li>• <b>Signal type:</b> Sensor/actuator cable</li> <li>• <b>Cable:</b> 5 m, 4-wire, PVC</li> <li>• <b>Description:</b> Sensor/actuator cable, unshielded</li> <li>• <b>Application:</b> Zones with chemicals</li> </ul>	YF2A14-050VB3XLEAX	2096235
<b>Sensor Integration Gateway</b>			
	<ul style="list-style-type: none"> <li>• <b>Further functions:</b> Web server integrated, USB connection for easy configuration of the SIG200 Sensor Integration Gateway with SOPAS ET, the engineering tool from SICK, logic editor is available for easy configuration of logic functions</li> <li>• <b>Connection CONFIG:</b> 1 x M8, 4-pin female connector, USB 2.0 (USB-A)</li> <li>• <b>Logic editor:</b> yes</li> <li>• <b>Communication interface:</b> IO-Link, USB, Ethernet, PROFINET, REST API</li> <li>• <b>Product category:</b> IO-Link Master</li> </ul>	SIG200-0A0412200	1089794

## SICK AT A GLANCE

SICK is one of the leading manufacturers of intelligent sensors and sensor solutions for industrial applications. A unique range of products and services creates the perfect basis for controlling processes securely and efficiently, protecting individuals from accidents and preventing damage to the environment.

We have extensive experience in a wide range of industries and understand their processes and requirements. With intelligent sensors, we can deliver exactly what our customers need. In application centers in Europe, Asia and North America, system solutions are tested and optimized in accordance with customer specifications. All this makes us a reliable supplier and development partner.

Comprehensive services complete our offering: SICK LifeTime Services provide support throughout the machine life cycle and ensure safety and productivity.

For us, that is “Sensor Intelligence.”

## WORLDWIDE PRESENCE:

Contacts and other locations –[www.sick.com](http://www.sick.com)