



CSM-WN1B1C2P

CSM

COLOR SENSORS

SICK
Sensor Intelligence.



Illustration may differ



Ordering information

Type	Part no.
CSM-WN1B1C2P	1122734

Other models and accessories → www.sick.com/CSM

Detailed technical data

Features

Dimensions (W x H x D)	12 mm x 31.5 mm x 21 mm
Sensing distance	≤ 15 mm
Sensing distance tolerance	± 4 mm
Housing design	Small
Light source	LED, RGB ¹⁾
Wave length	640 nm, 525 nm, 470 nm
Light spot size	4.9 mm x 10.1 mm
Light spot direction	Vertical
Adjustment	Teach-in button
Teach-in mode	Teach-in static/dynamic ET: Teach-in dynamic

¹⁾ Average service life: 100,000 h at T_J = +25 °C.

Mechanics/electronics

Supply voltage	12 V DC ... 24 V DC ¹⁾
Ripple	< 5 V _{pp} ²⁾
Current consumption	< 50 mA ³⁾
Switching frequency	1.7 kHz ⁴⁾
Response time	300 μs ⁵⁾

¹⁾ Limit values: DC 12 V (-10 %) ... DC 24 V (+20 %). Operation in short-circuit protected network max. 8 A.

²⁾ May not exceed or fall below U_v tolerances.

³⁾ Without load.

⁴⁾ With light/dark ratio 1:1.

⁵⁾ Signal transit time with resistive load.

⁶⁾ At supply voltage > 24 V, I_{max} = 50 mA. I_{max} is consumption count of all Q_N.

Jitter	150 µs
Switching output	NPN
Switching output (voltage)	NPN: HIGH = approx. U_V / LOW ≤ 2 V
Switching mode	Light/dark switching
Output (channel)	1 color
Output current I_{max}	< 100 mA ⁶⁾
Input, teach-in (ET)	NPN: Teach: $U < 2$ V, Run: $U = 10$ V ... < U_V or open
Connection type	Cable with M12 male connector, 4-pin, 0.2 m
Cable diameter	Ø 3.4 mm
Protection class	III
Circuit protection	U_V connections, reverse polarity protected Output Q short-circuit protected Interference pulse suppression
Enclosure rating	IP67
Weight	Approx. 25 g
Housing material	Plastic, ABS
Optics material	Plastic, PMMA

1) Limit values: DC 12 V (-10 %) ... DC 24 V (+20 %). Operation in short-circuit protected network max. 8 A.

2) May not exceed or fall below U_V tolerances.

3) Without load.

4) With light/dark ratio 1:1.

5) Signal transit time with resistive load.

6) At supply voltage > 24 V, $I_{max} = 50$ mA. I_{max} is consumption count of all Q_n .

Ambient data

Ambient operating temperature	-10 °C ... +55 °C
Ambient temperature, storage	-20 °C ... +75 °C
Shock load	According to IEC 60068
UL File No.	NRKH.E348498 & NRKH7.E348498

Classifications

ECLASS 5.0	27270907
ECLASS 5.1.4	27270907
ECLASS 6.0	27270907
ECLASS 6.2	27270907
ECLASS 7.0	27270907
ECLASS 8.0	27270907
ECLASS 8.1	27270907
ECLASS 9.0	27270907
ECLASS 10.0	27270907
ECLASS 11.0	27270907
ECLASS 12.0	27270907
ETIM 5.0	EC001817
ETIM 6.0	EC001817
ETIM 7.0	EC001817

ETIM 8.0	EC001817
UNSPSC 16.0901	39121528

Connection type/pinouts

Connection type	Cable with M12 male connector, 4-pin, 0.2 m
Connection type Detail	
Cable diameter	Ø 3.4 mm
Conductor cross section	0.15 mm ²
Cable material	PVC
Pinouts	
BN 1	+ (L+)
WH 2	ET
BU 3	- (M)
BK 4	Q

Dimensional drawing (Dimensions in mm (inch))

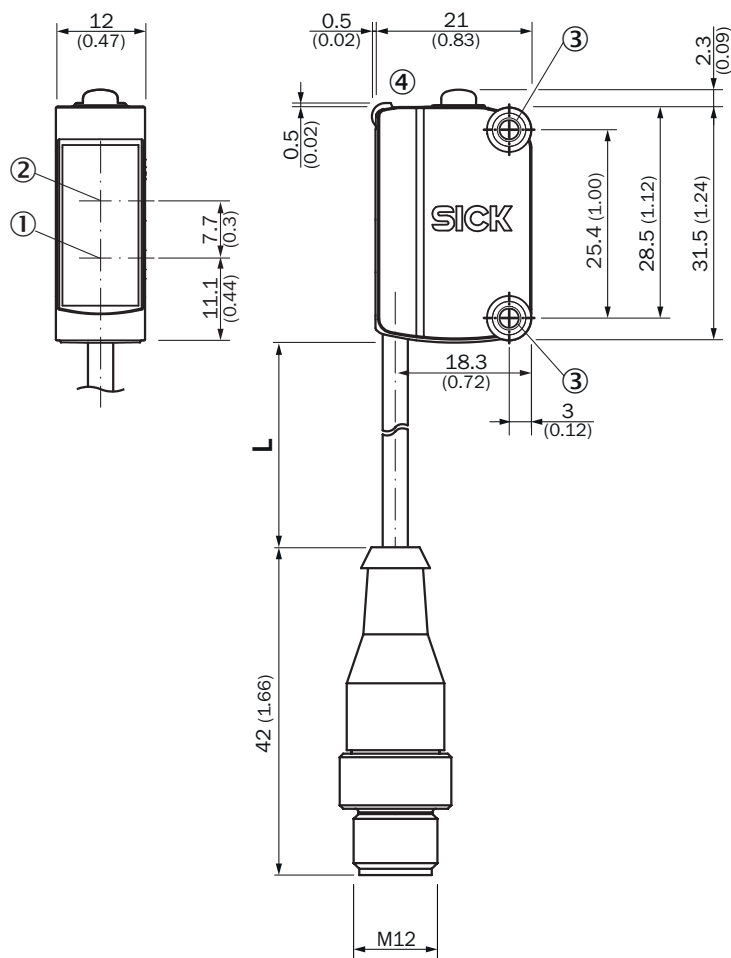

For length of cable (L), see technical data

- ① Center of optical axis, sender
- ② Center of optical axis, receiver
- ③ Mounting holes M3
- ④ Display and adjustment elements

Pinouts

Pinouts, see Technical details: **Connection type/pinouts**

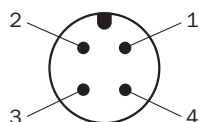

M12 male connector, 4-pin, A-coding

Adjustments

Display and adjustment elements

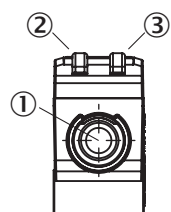

- ① Teach-in button
- ② LED yellow
- ③ LED green

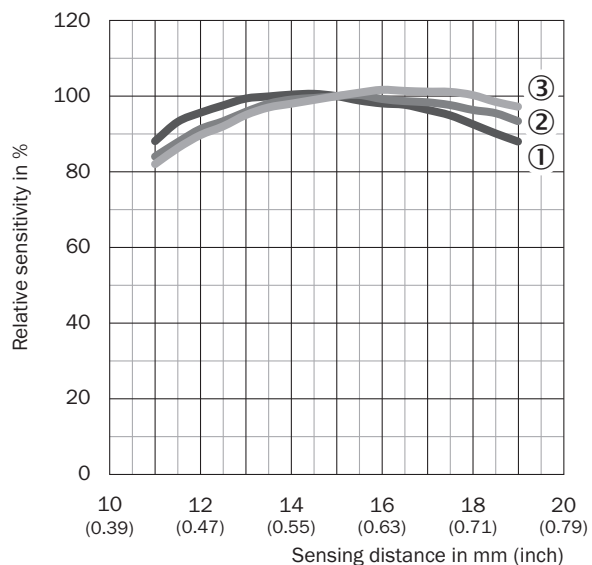

Sensing distance



- ① Red
- ② Green
- ③ Blue

Recommended accessories

Other models and accessories → www.sick.com/CSM

	Brief description	Type	Part no.
Mounting brackets and plates			
	Stainless steel (1.4301)	BEF-WN-G6	2062909
Plug connectors and cables			
	<ul style="list-style-type: none"> • Connection type head A: Male connector, M12, 4-pin, straight • Description: Unshielded • Connection systems: Screw-type terminals • Permitted cross-section: ≤ 0.75 mm² 	STE-1204-G	6009932
Others			
	<ul style="list-style-type: none"> • Connection type head A: Female connector, M12, 4-pin, straight, A-coded • Connection type head B: Flying leads • Signal type: Sensor/actuator cable • Cable: 5 m, 4-wire, PVC • Description: Sensor/actuator cable, unshielded • Application: Zones with chemicals 	YF2A14-050VB3XLEAX	2096235

SICK AT A GLANCE

SICK is one of the leading manufacturers of intelligent sensors and sensor solutions for industrial applications. A unique range of products and services creates the perfect basis for controlling processes securely and efficiently, protecting individuals from accidents and preventing damage to the environment.

We have extensive experience in a wide range of industries and understand their processes and requirements. With intelligent sensors, we can deliver exactly what our customers need. In application centers in Europe, Asia and North America, system solutions are tested and optimized in accordance with customer specifications. All this makes us a reliable supplier and development partner.

Comprehensive services complete our offering: SICK LifeTime Services provide support throughout the machine life cycle and ensure safety and productivity.

For us, that is “Sensor Intelligence.”

WORLDWIDE PRESENCE:

Contacts and other locations –www.sick.com