



CSS-WBF114118RZZZZ

CSS/CSX High Speed

COLOR SENSORS

SICK
Sensor Intelligence.



Illustration may differ



Ordering information

Type	Part no.
CSS-WBF114118RZZZZ	1115223

Other models and accessories → www.sick.com/CSS_CSX_High_Speed

Detailed technical data

Features

Dimensions (W x H x D)	26 mm x 62 mm x 47.5 mm
Sensing distance	13 mm
Sensing distance tolerance	± 5 mm
Housing design	S housing
Light source	LED, RGB ¹⁾
LED risk group marking	1
Wave length	460 nm, 530 nm, 625 nm
Light emission	Long side of housing
Light spot size	2 mm x 4 mm
Light spot direction	Vertical ²⁾
Teach-in mode	Single value teach-in Multi value teach-in
Color mode	C (Color) C + I (Color + Illumination)
Output mode	4 colors in standard mode/best fit mode 15 colors in coded mode
Adjustment of the sensitivity	Continuous: 0 ... 999
Available job banks	4
Output (channel)	4 x hardware switching outputs 24 x virtual switching outputs via RS-485
Parameter presets	None

¹⁾ Average service life: 100,000 h at T_U = +25 °C.

²⁾ In relation to long side of housing.

Mechanics/electronics

Supply voltage	10.8 V DC ... 28.8 V DC ¹⁾
Ripple	$\leq 5 V_{pp}$ ²⁾
Current consumption	$< 120 \text{ mA}$ ³⁾
Switching frequency	13.8 kHz
Response time	36 μs
Jitter	18 μs
Switching output	Push-pull: PNP/NPN
Switching output (voltage)	Push-pull: PNP/NPN HIGH = $U_V - 3 \text{ V}$ /LOW $\leq 3 \text{ V}$
Output current $I_{max.}$	100 mA ⁴⁾
Input, teach-in (ET)	Teach: $U = 10 \text{ V} \dots < V_S$
Input, blanking input (AT)	Blanked: $U = 10 \text{ V} \dots < U_V$
Retention time (ET)	3 s, non-volatile memory
Connection type	Male connector M12, 8-pin
Protection class	III
Circuit protection	U_V connections, reverse polarity protected Output Q short-circuit protected Interference pulse suppression
Enclosure rating	IP67
Weight	68 g
Housing material	VISTAL®
Optics material	PMMA

¹⁾ Limit values: DC 12 V (-10 %) ... DC 24 V (+20 %). Operation in short-circuit protected network max. 8 A.

²⁾ May not fall below or exceed U_V tolerances.

³⁾ Without load.

⁴⁾ Total current of all Outputs.

Communication interface

Modbus	✓, RS-485
Digital output	Q ₁ , Q ₂
Number	2
Digital input	In ₁ , In ₂
Number	2

Ambient data

Ambient operating temperature	-20 °C ... +60 °C
Ambient temperature, storage	-25 °C ... +75 °C
Shock load	According to IEC 60068-2-27 (30 g/11 ms)
UL File No.	E181493

Connection type/pinouts

Connection type	Male connector M12, 8-pin
Pinouts	
WH 1	In ₁
BN 2	+ (L+)

GN 3	Q _{L1}
YE 4	Q _{L2}
GY 5	In ₂
PK 6	RS-485_A
BU 7	-(M)
RD 8	RS-485_B

Classifications

ECLASS 5.0	27270907
ECLASS 5.1.4	27270907
ECLASS 6.0	27270907
ECLASS 6.2	27270907
ECLASS 7.0	27270907
ECLASS 8.0	27270907
ECLASS 8.1	27270907
ECLASS 9.0	27270907
ECLASS 10.0	27270907
ECLASS 11.0	27270907
ECLASS 12.0	27270907
ETIM 5.0	EC001817
ETIM 6.0	EC001817
ETIM 7.0	EC001817
ETIM 8.0	EC001817
UNSPSC 16.0901	39121528

Dimensional drawing (Dimensions in mm (inch))

Dimensional drawing, sensor

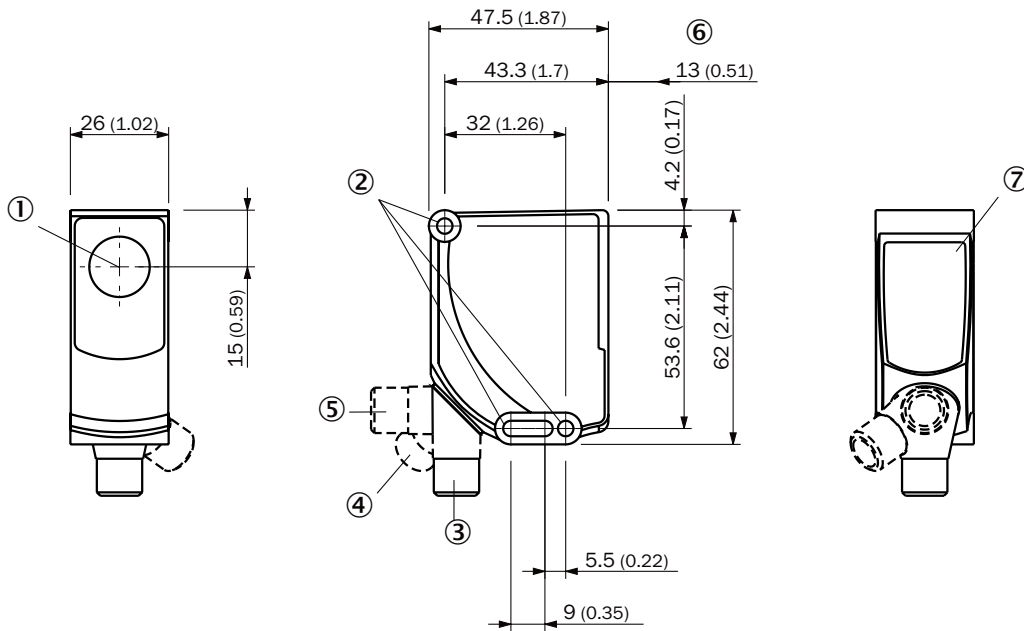

- ① Optical axis
- ② Fixing hole
- ③ M12 male connector, delivery state
- ④ M12 male connector, end stop right
- ⑤ M12 male connector, end stop left
- ⑥ Sensing distance
- ⑦ Display and adjustment elements

Pinouts

Pinouts, see table Technical data: **Connection type/pinouts**

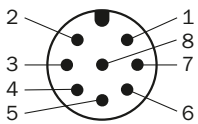

Connector M12, 8-pin, A-coded

Adjustments



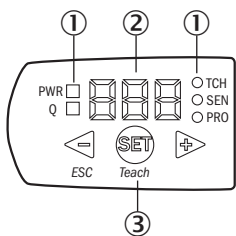

Display and adjustment elements



- ① LEDs (status display)
- ② 7-segment display
- ③ Plus/minus button

Recommended accessories

Other models and accessories → www.sick.com/CSS_CSX_High_Speed

	Brief description	Type	Part no.
Universal bar clamp systems			
	Plate K for universal clamp bracket, steel, zinc coated, Universal clamp (2022726), mounting hardware	BEF-KHS-K01	2022718
	Mounting bar, straight, 200 mm, steel, steel, zinc coated, without mounting hardware	BEF-MS12G-A	4056054
	Mounting bar, L-shaped, 150 mm x 150 mm, steel, steel, zinc coated, without mounting hardware	BEF-MS12L-A	4056052
Mounting brackets and plates			
	Adaptation of CSS High Resolution and CSS High Speed to third party hole pattern, Aluminum, mounting hardware for the sensor included	BEF-AP-CSS	2137662
Others			
	<ul style="list-style-type: none"> • Connection type head A: Female connector, M12, 8-pin, straight, A-coded • Connection type head B: Flying leads • Signal type: Sensor/actuator cable • Cable: 5 m, 8-wire, PUR, halogen-free • Description: Sensor/actuator cable, unshielded • Application: Uncontaminated zones, Zones with oils and lubricants, Robot, Drag chain operation 	YF2A18-050UA5XLEAX	2095653

SICK AT A GLANCE

SICK is one of the leading manufacturers of intelligent sensors and sensor solutions for industrial applications. A unique range of products and services creates the perfect basis for controlling processes securely and efficiently, protecting individuals from accidents and preventing damage to the environment.

We have extensive experience in a wide range of industries and understand their processes and requirements. With intelligent sensors, we can deliver exactly what our customers need. In application centers in Europe, Asia and North America, system solutions are tested and optimized in accordance with customer specifications. All this makes us a reliable supplier and development partner.

Comprehensive services complete our offering: SICK LifeTime Services provide support throughout the machine life cycle and ensure safety and productivity.

For us, that is “Sensor Intelligence.”

WORLDWIDE PRESENCE:

Contacts and other locations –www.sick.com