



# CSX-WNF1142282ZZZZ

CSS/CSX High Speed

COLOR SENSORS

**SICK**  
Sensor Intelligence.



Illustration may differ



### Ordering information

Type	Part no.
CSX-WNF1142282ZZZ	1120182

Other models and accessories → [www.sick.com/CSS\\_CSX\\_High\\_Speed](http://www.sick.com/CSS_CSX_High_Speed)

### Detailed technical data

#### Features

<b>Dimensions (W x H x D)</b>	30 mm x 53 mm x 78.5 mm
<b>Sensing distance</b>	13 mm
<b>Sensing distance tolerance</b>	± 5 mm
<b>Housing design</b>	X housing
<b>Light source</b>	LED, RGB <sup>1)</sup>
<b>LED risk group marking</b>	1
<b>Wave length</b>	460 nm, 530 nm, 625 nm
<b>Light emission</b>	Short device side
<b>Light spot size</b>	2 mm x 4 mm
<b>Light spot direction</b>	Vertical <sup>2)</sup>
<b>Teach-in mode</b>	Single value teach-in Multi value teach-in
<b>Color mode</b>	C (Color) C + I (Color + Illumination)
<b>Output mode</b>	4 colors in standard mode/best fit mode 15 colors in coded mode
<b>Adjustment of the sensitivity</b>	Continuous: 0 ... 999
<b>Available job banks</b>	4
<b>Output (channel)</b>	4 x hardware switching outputs
<b>Parameter presettings</b>	None

<sup>1)</sup> Average service life: 100,000 h at T<sub>J</sub> = +25 °C.

<sup>2)</sup> In relation to long side of housing.

## Mechanics/electronics

<b>Supply voltage</b>	10.8 V DC ... 28.8 V DC <sup>1)</sup>
<b>Ripple</b>	$\leq 5 V_{pp}$ <sup>2)</sup>
<b>Current consumption</b>	$< 120 \text{ mA}$ <sup>3)</sup>
<b>Switching frequency</b>	13.8 kHz
<b>Response time</b>	36 $\mu\text{s}$
<b>Jitter</b>	18 $\mu\text{s}$
<b>Switching output</b>	NPN
<b>Switching output (voltage)</b>	NPN: HIGH = $V_S$ / LOW $\leq 3 \text{ V}$
<b>Output current <math>I_{\text{max}}</math></b>	100 mA <sup>4)</sup>
<b>Input, teach-in (ET)</b>	Teach: $U < 2 \text{ V}$
<b>Input, blanking input (AT)</b>	Blanked: $U < 2 \text{ V}$
<b>Retention time (ET)</b>	3 s, non-volatile memory
<b>Connection type</b>	Male connector M12, 8-pin
<b>Protection class</b>	III
<b>Circuit protection</b>	$U_V$ connections, reverse polarity protected Output Q short-circuit protected Interference pulse suppression
<b>Enclosure rating</b>	IP67
<b>Weight</b>	94 g
<b>Housing material</b>	VISTAL®
<b>Optics material</b>	PMMA

<sup>1)</sup> Limit values: DC 12 V (-10 %) ... DC 24 V (+20 %). Operation in short-circuit protected network max. 8 A.

<sup>2)</sup> May not fall below or exceed  $U_V$  tolerances.

<sup>3)</sup> Without load.

<sup>4)</sup> Total current of all Outputs.

## Communication interface

<b>Digital output</b>	$Q_1 \dots Q_4$
Number	4
<b>Digital input</b>	$In_1, In_2$
Number	2

## Ambient data

<b>Ambient operating temperature</b>	-20 °C ... +60 °C
<b>Ambient temperature, storage</b>	-25 °C ... +75 °C
<b>Shock load</b>	According to IEC 60068-2-27 (30 g/11 ms)
<b>UL File No.</b>	E181493

## Connection type/pinouts

<b>Connection type</b>	Male connector M12, 8-pin
<b>Pinouts</b>	
WH 1	$In_1$
BN 2	+ (L+)
GN 3	$Q_{L1}$

YE 4	QL2
GY 5	In2
PK 6	QL3
BU 7	-(M)
RD 8	QL4

Classifications

<b>ECLASS 5.0</b>	27270907
<b>ECLASS 5.1.4</b>	27270907
<b>ECLASS 6.0</b>	27270907
<b>ECLASS 6.2</b>	27270907
<b>ECLASS 7.0</b>	27270907
<b>ECLASS 8.0</b>	27270907
<b>ECLASS 8.1</b>	27270907
<b>ECLASS 9.0</b>	27270907
<b>ECLASS 10.0</b>	27270907
<b>ECLASS 11.0</b>	27270907
<b>ECLASS 12.0</b>	27270907
<b>ETIM 5.0</b>	EC001817
<b>ETIM 6.0</b>	EC001817
<b>ETIM 7.0</b>	EC001817
<b>ETIM 8.0</b>	EC001817
<b>UNSPSC 16.0901</b>	39121528

Dimensional drawing (Dimensions in mm (inch))

Dimensional drawing, sensor

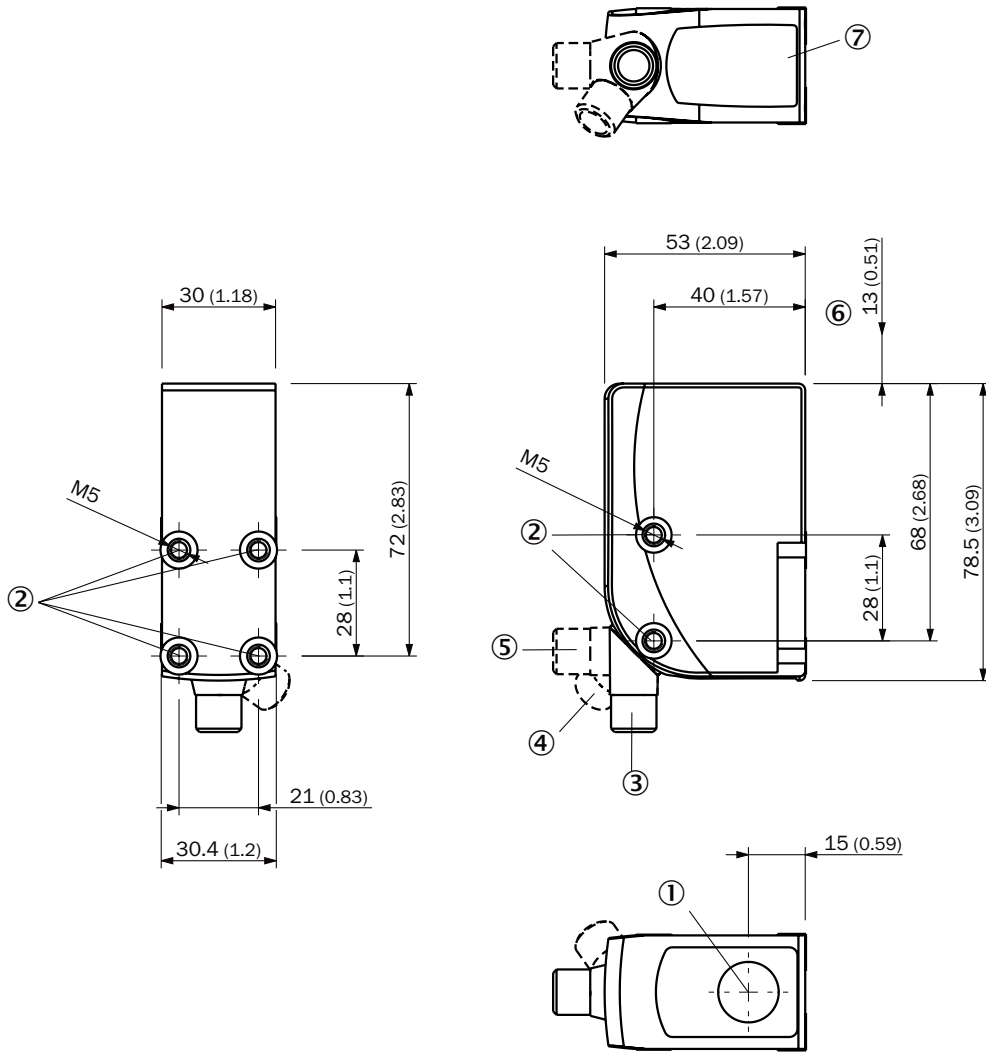

- ① Optical axis
- ② Fixing hole
- ③ M12 male connector, delivery state
- ④ M12 male connector, end stop right
- ⑤ M12 male connector, end stop left
- ⑥ Sensing distance
- ⑦ Display and adjustment elements

Pinouts

Pinouts, see table Technical data: **Connection type/pinouts**

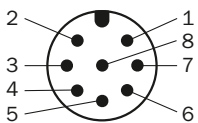

Connector M12, 8-pin, A-coded

### Adjustments



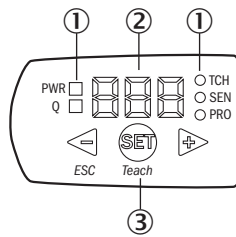

Display and adjustment elements



- ① LEDs (status display)
- ② 7-segment display
- ③ Plus/minus button

### Recommended accessories

Other models and accessories → [www.sick.com/CSS\\_CSX\\_High\\_Speed](http://www.sick.com/CSS_CSX_High_Speed)

	Brief description	Type	Part no.
<b>Universal bar clamp systems</b>			
	Plate K for universal clamp bracket, steel, zinc coated, Universal clamp (2022726), mounting hardware	BEF-KHS-K01	2022718
	Mounting bar, straight, 200 mm, steel, steel, zinc coated, without mounting hardware	BEF-MS12G-A	4056054
	Mounting bar, L-shaped, 150 mm x 150 mm, steel, steel, zinc coated, without mounting hardware	BEF-MS12L-A	4056052
<b>Others</b>			
	<ul style="list-style-type: none"> <li>• <b>Connection type head A:</b> Female connector, M12, 8-pin, straight, A-coded</li> <li>• <b>Connection type head B:</b> Flying leads</li> <li>• <b>Signal type:</b> Sensor/actuator cable</li> <li>• <b>Cable:</b> 5 m, 8-wire, PUR, halogen-free</li> <li>• <b>Description:</b> Sensor/actuator cable, unshielded</li> <li>• <b>Application:</b> Untaminated zones, Zones with oils and lubricants, Robot, Drag chain operation</li> </ul>	YF2A18-050UA5XLEAX	2095653

## SICK AT A GLANCE

SICK is one of the leading manufacturers of intelligent sensors and sensor solutions for industrial applications. A unique range of products and services creates the perfect basis for controlling processes securely and efficiently, protecting individuals from accidents and preventing damage to the environment.

We have extensive experience in a wide range of industries and understand their processes and requirements. With intelligent sensors, we can deliver exactly what our customers need. In application centers in Europe, Asia and North America, system solutions are tested and optimized in accordance with customer specifications. All this makes us a reliable supplier and development partner.

Comprehensive services complete our offering: SICK LifeTime Services provide support throughout the machine life cycle and ensure safety and productivity.

For us, that is “Sensor Intelligence.”

## WORLDWIDE PRESENCE:

Contacts and other locations –[www.sick.com](http://www.sick.com)