



DAXLAN-0100BA080000D00

DAX

MAGNETOSTRICTIVE LINEAR ENCODERS

SICK
Sensor Intelligence.



Illustration may differ

Ordering information

Type	Part no.
DAXLAN-0100BA08000D00	1140180

Mounting brackets and position magnet included. Mounting material for base not included.

Other models and accessories → www.sick.com/DAX



Detailed technical data

Safety-related parameters

MTTF_D (mean time to dangerous failure)	123 years ¹⁾
--	-------------------------

¹⁾ This product is a standard product and does not constitute a safety component as defined in the Machinery Directive. Calculation based on nominal load of components, average ambient temperature 40 °C, frequency of use 8760 h/a. All electronic failures are considered hazardous. For more information, see document no. 8015532.

Performance

Linearity	≤ 0.03% F.S. (Minimum 90 μm) ^{1) 2)}
Repeatability	≤ ± 20 μm
Measured values	Positioning
Measuring range	0 mm ... 100 mm
Unusable range	
Null zone	55 mm
Damping zone	63 mm
Magnet type	
Magnet shape	Block magnet
Configured for number of magnets	1 piece
Magnet travel speed	Any
Measuring frequency (internal)	< 2 ms

¹⁾ Systematic position measurement deviation according to DIN ISO 1319-1 (value includes all systematic errors or deviations from the actual position value, e.g. repeatability and hysteresis).

²⁾ In principle, the size of the measurement deviation is limited by the resolution of the interface.

Interfaces

Communication interface	Analog
Communication Interface detail	Current
Output signal	4 mA ... 20 mA
Signals	
Number of signals	One output signal
Sequence of signals	Rising
Load resistance	100 Ω ... 500 Ω

Electrical data

Connection type	Male connector, M12, 5-pin
PIN assignment	1=+24 V DC; 2=Signal 1; 3=Power ground; 4=N.C.; 5=Output signal ground (0 V)
Male connector coding	A-coded
Supply voltage	24 V DC ($\pm 20\%$)
Current consumption	50...100 mA
Reverse polarity protection	Up to -30 V DC
Residual ripple	≤ 0.28 V _{pp}
Dielectric strength	500 V DC, 0 V against housing
Over voltage protection	≤ 36 V DC
MTTFd: mean time to dangerous failure	123 years ¹⁾

¹⁾ This product is a standard product and does not constitute a safety component as defined in the Machinery Directive. Calculation based on nominal load of components, average ambient temperature 40 °C, frequency of use 8760 h/a. All electronic failures are considered hazardous. For more information, see document no. 8015532.

Mechanical data

Mechanical design	DAX Low Profile
Material	
Housing	Aluminum (anodised), zinc, stainless steel, brass
Mounting bracket	Stainless steel 1.4301

Ambient data

EMC	According to EN 61000-6-2 and EN 61000-6-4
Enclosure rating	IP65 / IP67 ¹⁾
Temperature	
Operating temperature range	-40 °C ... $+85$ °C
Storage temperature range	-40 °C ... $+85$ °C
Permissible relative humidity	90 % (Condensation not permitted)
Resistance to shocks	100 g, 6 ms (IEC 60068-2-27)
Resistance to vibration	8 g / 10...2,000 Hz according to IEC 60068-2-6 ²⁾

¹⁾ In correctly assembled mating connector.

²⁾ Resonance frequencies can influence signal quality.

General notes

Items supplied	Mounting brackets and position magnet included. Mounting material for base not included.
-----------------------	--

Classifications

ECLASS 5.0	27270705
ECLASS 5.1.4	27270705
ECLASS 6.0	27270705
ECLASS 6.2	27270705
ECLASS 7.0	27270705
ECLASS 8.0	27270705
ECLASS 8.1	27270705

ECLASS 9.0	27270705
ECLASS 10.0	27270705
ECLASS 11.0	27270705
ECLASS 12.0	27274304
ETIM 5.0	EC002544
ETIM 6.0	EC002544
ETIM 7.0	EC002544
ETIM 8.0	EC002544
UNSPSC 16.0901	41111613

Dimensional drawing (Dimensions in mm (inch))

DAX Low Profile

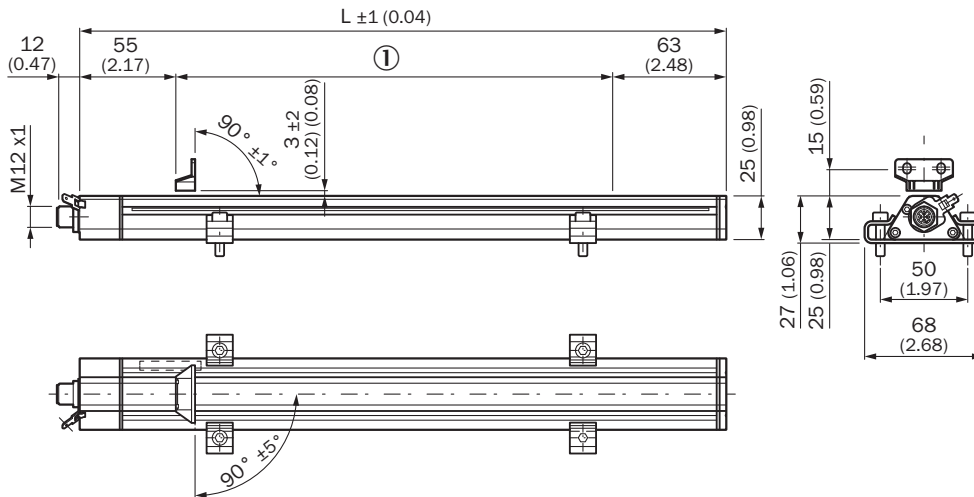

① Measuring range

Distance tolerance

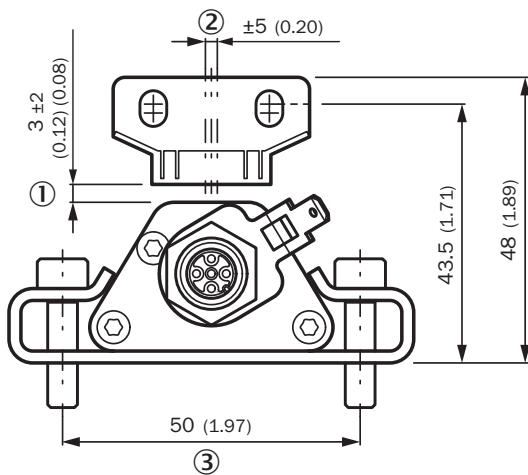

① Nominal distance + permissible amount of distance tolerance

② Permissible center offset

③ Recommendation: M5 x 20

Positioning of mounting bracket



Block magnet



PIN assignment

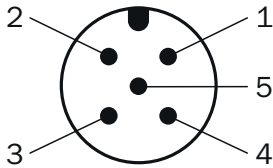

Male connector M12, 5-pin	Signal
1	+24 V DC
2	Signal 1
3	Power Ground
4	n.c.
5	Output signal ground (0 V)

Recommended accessories

Other models and accessories → www.sick.com/DAX

	Brief description	Type	Part no.
Magnets			
	Compact block magnet for magnetostrictive linear encoders	MAG-B-180-01	2129171

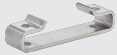
	Brief description	Type	Part no.
Terminal and alignment brackets			
	Replacement clamping bracket for DAX® Low Profile without fastening material, 2 pieces	BEF-KH-LP1-02	2125244
	Replacement clamping bracket for DAX® Low Profile without fastening material, 3 pieces	BEF-KH-LP1-03	2125245
	Replacement clamping bracket for DAX® Low Profile without fastening material, 4 pieces	BEF-KH-LP1-04	2125246

SICK AT A GLANCE

SICK is one of the leading manufacturers of intelligent sensors and sensor solutions for industrial applications. A unique range of products and services creates the perfect basis for controlling processes securely and efficiently, protecting individuals from accidents and preventing damage to the environment.

We have extensive experience in a wide range of industries and understand their processes and requirements. With intelligent sensors, we can deliver exactly what our customers need. In application centers in Europe, Asia and North America, system solutions are tested and optimized in accordance with customer specifications. All this makes us a reliable supplier and development partner.

Comprehensive services complete our offering: SICK LifeTime Services provide support throughout the machine life cycle and ensure safety and productivity.

For us, that is “Sensor Intelligence.”

WORLDWIDE PRESENCE:

Contacts and other locations –www.sick.com