



DAXSVN-0305SA000900M01

DAX

MAGNETOSTRICTIVE LINEAR ENCODERS

**SICK**  
Sensor Intelligence.



Illustration may differ

### Ordering information

Type	Part no.
DAXSVN-0305SA000900M01	1143499

Mounting brackets and position magnet included. Mounting material for base not included.

Other models and accessories → [www.sick.com/DAX](http://www.sick.com/DAX)



### Detailed technical data

#### Safety-related parameters

<b>MTTF<sub>D</sub> (mean time to dangerous failure)</b>	123 years <sup>1)</sup>
--	-------------------------

<sup>1)</sup> This product is a standard product and does not constitute a safety component as defined in the Machinery Directive. Calculation based on nominal load of components, average ambient temperature 40 °C, frequency of use 8760 h/a. All electronic failures are considered hazardous. For more information, see document no. 8015532.

#### Performance

<b>Linearity</b>	≤ 0.02% F.S. (Minimum 60 μm) <sup>1) 2)</sup>
<b>Repeatability</b>	≤ ± 20 μm
<b>Measured values</b>	Positioning
<b>Measuring range</b>	0 mm ... 305 mm
<b>Unusable range</b>	
Null zone	25 mm
Damping zone	63 mm
<b>Magnet type</b>	
Magnet shape	Slide magnet
Configured for number of magnets	1 piece
<b>Magnet travel speed</b>	≤ 10 m/s
<b>Measuring frequency (internal)</b>	< 2 ms

<sup>1)</sup> Systematic position measurement deviation according to DIN ISO 1319-1 (value includes all systematic errors or deviations from the actual position value, e.g. repeatability and hysteresis).

<sup>2)</sup> In principle, the size of the measurement deviation is limited by the resolution of the interface.

#### Interfaces

<b>Communication interface</b>	Analog
<b>Communication Interface detail</b>	Voltage
<b>Output signal</b>	0 V ... 10 V
<b>Signals</b>	
Number of signals	Two output signals (one output signal + an inverted second output signal)
Sequence of signals	Signal 1: rising, signal 2: falling
<b>Load resistance</b>	> 10 kΩ

## Electrical data

<b>Connection type</b>	Male connector, M12, 8-pin
<b>PIN assignment</b>	1=Output signal ground (0 V PIN 3); 2=Output signal ground (0 V PIN 5); 3=Signal 2; 4=n.c.; 5=Signal 1; 6=Power ground; 7=+24 V DC; 8=n.c.
<b>Male connector coding</b>	A-coded
<b>Supply voltage</b>	24 V DC ( $\pm 20\%$ )
<b>Reverse polarity protection</b>	Up to $-30$ V DC
<b>Residual ripple</b>	$\leq 0.28$ V <sub>pp</sub>
<b>Dielectric strength</b>	500 V DC, 0 V against housing
<b>Over voltage protection</b>	$\leq 36$ V DC
<b>MTTF: mean time to dangerous failure</b>	123 years <sup>1)</sup>

<sup>1)</sup> This product is a standard product and does not constitute a safety component as defined in the Machinery Directive. Calculation based on nominal load of components, average ambient temperature 40 °C, frequency of use 8760 h/a. All electronic failures are considered hazardous. For more information, see document no. 8015532.

## Mechanical data

<b>Mechanical design</b>	DAX Slider
<b>Material</b>	
Housing	Aluminum (anodised), zinc, stainless steel, brass
Mounting bracket	Stainless steel 1.4301

## Ambient data

<b>EMC</b>	According to EN 61000-6-2 and EN 61000-6-4
<b>Enclosure rating</b>	IP65 / IP67 <sup>1)</sup>
<b>Temperature</b>	
Operating temperature range	$-40$ °C ... $+85$ °C
Storage temperature range	$-40$ °C ... $+85$ °C
<b>Permissible relative humidity</b>	90 % (Condensation not permitted)
<b>Resistance to shocks</b>	100 g, 6 ms (IEC 60068-2-27)
<b>Resistance to vibration</b>	15 g / 10...2,000 Hz according to IEC 60068-2-6

<sup>1)</sup> In correctly assembled mating connector.

## General notes

<b>Items supplied</b>	Mounting brackets and position magnet included. Mounting material for base not included.
-----------------------	--

## Classifications

<b>ECLASS 5.0</b>	27270705
<b>ECLASS 5.1.4</b>	27270705
<b>ECLASS 6.0</b>	27270705
<b>ECLASS 6.2</b>	27270705
<b>ECLASS 7.0</b>	27270705
<b>ECLASS 8.0</b>	27270705
<b>ECLASS 8.1</b>	27270705
<b>ECLASS 9.0</b>	27270705
<b>ECLASS 10.0</b>	27270705

<b>ECLASS 11.0</b>	27270705
<b>ECLASS 12.0</b>	27274304
<b>ETIM 5.0</b>	EC002544
<b>ETIM 6.0</b>	EC002544
<b>ETIM 7.0</b>	EC002544
<b>ETIM 8.0</b>	EC002544
<b>UNSPSC 16.0901</b>	41111613

### Dimensional drawing (Dimensions in mm (inch))

Positioning of mounting bracket

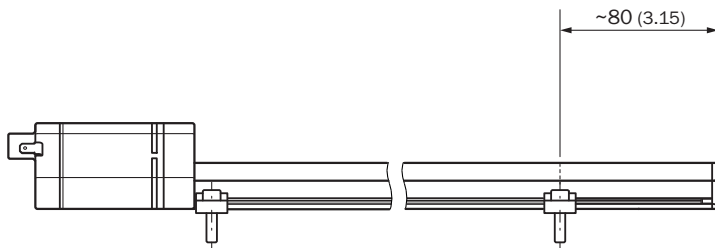

### DAX Slider

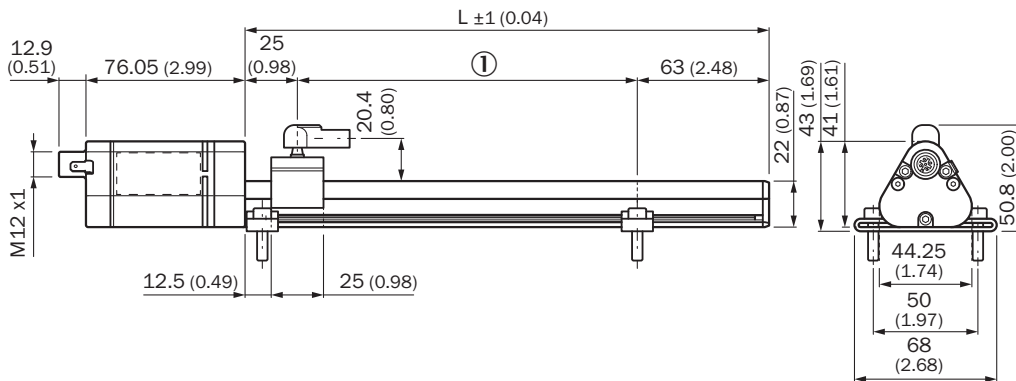

① Measuring range

Slide magnet

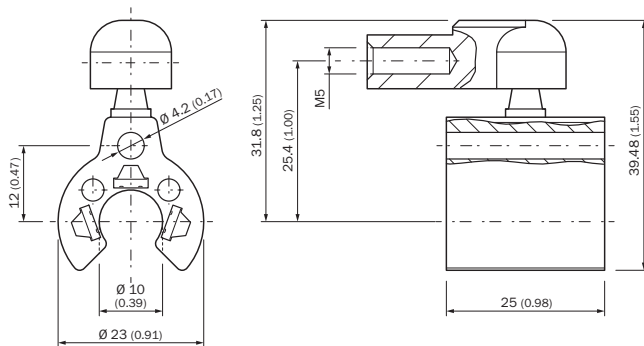



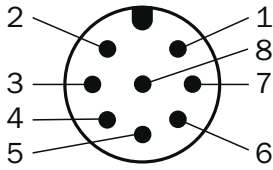

PIN assignment









M12 male connector, 8-pin	Signal
1	Output signal ground (0 V PIN 3)
2	Output signal ground (0 V PIN 5)
3	Signal 2
4	n.c.
5	Signal 1
6	Power Ground
7	+24 V DC
8	n.c.

Recommended accessories

Other models and accessories → [www.sick.com/DAX](http://www.sick.com/DAX)

	Brief description	Type	Part no.
<b>Magnets</b>			
	Slide magnet for magnetostrictive linear encoders	MAG-S-H29-01	2129172
<b>Terminal and alignment brackets</b>			
	Replacement clamping bracket for DAX® Slider without fastening material, 2 pieces	BEF-KH-SL1-02	2125240
	Replacement clamping bracket for DAX® Slider without fastening material, 3 pieces	BEF-KH-SL1-03	2125241
	Replacement clamping bracket for DAX® Slider without fastening material, 4 pieces	BEF-KH-SL1-04	2125242
<b>Others</b>			
	<ul style="list-style-type: none"> <li><b>Connection type head A:</b> Female connector, M12, 8-pin, straight</li> <li><b>Connection type head B:</b> Flying leads</li> <li><b>Signal type:</b> Incremental, SSI</li> <li><b>Cable:</b> 2 m, 8-wire, PUR, halogen-free</li> <li><b>Description:</b> Incremental, SSI, shielded, Head A: female connector, M12, 8-pin, straight Head B: cable Cable: suitable for drag chain, PVC, shielded, 4 x 2 x 0.25 mm<sup>2</sup>, Ø 7.0 mm</li> <li><b>Connection systems:</b> Flying leads</li> </ul>	DOL-1208-G02MAC1	6032866
	<ul style="list-style-type: none"> <li><b>Connection type head A:</b> Female connector, M12, 8-pin, straight</li> <li><b>Connection type head B:</b> Flying leads</li> <li><b>Signal type:</b> Incremental, SSI</li> <li><b>Cable:</b> 5 m, 8-wire, PUR, halogen-free</li> <li><b>Description:</b> Incremental, SSI, shielded, Head A: female connector, M12, 8-pin, straight Head B: cable Cable: suitable for drag chain, PVC, shielded, 4 x 2 x 0.25 mm<sup>2</sup>, Ø 7.0 mm</li> <li><b>Connection systems:</b> Flying leads</li> </ul>	DOL-1208-G05MAC1	6032867

	Brief description	Type	Part no.
	<ul style="list-style-type: none"> <li>• <b>Connection type head A:</b> Female connector, M12, 8-pin, straight</li> <li>• <b>Connection type head B:</b> Flying leads</li> <li>• <b>Signal type:</b> Incremental, SSI</li> <li>• <b>Cable:</b> 10 m, 8-wire, PUR, halogen-free</li> <li>• <b>Description:</b> Incremental, SSI, shielded, Head A: female connector, M12, 8-pin, straight Head B: cable Cable: suitable for drag chain, PVC, shielded, 4 x 2 x 0.25 mm<sup>2</sup>, Ø 7.0 mm</li> <li>• <b>Connection systems:</b> Flying leads</li> </ul>	DOL-1208-G10MAC1	6032868
	<ul style="list-style-type: none"> <li>• <b>Connection type head A:</b> Female connector, M12, 8-pin, straight</li> <li>• <b>Connection type head B:</b> Flying leads</li> <li>• <b>Signal type:</b> Incremental, SSI</li> <li>• <b>Cable:</b> 20 m, 8-wire, PUR, halogen-free</li> <li>• <b>Description:</b> Incremental, SSI, shielded, Head A: female connector, M12, 8-pin, straight Head B: cable Cable: suitable for drag chain, PVC, shielded, 4 x 2 x 0.25 mm<sup>2</sup>, Ø 7.0 mm</li> <li>• <b>Connection systems:</b> Flying leads</li> </ul>	DOL-1208-G20MAC1	6032869
	<ul style="list-style-type: none"> <li>• <b>Connection type head A:</b> Female connector, M12, 8-pin, straight</li> <li>• <b>Connection type head B:</b> Flying leads</li> <li>• <b>Signal type:</b> Incremental, SSI</li> <li>• <b>Cable:</b> 25 m, 8-wire, PUR, halogen-free</li> <li>• <b>Description:</b> Incremental, SSI, shielded, Head A: female connector, M12, 8-pin, straight Head B: cable Cable: suitable for drag chain, PVC, shielded, 4 x 2 x 0.25 mm<sup>2</sup>, Ø 7.0 mm</li> <li>• <b>Connection systems:</b> Flying leads</li> </ul>	DOL-1208-G25MAC1	6067859
	<ul style="list-style-type: none"> <li>• <b>Connection type head A:</b> Female connector, M12, 8-pin, straight, A-coded</li> <li>• <b>Signal type:</b> Incremental, SSI</li> <li>• <b>Cable:</b> CAT5, CAT5e</li> <li>• <b>Description:</b> Incremental, SSI, shielded, Head A: female connector, M12, 8-pin, straight, A encoded, shielded, for cable diameter 4 mm ... 8 mm Head B: - Operating temperature: -40 °C ... +85 °C</li> <li>• <b>Connection systems:</b> IDC quick connection</li> <li>• <b>Permitted cross-section:</b> 0.14 mm<sup>2</sup> ... 0.34 mm<sup>2</sup></li> </ul>	DOS-1208-GA01	6045001
	<ul style="list-style-type: none"> <li>• <b>Connection type head A:</b> Flying leads</li> <li>• <b>Connection type head B:</b> Flying leads</li> <li>• <b>Signal type:</b> SSI, Incremental, HIPERFACE®</li> <li>• <b>Cable:</b> 8-wire, PUR, halogen-free</li> <li>• <b>Description:</b> SSI, Incremental, HIPERFACE®, shielded</li> </ul>	LTG-2308-MWENC	6027529
	<ul style="list-style-type: none"> <li>• <b>Connection type head A:</b> Flying leads</li> <li>• <b>Connection type head B:</b> Flying leads</li> <li>• <b>Signal type:</b> SSI, TTL, HTL, Incremental</li> <li>• <b>Cable:</b> 12-wire, UV and saltwater-resistant, PUR, halogen-free</li> <li>• <b>Description:</b> SSI, TTL, HTL, Incremental, shielded, Head A: cable Head B: cable Cable: suitable for drag chain, PUR, halogen-free, shielded, UV and saltwater resistant, 4 x 2 x 0.25 mm<sup>2</sup> + 2 x 0.5 mm<sup>2</sup> + 2 x 0.14 mm<sup>2</sup>, Ø 7.8 mm</li> </ul>	LTG-2612-MW	6028516

## SICK AT A GLANCE

SICK is one of the leading manufacturers of intelligent sensors and sensor solutions for industrial applications. A unique range of products and services creates the perfect basis for controlling processes securely and efficiently, protecting individuals from accidents and preventing damage to the environment.

We have extensive experience in a wide range of industries and understand their processes and requirements. With intelligent sensors, we can deliver exactly what our customers need. In application centers in Europe, Asia and North America, system solutions are tested and optimized in accordance with customer specifications. All this makes us a reliable supplier and development partner.

Comprehensive services complete our offering: SICK LifeTime Services provide support throughout the machine life cycle and ensure safety and productivity.

For us, that is “Sensor Intelligence.”

## WORLDWIDE PRESENCE:

Contacts and other locations –[www.sick.com](http://www.sick.com)