



DAXSVN-0500SA000900M01

DAX

MAGNETOSTRICTIVE LINEAR ENCODERS

SICK
Sensor Intelligence.



Illustration may differ

Ordering information

| Type | Part no. |
|------------------------|----------|
| DAXSVN-0500SA000900M01 | 1143418 |

Mounting brackets and position magnet included. Mounting material for base not included.

Other models and accessories → www.sick.com/DAX



Detailed technical data

Safety-related parameters

| | |
|--|-------------------------|
| MTTF_D (mean time to dangerous failure) | 123 years ¹⁾ |
|--|-------------------------|

¹⁾ This product is a standard product and does not constitute a safety component as defined in the Machinery Directive. Calculation based on nominal load of components, average ambient temperature 40 °C, frequency of use 8760 h/a. All electronic failures are considered hazardous. For more information, see document no. 8015532.

Performance

| | |
|---------------------------------------|---|
| Linearity | ≤ 0.02% F.S. (Minimum 60 μm) ^{1) 2)} |
| Repeatability | ≤ ± 20 μm |
| Measured values | Positioning |
| Measuring range | 0 mm ... 500 mm |
| Unusable range | |
| Null zone | 25 mm |
| Damping zone | 63 mm |
| Magnet type | |
| Magnet shape | Slide magnet |
| Configured for number of magnets | 1 piece |
| Magnet travel speed | ≤ 10 m/s |
| Measuring frequency (internal) | < 2 ms |

¹⁾ Systematic position measurement deviation according to DIN ISO 1319-1 (value includes all systematic errors or deviations from the actual position value, e.g. repeatability and hysteresis).

²⁾ In principle, the size of the measurement deviation is limited by the resolution of the interface.

Interfaces

| | |
|---------------------------------------|---|
| Communication interface | Analog |
| Communication Interface detail | Voltage |
| Output signal | 0 V ... 10 V |
| Signals | |
| Number of signals | Two output signals (one output signal + an inverted second output signal) |
| Sequence of signals | Signal 1: rising, signal 2: falling |
| Load resistance | > 10 kΩ |

Electrical data

| | |
|---|--|
| Connection type | Male connector, M12, 8-pin |
| PIN assignment | 1=Output signal ground (0 V PIN 3); 2=Output signal ground (0 V PIN 5); 3=Signal 2; 4=n.c.; 5=Signal 1; 6=Power ground; 7=+24 V DC; 8=n.c. |
| Male connector coding | A-coded |
| Supply voltage | 24 V DC ($\pm 20\%$) |
| Reverse polarity protection | Up to -30 V DC |
| Residual ripple | ≤ 0.28 V _{pp} |
| Dielectric strength | 500 V DC, 0 V against housing |
| Over voltage protection | ≤ 36 V DC |
| MTTF: mean time to dangerous failure | 123 years ¹⁾ |

¹⁾ This product is a standard product and does not constitute a safety component as defined in the Machinery Directive. Calculation based on nominal load of components, average ambient temperature 40 °C, frequency of use 8760 h/a. All electronic failures are considered hazardous. For more information, see document no. 8015532.

Mechanical data

| | |
|--------------------------|---|
| Mechanical design | DAX Slider |
| Material | |
| Housing | Aluminum (anodised), zinc, stainless steel, brass |
| Mounting bracket | Stainless steel 1.4301 |

Ambient data

| | |
|--------------------------------------|---|
| EMC | According to EN 61000-6-2 and EN 61000-6-4 |
| Enclosure rating | IP65 / IP67 ¹⁾ |
| Temperature | |
| Operating temperature range | -40 °C ... $+85$ °C |
| Storage temperature range | -40 °C ... $+85$ °C |
| Permissible relative humidity | 90 % (Condensation not permitted) |
| Resistance to shocks | 100 g, 6 ms (IEC 60068-2-27) |
| Resistance to vibration | 15 g / 10...2,000 Hz according to IEC 60068-2-6 |

¹⁾ In correctly assembled mating connector.

General notes

| | |
|-----------------------|--|
| Items supplied | Mounting brackets and position magnet included. Mounting material for base not included. |
|-----------------------|--|

Classifications

| | |
|---------------------|----------|
| ECLASS 5.0 | 27270705 |
| ECLASS 5.1.4 | 27270705 |
| ECLASS 6.0 | 27270705 |
| ECLASS 6.2 | 27270705 |
| ECLASS 7.0 | 27270705 |
| ECLASS 8.0 | 27270705 |
| ECLASS 8.1 | 27270705 |
| ECLASS 9.0 | 27270705 |
| ECLASS 10.0 | 27270705 |

| | |
|-----------------------|----------|
| ECLASS 11.0 | 27270705 |
| ECLASS 12.0 | 27274304 |
| ETIM 5.0 | EC002544 |
| ETIM 6.0 | EC002544 |
| ETIM 7.0 | EC002544 |
| ETIM 8.0 | EC002544 |
| UNSPSC 16.0901 | 41111613 |

Dimensional drawing (Dimensions in mm (inch))

Positioning of mounting bracket

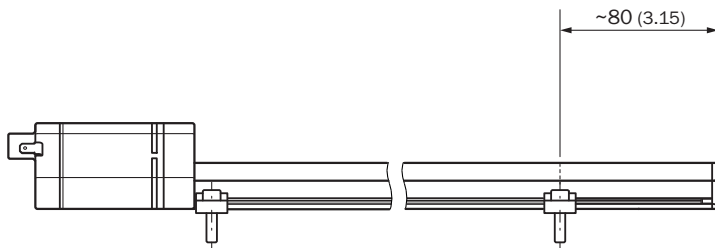

DAX Slider

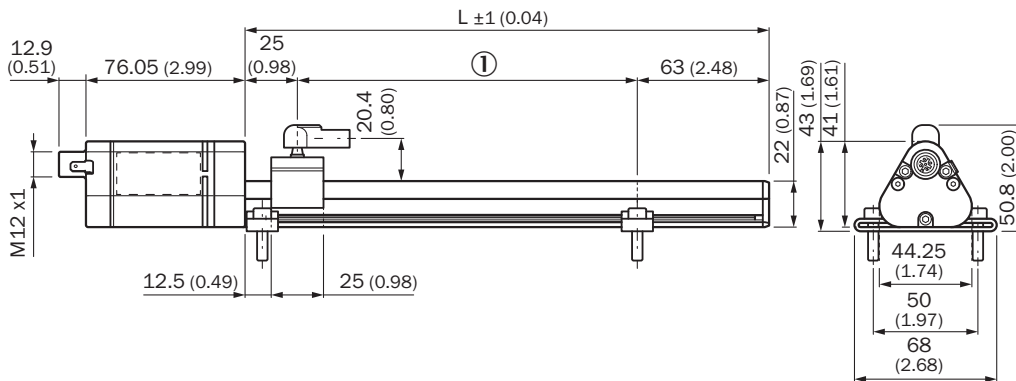

① Measuring range

Slide magnet

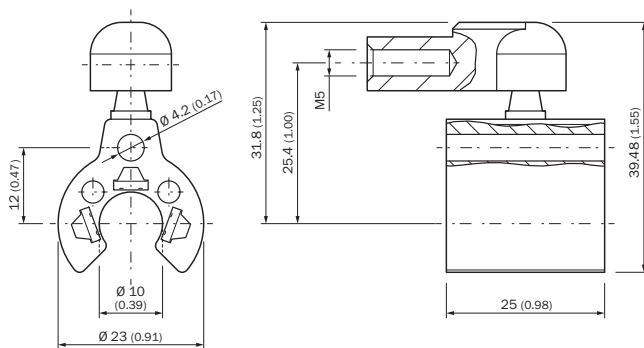



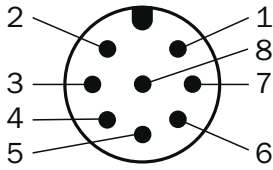

PIN assignment









| M12 male connector, 8-pin | Signal |
|---------------------------|----------------------------------|
| 1 | Output signal ground (0 V PIN 3) |
| 2 | Output signal ground (0 V PIN 5) |
| 3 | Signal 2 |
| 4 | n.c. |
| 5 | Signal 1 |
| 6 | Power Ground |
| 7 | +24 V DC |
| 8 | n.c. |

Recommended accessories

Other models and accessories → www.sick.com/DAX

| | Brief description | Type | Part no. |
|---|--|------------------|----------|
| Magnets | | | |
|  | Slide magnet for magnetostrictive linear encoders | MAG-S-H29-01 | 2129172 |
| Terminal and alignment brackets | | | |
|  | Replacement clamping bracket for DAX® Slider without fastening material, 2 pieces | BEF-KH-SL1-02 | 2125240 |
| | Replacement clamping bracket for DAX® Slider without fastening material, 3 pieces | BEF-KH-SL1-03 | 2125241 |
| | Replacement clamping bracket for DAX® Slider without fastening material, 4 pieces | BEF-KH-SL1-04 | 2125242 |
| Others | | | |
|  | <ul style="list-style-type: none"> Connection type head A: Female connector, M12, 8-pin, straight Connection type head B: Flying leads Signal type: Incremental, SSI Cable: 2 m, 8-wire, PUR, halogen-free Description: Incremental, SSI, shielded, Head A: female connector, M12, 8-pin, straight Head B: cable Cable: suitable for drag chain, PVC, shielded, 4 x 2 x 0.25 mm², Ø 7.0 mm Connection systems: Flying leads | DOL-1208-G02MAC1 | 6032866 |
|  | <ul style="list-style-type: none"> Connection type head A: Female connector, M12, 8-pin, straight Connection type head B: Flying leads Signal type: Incremental, SSI Cable: 5 m, 8-wire, PUR, halogen-free Description: Incremental, SSI, shielded, Head A: female connector, M12, 8-pin, straight Head B: cable Cable: suitable for drag chain, PVC, shielded, 4 x 2 x 0.25 mm², Ø 7.0 mm Connection systems: Flying leads | DOL-1208-G05MAC1 | 6032867 |

| | Brief description | Type | Part no. |
|---|---|------------------|----------|
|  | <ul style="list-style-type: none"> • Connection type head A: Female connector, M12, 8-pin, straight • Connection type head B: Flying leads • Signal type: Incremental, SSI • Cable: 10 m, 8-wire, PUR, halogen-free • Description: Incremental, SSI, shielded, Head A: female connector, M12, 8-pin, straight Head B: cable Cable: suitable for drag chain, PVC, shielded, 4 x 2 x 0.25 mm², Ø 7.0 mm • Connection systems: Flying leads | DOL-1208-G10MAC1 | 6032868 |
|  | <ul style="list-style-type: none"> • Connection type head A: Female connector, M12, 8-pin, straight • Connection type head B: Flying leads • Signal type: Incremental, SSI • Cable: 20 m, 8-wire, PUR, halogen-free • Description: Incremental, SSI, shielded, Head A: female connector, M12, 8-pin, straight Head B: cable Cable: suitable for drag chain, PVC, shielded, 4 x 2 x 0.25 mm², Ø 7.0 mm • Connection systems: Flying leads | DOL-1208-G20MAC1 | 6032869 |
|  | <ul style="list-style-type: none"> • Connection type head A: Female connector, M12, 8-pin, straight • Connection type head B: Flying leads • Signal type: Incremental, SSI • Cable: 25 m, 8-wire, PUR, halogen-free • Description: Incremental, SSI, shielded, Head A: female connector, M12, 8-pin, straight Head B: cable Cable: suitable for drag chain, PVC, shielded, 4 x 2 x 0.25 mm², Ø 7.0 mm • Connection systems: Flying leads | DOL-1208-G25MAC1 | 6067859 |
|  | <ul style="list-style-type: none"> • Connection type head A: Female connector, M12, 8-pin, straight, A-coded • Signal type: Incremental, SSI • Cable: CAT5, CAT5e • Description: Incremental, SSI, shielded, Head A: female connector, M12, 8-pin, straight, A encoded, shielded, for cable diameter 4 mm ... 8 mm Head B: - Operating temperature: -40 °C ... +85 °C • Connection systems: IDC quick connection • Permitted cross-section: 0.14 mm² ... 0.34 mm² | DOS-1208-GA01 | 6045001 |
|  | <ul style="list-style-type: none"> • Connection type head A: Flying leads • Connection type head B: Flying leads • Signal type: SSI, Incremental, HIPERFACE® • Cable: 8-wire, PUR, halogen-free • Description: SSI, Incremental, HIPERFACE®, shielded | LTG-2308-MWENC | 6027529 |
|  | <ul style="list-style-type: none"> • Connection type head A: Flying leads • Connection type head B: Flying leads • Signal type: SSI, TTL, HTL, Incremental • Cable: 12-wire, UV and saltwater-resistant, PUR, halogen-free • Description: SSI, TTL, HTL, Incremental, shielded, Head A: cable Head B: cable Cable: suitable for drag chain, PUR, halogen-free, shielded, UV and saltwater resistant, 4 x 2 x 0.25 mm² + 2 x 0.5 mm² + 2 x 0.14 mm², Ø 7.8 mm | LTG-2612-MW | 6028516 |

SICK AT A GLANCE

SICK is one of the leading manufacturers of intelligent sensors and sensor solutions for industrial applications. A unique range of products and services creates the perfect basis for controlling processes securely and efficiently, protecting individuals from accidents and preventing damage to the environment.

We have extensive experience in a wide range of industries and understand their processes and requirements. With intelligent sensors, we can deliver exactly what our customers need. In application centers in Europe, Asia and North America, system solutions are tested and optimized in accordance with customer specifications. All this makes us a reliable supplier and development partner.

Comprehensive services complete our offering: SICK LifeTime Services provide support throughout the machine life cycle and ensure safety and productivity.

For us, that is “Sensor Intelligence.”

WORLDWIDE PRESENCE:

Contacts and other locations –www.sick.com