



DAXTVN-2500RA1B0400R01

DAX

MAGNETOSTRICTIVE LINEAR ENCODERS

SICK
Sensor Intelligence.



Illustration may differ

Ordering information

Type	Part no.
DAXTVN-2500RA1B0400R01	1130927

Accessories not included with delivery, please order separately.

Delivery without position magnet.

Other models and accessories → www.sick.com/DAX



Detailed technical data

Safety-related parameters

MTTF_D (mean time to dangerous failure)	123 years ¹⁾
--	-------------------------

¹⁾ This product is a standard product and does not constitute a safety component as defined in the Machinery Directive. Calculation based on nominal load of components, average ambient temperature 40 °C, frequency of use 8760 h/a. All electronic failures are considered hazardous. For more information, see document no. 8015532.

Performance

Linearity	≤ 0.02% F.S. (Minimum 60 μm) ^{1) 2)}
Repeatability	≤ ± 20 μm
Measured values	Positioning
Measuring range	0 mm ... 2,500 mm
Unusable range	
Null zone	50 mm
Damping zone	63 mm
Magnet type	
Magnet shape	Ring magnet
Configured for number of magnets	1 piece
Magnet travel speed	Any
Measuring frequency (internal)	< 2 ms

¹⁾ Systematic position measurement deviation according to DIN ISO 1319-1 (value includes all systematic errors or deviations from the actual position value, e.g. repeatability and hysteresis).

²⁾ In principle, the size of the measurement deviation is limited by the resolution of the interface.

Interfaces

Communication interface	Analog
Communication Interface detail	Voltage
Output signal	10 V ... 0 V
Signals	
Number of signals	Two output signals (one output signal + an inverted second output signal)
Sequence of signals	Signal 1: falling, signal 2: rising
Load resistance	> 10 kΩ

Electrical data

Connection type	Male connector, M12, 8-pin
PIN assignment	1=Output signal ground (0 V PIN 3); 2=Output signal ground (0 V PIN 5); 3=Signal 2; 4=n.c.; 5=Signal 1; 6=Power ground; 7=+24 V DC; 8=n.c.
Male connector coding	A-coded
Supply voltage	24 V DC ($\pm 20\%$)
Reverse polarity protection	Up to -30 V DC
Residual ripple	$\leq 0.28 V_{pp}$
Dielectric strength	500 V DC, 0 V against housing
Over voltage protection	≤ 36 V DC
MTTFd: mean time to dangerous failure	123 years ¹⁾

¹⁾ This product is a standard product and does not constitute a safety component as defined in the Machinery Directive. Calculation based on nominal load of components, average ambient temperature 40 °C, frequency of use 8760 h/a. All electronic failures are considered hazardous. For more information, see document no. 8015532.

Mechanical data

Mechanical design	DAX Threaded
Thread	
Thread shape	3/4"-16UNF
Thread offset	With thread offset
Material	
Pressure pipe	Stainless steel 1.4404 (AISI 316L)
Housing	Aluminum (anodised), zinc, stainless steel, brass
Flange	Stainless steel 1.4305 (AISI 303)

Ambient data

EMC	According to EN 61000-6-2 and EN 61000-6-4
Enclosure rating	IP65 / IP67 ¹⁾
Temperature	
Operating temperature range	-40 °C ... $+85$ °C
Storage temperature range	-40 °C ... $+65$ °C ²⁾
Permissible relative humidity	90 % (Condensation not permitted)
Resistance to shocks	100 g, 6 ms (IEC 60068-2-27)
Resistance to vibration	15 g / 10...2,000 Hz according to IEC 60068-2-6
Nominal operating pressure (P_N)	350 bar
Max. overload pressure during operation ($P_N \times 1.2$)	420 bar
Max. test pressure in cylinder ($P_N \times 1.5$)	530 bar

¹⁾ In correctly assembled mating connector.

²⁾ Caused by dry storage of the O-ring in uninstalled state (no coating with oil).

General notes

Items supplied	Accessories not included with delivery, please order separately. Delivery without position magnet.
-----------------------	---

Classifications

ECLASS 5.0	27270705
ECLASS 5.1.4	27270705
ECLASS 6.0	27270705
ECLASS 6.2	27270705
ECLASS 7.0	27270705
ECLASS 8.0	27270705
ECLASS 8.1	27270705
ECLASS 9.0	27270705
ECLASS 10.0	27270705
ECLASS 11.0	27270705
ECLASS 12.0	27274304
ETIM 5.0	EC002544
ETIM 6.0	EC002544
ETIM 7.0	EC002544
ETIM 8.0	EC002544
UNSPSC 16.0901	411111613

Dimensional drawing (Dimensions in mm (inch))

DAX Threaded

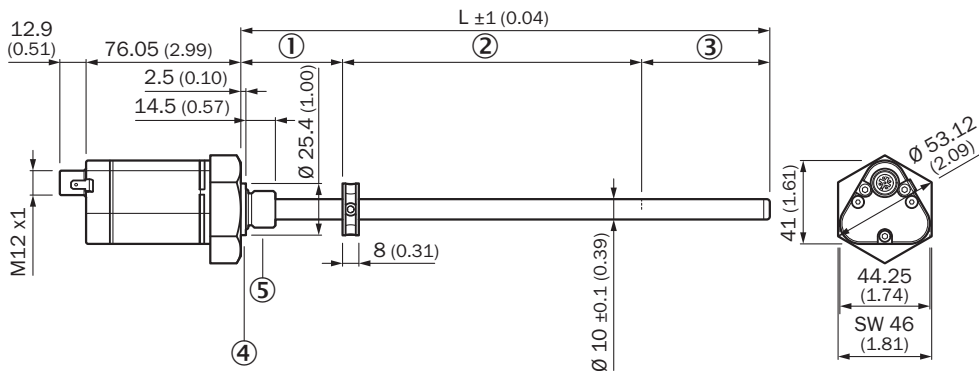

- ① Null zone
- ② Measuring range
- ③ Damping zone
- ④ Offset support surface
- ⑤ M18x1.5 / UNF 3/4"-16

Ring magnet

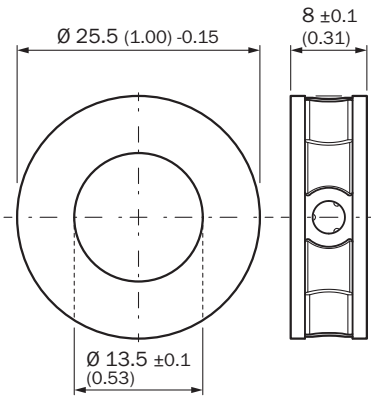

PIN assignment

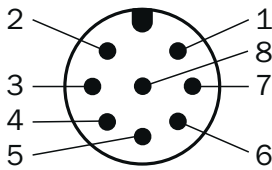









M12 male connector, 8-pin	Signal
1	Output signal ground (0 V PIN 3)
2	Output signal ground (0 V PIN 5)
3	Signal 2
4	n.c.
5	Signal 1
6	Power Ground
7	+24 V DC
8	n.c.

Recommended accessories

Other models and accessories → www.sick.com/DAX

	Brief description	Type	Part no.
Magnets			
	Position magnet for magnetostriptive linear encoder, $\varnothing 25.5 \text{ mm}$ max. axial surface pressures 20 N/mm^2	MAG-O-255-01	2129168

	Brief description	Type	Part no.
Others			
	<ul style="list-style-type: none"> • Connection type head A: Female connector, M12, 8-pin, straight • Connection type head B: Flying leads • Signal type: Incremental, SSI • Cable: 2 m, 8-wire, PUR, halogen-free • Description: Incremental, SSI, shielded, Head A: female connector, M12, 8-pin, straight Head B: cable Cable: suitable for drag chain, PVC, shielded, 4 x 2 x 0.25 mm², Ø 7.0 mm • Connection systems: Flying leads 	DOL-1208-G02MAC1	6032866
	<ul style="list-style-type: none"> • Connection type head A: Female connector, M12, 8-pin, straight • Connection type head B: Flying leads • Signal type: Incremental, SSI • Cable: 5 m, 8-wire, PUR, halogen-free • Description: Incremental, SSI, shielded, Head A: female connector, M12, 8-pin, straight Head B: cable Cable: suitable for drag chain, PVC, shielded, 4 x 2 x 0.25 mm², Ø 7.0 mm • Connection systems: Flying leads 	DOL-1208-G05MAC1	6032867
	<ul style="list-style-type: none"> • Connection type head A: Female connector, M12, 8-pin, straight • Connection type head B: Flying leads • Signal type: Incremental, SSI • Cable: 10 m, 8-wire, PUR, halogen-free • Description: Incremental, SSI, shielded, Head A: female connector, M12, 8-pin, straight Head B: cable Cable: suitable for drag chain, PVC, shielded, 4 x 2 x 0.25 mm², Ø 7.0 mm • Connection systems: Flying leads 	DOL-1208-G10MAC1	6032868
	<ul style="list-style-type: none"> • Connection type head A: Female connector, M12, 8-pin, straight • Connection type head B: Flying leads • Signal type: Incremental, SSI • Cable: 20 m, 8-wire, PUR, halogen-free • Description: Incremental, SSI, shielded, Head A: female connector, M12, 8-pin, straight Head B: cable Cable: suitable for drag chain, PVC, shielded, 4 x 2 x 0.25 mm², Ø 7.0 mm • Connection systems: Flying leads 	DOL-1208-G20MAC1	6032869
	<ul style="list-style-type: none"> • Connection type head A: Female connector, M12, 8-pin, straight • Connection type head B: Flying leads • Signal type: Incremental, SSI • Cable: 25 m, 8-wire, PUR, halogen-free • Description: Incremental, SSI, shielded, Head A: female connector, M12, 8-pin, straight Head B: cable Cable: suitable for drag chain, PVC, shielded, 4 x 2 x 0.25 mm², Ø 7.0 mm • Connection systems: Flying leads 	DOL-1208-G25MAC1	6067859
	<ul style="list-style-type: none"> • Connection type head A: Female connector, M12, 8-pin, straight, A-coded • Signal type: Incremental, SSI • Cable: CAT5, CAT5e • Description: Incremental, SSI, shielded, Head A: female connector, M12, 8-pin, straight, A encoded, shielded, for cable diameter 4 mm ... 8 mm Head B: - Operating temperature: -40 °C ... +85 °C • Connection systems: IDC quick connection • Permitted cross-section: 0.14 mm² ... 0.34 mm² 	DOS-1208-GA01	6045001
	<ul style="list-style-type: none"> • Connection type head A: Flying leads • Connection type head B: Flying leads • Signal type: SSI, Incremental, HIPERFACE® • Cable: 8-wire, PUR, halogen-free • Description: SSI, Incremental, HIPERFACE®, shielded 	LTG-2308-MWENC	6027529
	<ul style="list-style-type: none"> • Connection type head A: Flying leads • Connection type head B: Flying leads • Signal type: SSI, TTL, HTL, Incremental • Cable: 12-wire, UV and saltwater-resistant, PUR, halogen-free • Description: SSI, TTL, HTL, Incremental, shielded, Head A: cable Head B: cable Cable: suitable for drag chain, PUR, halogen-free, shielded, UV and saltwater resistant, 4 x 2 x 0.25 mm² + 2 x 0.5 mm² + 2 x 0.14 mm², Ø 7.8 mm 	LTG-2612-MW	6028516

SICK AT A GLANCE

SICK is one of the leading manufacturers of intelligent sensors and sensor solutions for industrial applications. A unique range of products and services creates the perfect basis for controlling processes securely and efficiently, protecting individuals from accidents and preventing damage to the environment.

We have extensive experience in a wide range of industries and understand their processes and requirements. With intelligent sensors, we can deliver exactly what our customers need. In application centers in Europe, Asia and North America, system solutions are tested and optimized in accordance with customer specifications. All this makes us a reliable supplier and development partner.

Comprehensive services complete our offering: SICK LifeTime Services provide support throughout the machine life cycle and ensure safety and productivity.

For us, that is “Sensor Intelligence.”

WORLDWIDE PRESENCE:

Contacts and other locations –www.sick.com