



DFS25A-A2A12010000

DFS2x

INCREMENTAL ENCODERS

SICK
Sensor Intelligence.

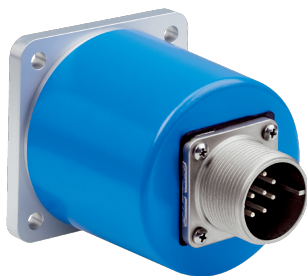

Illustration may differ



Ordering information

Type	Part no.
DFS25A-A2A12010000	1091122

Other models and accessories → www.sick.com/DFS2x

Detailed technical data

Performance

Pulses per revolution	10,000
Measuring step	± 90°, electric/pulses per revolution
Measuring step deviation	± 0.008° pulses 100 ... 10,000
Error limits	± 0.03°

Interfaces

Communication interface	Incremental
Communication Interface detail	TTL / RS-422
Number of signal channels	6-channel
0-set function via hardware pin	✓
0-SET function	H-active, L = 0 - 3 V, H = 4,0 - U _s V
Initialization time	40 ms ¹⁾
Output frequency	820 kHz
Load current	30 mA
Operating current	50 mA (without load)

¹⁾ Valid positional data can be read once this time has elapsed.

Electrical data

Connection type	Male connector, MS, 10-pin, axial
Supply voltage	4.5 ... 5.5 V
Reference signal, number	1
Reference signal, position	180°, electric, gated with A
Reverse polarity protection	✓
Short-circuit protection of the outputs	✓ ¹⁾
MTTFd: mean time to dangerous failure	330 years (EN ISO 13849-1) ²⁾

¹⁾ Short-circuit opposite to another channel or GND permissible for maximum 30 s.

²⁾ This product is a standard product and does not constitute a safety component as defined in the Machinery Directive. Calculation based on nominal load of components, average ambient temperature 40°C, frequency of use 8760 h/a. All electronic failures are considered hazardous. For more information, see document no. 8015532.

Mechanical data

Mechanical design	Solid shaft, Square flange
Shaft diameter	3/8"
Shaft length	19 mm
Weight	+ 0.4 kg ¹⁾
Shaft material	Stainless steel 1,4305
Flange material	Aluminum
Housing material	Aluminum
Start up torque	0.5 Ncm (+20 °C)
Operating torque	0.3 Ncm (+20 °C)
Permissible shaft loading	80 N (radial) 40 N (axial)
Operating speed	≤ 9,000 min ⁻¹
Moment of inertia of the rotor	15 gcm ²
Bearing lifetime	3.6 x 10 ⁹ revolutions
Angular acceleration	≤ 500,000 rad/s ²

¹⁾ Based on encoder with MS male connector.

Ambient data

EMC	According to EN 61000-6-2 and EN 61000-6-3
Enclosure rating	IP65, shaft side (IEC 60529) IP67, housing side (IEC 60529)
Permissible relative humidity	90 % (Condensation not permitted)
Operating temperature range	-30 °C ... +85 °C
Storage temperature range	-40 °C ... +100 °C, without package
Resistance to shocks	100 g, 11 ms (EN 60068-2-27)
Resistance to vibration	30 g, 10 Hz ... 2,000 Hz (EN 60068-2-6)

Classifications

ECLASS 5.0	27270501
ECLASS 5.1.4	27270501
ECLASS 6.0	27270590
ECLASS 6.2	27270590
ECLASS 7.0	27270501
ECLASS 8.0	27270501
ECLASS 8.1	27270501
ECLASS 9.0	27270501
ECLASS 10.0	27270501
ECLASS 11.0	27270501
ECLASS 12.0	27270501
ETIM 5.0	EC001486
ETIM 6.0	EC001486
ETIM 7.0	EC001486

ETIM 8.0	EC001486
UNSPSC 16.0901	41112113

Dimensional drawing (Dimensions in mm (inch))

DFS25 square flange mount, radial connector outlet M12 and MS, cable outlet

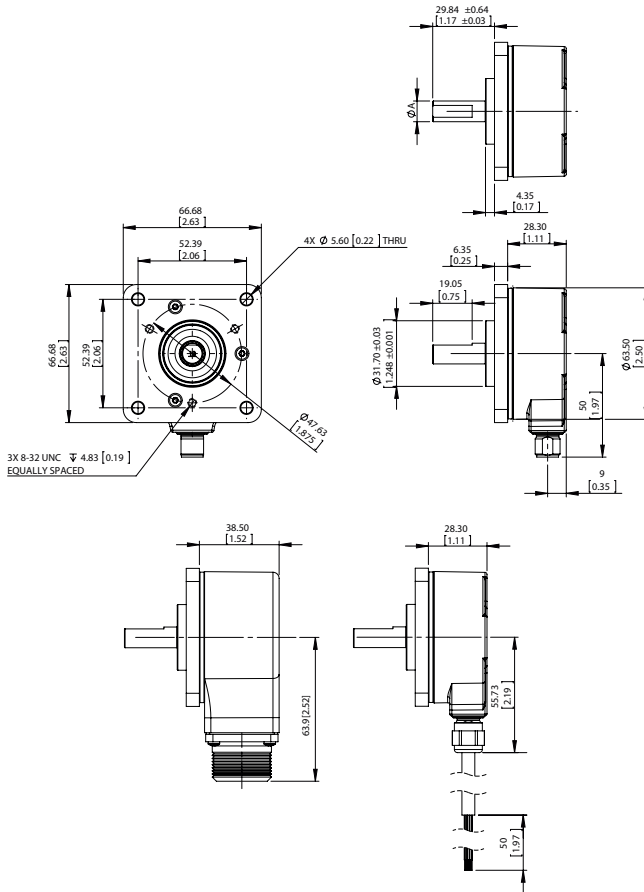

Type	Shaft diameter A
DFS2x-x1xxxxxxx	1/4"
DFS2x-x2xxxxxxx	3/8"
DFS2x-xCxxxxxxx	
DFS2x-xFxxxxxxx	1/2"
DFS2x-x3xxxxxxx	6 mm
DFS2x-x4xxxxxxx	10 mm

Diagrams

Maximum revolution range

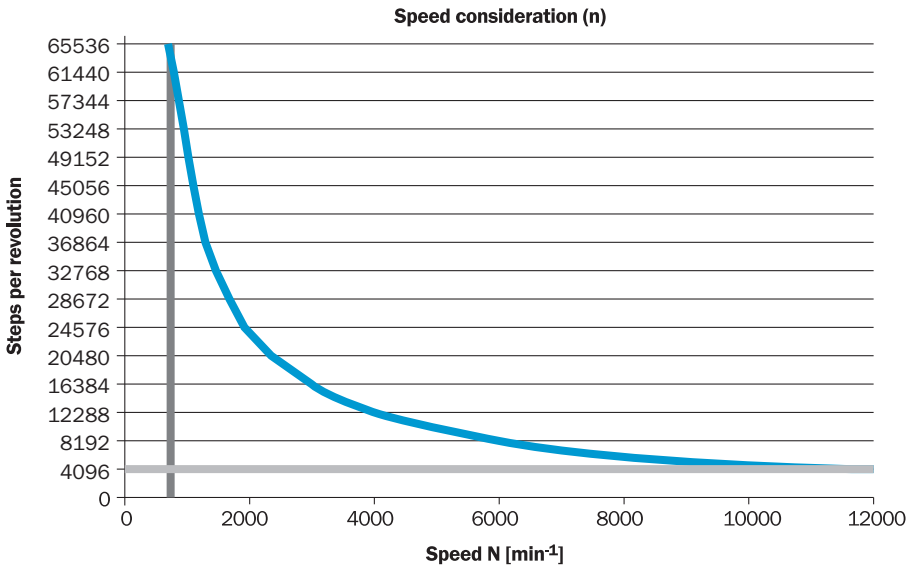

Signal Outputs with Counter Clock-wise Counting Direction Option Selected (B leads A for clock-wise rotation). Complement signals AN, BN and ZN are not shown.

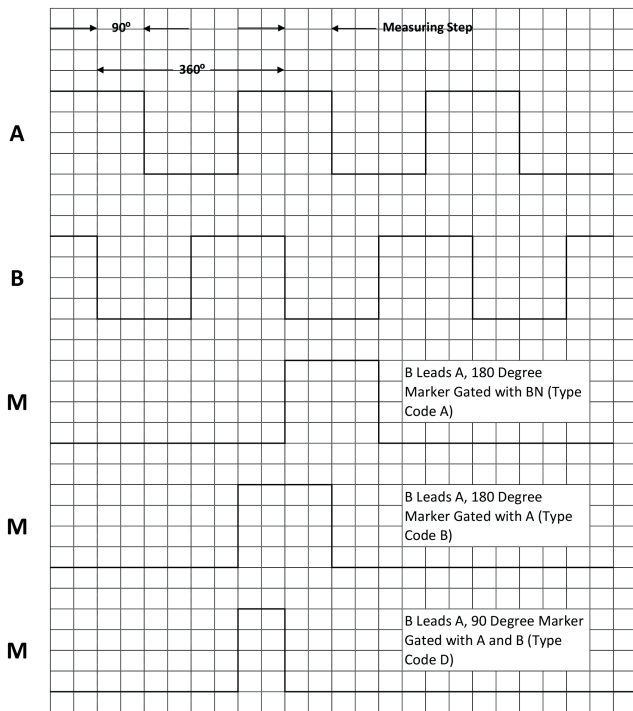

Cw with view on the encoder shaft in direction "A", compare dimensional drawing.





Signal Outputs with Clock-wise Counting Direction Option Selected (A leads B for clock-wise rotation). Complement signals AN, BN and ZN are not shown.





Cw with view on the encoder shaft in direction "A", compare dimensional drawing.

Recommended accessories

Other models and accessories → www.sick.com/DFS2x

	Brief description	Type	Part no.
Others			
	<ul style="list-style-type: none"> Connection type head A: Female connector, MS/10, 10-pin, straight Connection type head B: Flying leads Cable: 3 m, 11-wire Description: Shielded 	DOL-MS10-G03MMA2	7102131
	<ul style="list-style-type: none"> Connection type head A: Female connector, MS/10, 10-pin, straight Connection type head B: Flying leads Cable: 5 m, 11-wire Description: Shielded 	DOL-MS10-G05MMA2	7102132
	<ul style="list-style-type: none"> Connection type head A: Female connector, MS/10, 10-pin, straight Connection type head B: Flying leads Cable: 1.5 m, 11-wire Description: Shielded 	DOL-MS10-G1M5MA2	7102130
	<ul style="list-style-type: none"> Connection type head A: Female connector, MS/10, 10-pin, straight Connection type head B: Flying leads Cable: 10 m, 11-wire Description: Shielded 	DOL-MS10-G10MMA2	7102133
	<ul style="list-style-type: none"> Connection type head A: Female connector, MS/10, 10-pin, straight Connection type head B: Flying leads Cable: 20 m, 11-wire Description: Shielded 	DOL-MS10-G20MMA2	7102134

	Brief description	Type	Part no.
	<ul style="list-style-type: none">• Connection type head A: Female connector, MS/10, 10-pin, straight• Connection type head B: Flying leads• Cable: 30 m, 11-wire• Description: Shielded	DOL-MS10-G30MMA2	7102135
	<ul style="list-style-type: none">• Connection type head A: Female connector, MS/10, 10-pin, straight, A-coded• Description: Unshielded	DOS-MS10-G	7102129

SICK AT A GLANCE

SICK is one of the leading manufacturers of intelligent sensors and sensor solutions for industrial applications. A unique range of products and services creates the perfect basis for controlling processes securely and efficiently, protecting individuals from accidents and preventing damage to the environment.

We have extensive experience in a wide range of industries and understand their processes and requirements. With intelligent sensors, we can deliver exactly what our customers need. In application centers in Europe, Asia and North America, system solutions are tested and optimized in accordance with customer specifications. All this makes us a reliable supplier and development partner.

Comprehensive services complete our offering: SICK LifeTime Services provide support throughout the machine life cycle and ensure safety and productivity.

For us, that is “Sensor Intelligence.”

WORLDWIDE PRESENCE:

Contacts and other locations –www.sick.com