



# DFS25A-A2BAD002500

DFS2x

INCREMENTAL ENCODERS

**SICK**  
Sensor Intelligence.



Illustration may differ



### Ordering information

Type	Part no.
DFS25A-A2BAD002500	1092265

Other models and accessories → [www.sick.com/DFS2x](http://www.sick.com/DFS2x)

### Detailed technical data

#### Performance

<b>Pulses per revolution</b>	2,500
<b>Measuring step</b>	± 90°, electric/pulses per revolution
<b>Measuring step deviation</b>	± 0.008° pulses 100 ... 10,000
<b>Error limits</b>	± 0.03°

#### Interfaces

<b>Communication interface</b>	Incremental
<b>Communication Interface detail</b>	HTL / Push pull
<b>Number of signal channels</b>	6-channel
<b>0-set function via hardware pin</b>	✓
<b>0-SET function</b>	H-active, L = 0 - 3 V, H = 4,0 - U <sub>s</sub> V
<b>Initialization time</b>	40 ms <sup>1)</sup>
<b>Output frequency</b>	820 kHz
<b>Load current</b>	30 mA
<b>Power consumption</b>	0.7 W (without load)

<sup>1)</sup> Valid positional data can be read once this time has elapsed.

#### Electrical data

<b>Connection type</b>	Male connector, MS, 10-pin, radial
<b>Supply voltage</b>	8 ... 30 V
<b>Reference signal, number</b>	1
<b>Reference signal, position</b>	180°, Degree Marker Gated with BN2
<b>Reverse polarity protection</b>	✓
<b>Short-circuit protection of the outputs</b>	✓ <sup>1)</sup>

<sup>1)</sup> Short-circuit opposite to another channel or GND permissible for maximum 30 s.

<sup>2)</sup> This product is a standard product and does not constitute a safety component as defined in the Machinery Directive. Calculation based on nominal load of components, average ambient temperature 40°C, frequency of use 8760 h/a. All electronic failures are considered hazardous. For more information, see document no. 8015532.

<b>MTTFd: mean time to dangerous failure</b>	330 years (EN ISO 13849-1) <sup>2)</sup>
--	--

<sup>1)</sup> Short-circuit opposite to another channel or GND permissible for maximum 30 s.

<sup>2)</sup> This product is a standard product and does not constitute a safety component as defined in the Machinery Directive. Calculation based on nominal load of components, average ambient temperature 40 °C, frequency of use 8760 h/a. All electronic failures are considered hazardous. For more information, see document no. 8015532.

## Mechanical data

<b>Mechanical design</b>	Solid shaft, Square flange
<b>Shaft diameter</b>	3/8"
<b>Shaft length</b>	19 mm
<b>Weight</b>	+ 0.4 kg <sup>1)</sup>
<b>Shaft material</b>	Stainless steel 1,4305
<b>Flange material</b>	Aluminum
<b>Housing material</b>	Aluminum
<b>Start up torque</b>	0.5 Ncm (+20 °C)
<b>Operating torque</b>	0.3 Ncm (+20 °C)
<b>Permissible shaft loading</b>	80 N (radial) 40 N (axial)
<b>Operating speed</b>	≤ 9,000 min <sup>-1</sup>
<b>Moment of inertia of the rotor</b>	15 gcm <sup>2</sup>
<b>Bearing lifetime</b>	3.6 x 10 <sup>9</sup> revolutions
<b>Angular acceleration</b>	≤ 500,000 rad/s <sup>2</sup>

<sup>1)</sup> Based on encoder with MS male connector.

## Ambient data

<b>EMC</b>	According to EN 61000-6-2 and EN 61000-6-3
<b>Enclosure rating</b>	IP65, shaft side (IEC 60529) IP67, housing side (IEC 60529)
<b>Permissible relative humidity</b>	90 % (Condensation not permitted)
<b>Operating temperature range</b>	-30 °C ... +85 °C
<b>Storage temperature range</b>	-40 °C ... +100 °C, without package
<b>Resistance to shocks</b>	100 g, 11 ms (EN 60068-2-27)
<b>Resistance to vibration</b>	30 g, 10 Hz ... 2,000 Hz (EN 60068-2-6)

## Classifications

<b>ECLASS 5.0</b>	27270501
<b>ECLASS 5.1.4</b>	27270501
<b>ECLASS 6.0</b>	27270590
<b>ECLASS 6.2</b>	27270590
<b>ECLASS 7.0</b>	27270501
<b>ECLASS 8.0</b>	27270501
<b>ECLASS 8.1</b>	27270501
<b>ECLASS 9.0</b>	27270501
<b>ECLASS 10.0</b>	27270501
<b>ECLASS 11.0</b>	27270501

<b>ECLASS 12.0</b>	27270501
<b>ETIM 5.0</b>	EC001486
<b>ETIM 6.0</b>	EC001486
<b>ETIM 7.0</b>	EC001486
<b>ETIM 8.0</b>	EC001486
<b>UNSPSC 16.0901</b>	41112113

### Dimensional drawing (Dimensions in mm (inch))

DFS25 square flange mount, radial connector outlet M12 and MS, cable outlet

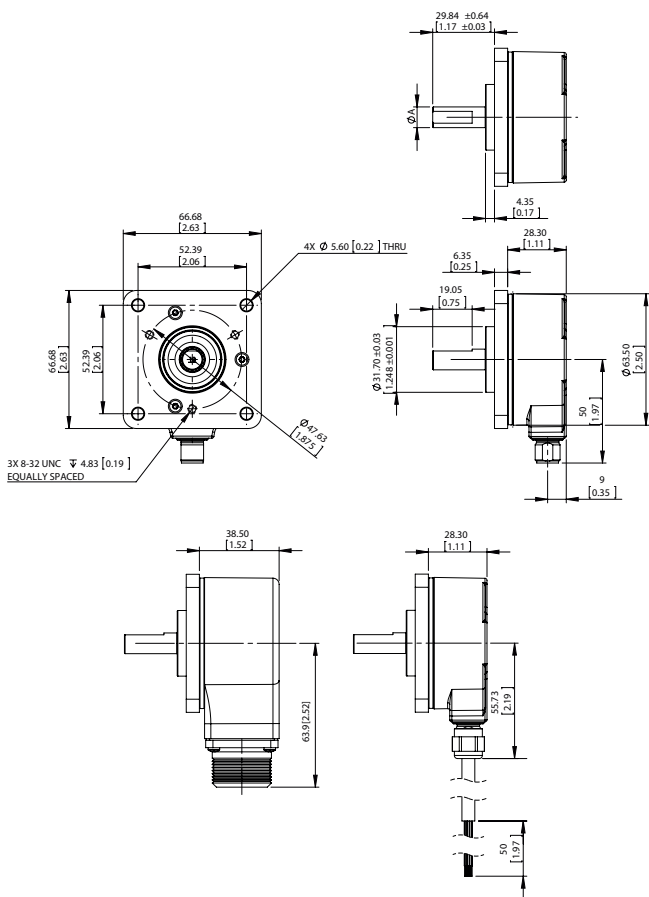

Type	Shaft diameter A
DFS2x-x1xxxxxxxx	1/4"
DFS2x-x2xxxxxxxx DFS2x-xCxxxxxxxx	3/8"
DFS2x-xFxxxxxxxx	1/2"
DFS2x-x3xxxxxxxx	6 mm
DFS2x-x4xxxxxxxx	10 mm

## Diagrams

Maximum revolution range



Signal Outputs with Counter Clock-wise Counting Direction Option Selected (B leads A for clock-wise rotation). Complement signals AN, BN and ZN are not shown.

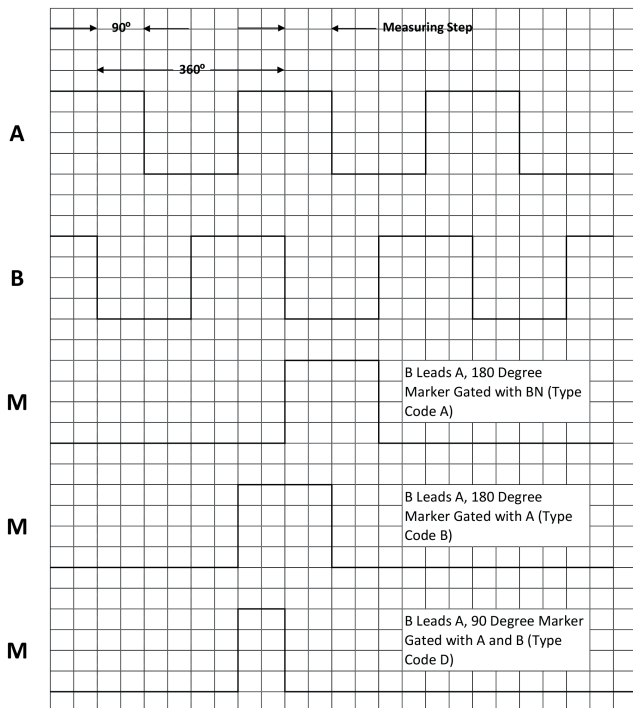

Cw with view on the encoder shaft in direction "A", compare dimensional drawing.

Signal Outputs with Clock-wise Counting Direction Option Selected (A leads B for clock-wise rotation). Complement signals AN, BN and ZN are not shown.



Cw with view on the encoder shaft in direction "A", compare dimensional drawing.

### Recommended accessories

Other models and accessories → [www.sick.com/DFS2x](http://www.sick.com/DFS2x)

	Brief description	Type	Part no.
Others			
	<ul style="list-style-type: none"> <li><b>Connection type head A:</b> Female connector, MS/10, 10-pin, straight</li> <li><b>Connection type head B:</b> Flying leads</li> <li><b>Cable:</b> 3 m, 11-wire</li> <li><b>Description:</b> Shielded</li> </ul>	DOL-MS10-G03MMA2	7102131
	<ul style="list-style-type: none"> <li><b>Connection type head A:</b> Female connector, MS/10, 10-pin, straight</li> <li><b>Connection type head B:</b> Flying leads</li> <li><b>Cable:</b> 5 m, 11-wire</li> <li><b>Description:</b> Shielded</li> </ul>	DOL-MS10-G05MMA2	7102132
	<ul style="list-style-type: none"> <li><b>Connection type head A:</b> Female connector, MS/10, 10-pin, straight</li> <li><b>Connection type head B:</b> Flying leads</li> <li><b>Cable:</b> 1.5 m, 11-wire</li> <li><b>Description:</b> Shielded</li> </ul>	DOL-MS10-G1M5MA2	7102130
	<ul style="list-style-type: none"> <li><b>Connection type head A:</b> Female connector, MS/10, 10-pin, straight</li> <li><b>Connection type head B:</b> Flying leads</li> <li><b>Cable:</b> 10 m, 11-wire</li> <li><b>Description:</b> Shielded</li> </ul>	DOL-MS10-G10MMA2	7102133
	<ul style="list-style-type: none"> <li><b>Connection type head A:</b> Female connector, MS/10, 10-pin, straight</li> <li><b>Connection type head B:</b> Flying leads</li> <li><b>Cable:</b> 20 m, 11-wire</li> <li><b>Description:</b> Shielded</li> </ul>	DOL-MS10-G20MMA2	7102134

	Brief description	Type	Part no.
	<ul style="list-style-type: none"><li>• <b>Connection type head A:</b> Female connector, MS/10, 10-pin, straight</li><li>• <b>Connection type head B:</b> Flying leads</li><li>• <b>Cable:</b> 30 m, 11-wire</li><li>• <b>Description:</b> Shielded</li></ul>	DOL-MS10-G30MMA2	7102135
	<ul style="list-style-type: none"><li>• <b>Connection type head A:</b> Female connector, MS/10, 10-pin, straight, A-coded</li><li>• <b>Description:</b> Unshielded</li></ul>	DOS-MS10-G	7102129

## SICK AT A GLANCE

SICK is one of the leading manufacturers of intelligent sensors and sensor solutions for industrial applications. A unique range of products and services creates the perfect basis for controlling processes securely and efficiently, protecting individuals from accidents and preventing damage to the environment.

We have extensive experience in a wide range of industries and understand their processes and requirements. With intelligent sensors, we can deliver exactly what our customers need. In application centers in Europe, Asia and North America, system solutions are tested and optimized in accordance with customer specifications. All this makes us a reliable supplier and development partner.

Comprehensive services complete our offering: SICK LifeTime Services provide support throughout the machine life cycle and ensure safety and productivity.

For us, that is “Sensor Intelligence.”

## WORLDWIDE PRESENCE:

Contacts and other locations –[www.sick.com](http://www.sick.com)