



DFS60E-S4EA00720

DFS60

INCREMENTAL ENCODERS

SICK
Sensor Intelligence.

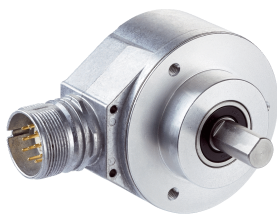

Illustration may differ



Ordering information

Type	Part no.
DFS60E-S4EA00720	1054132

Other models and accessories → www.sick.com/DFS60

Detailed technical data

Safety-related parameters

MTTF_D (mean time to dangerous failure)	300 years (EN ISO 13849-1) ¹⁾
--	--

¹⁾ This product is a standard product and does not constitute a safety component as defined in the Machinery Directive. Calculation based on nominal load of components, average ambient temperature 40 °C, frequency of use 8760 h/a. All electronic failures are considered hazardous. For more information, see document no. 8015532.

Performance

Pulses per revolution	720 ¹⁾
Measuring step	90°, electric/pulses per revolution
Measuring step deviation at non binary number of lines	± 0.2°
Error limits	± 0.3°

¹⁾ See maximum revolution range.

Interfaces

Communication interface	Incremental
Communication Interface detail	HTL / Push pull
Number of signal channels	6-channel
Initialization time	40 ms
Output frequency	≤ 300 kHz
Load current	≤ 30 mA
Power consumption	≤ 0.5 W (without load)

Electronics

Connection type	Male connector, M23, 12-pin, radial
Supply voltage	10 ... 32 V
Reference signal, number	1
Reference signal, position	90°, electric, logically gated with A and B
Reverse polarity protection	✓
Short-circuit protection of the outputs	✓ ¹⁾

¹⁾ Short-circuit opposite to another channel, US or GND permissible for maximum 30 s.

Mechanics

Mechanical design	Solid shaft, face mount flange
Shaft diameter	10 mm With face
Shaft length	19 mm
Weight	+ 0.3 kg
Shaft material	Stainless steel
Flange material	Aluminum
Housing material	Aluminum die cast
Start up torque	0.5 Ncm (+20 °C)
Operating torque	0.3 Ncm (+20 °C)
Permissible shaft loading	80 N (radial) 40 N (axial)
Operating speed	≤ 9,000 min ⁻¹ ¹⁾
Moment of inertia of the rotor	6.2 gcm ²
Bearing lifetime	3.6 x 10 ¹⁰ revolutions
Angular acceleration	≤ 500,000 rad/s ²

¹⁾ Allow for self-heating of 3.3 K per 1,000 rpm when designing the operating temperature range.

Ambient data

EMC	According to EN 61000-6-2 and EN 61000-6-4
Enclosure rating	IP67, Housing side, male connector (IEC 60529) ¹⁾ IP65, shaft side (IEC 60529)
Permissible relative humidity	90 % (Condensation not permitted)
Operating temperature range	0 °C ... +85 °C
Storage temperature range	-40 °C ... +100 °C, without package
Resistance to shocks	50 g, 6 ms (EN 60068-2-27)
Resistance to vibration	20 g, 10 Hz ... 2,000 Hz (EN 60068-2-6)

¹⁾ With mating connector fitted.

Classifications

ECLASS 5.0	27270501
ECLASS 5.1.4	27270501
ECLASS 6.0	27270590
ECLASS 6.2	27270590
ECLASS 7.0	27270501
ECLASS 8.0	27270501
ECLASS 8.1	27270501
ECLASS 9.0	27270501
ECLASS 10.0	27270501
ECLASS 11.0	27270501
ECLASS 12.0	27270501
ETIM 5.0	EC001486

ETIM 6.0	EC001486
ETIM 7.0	EC001486
ETIM 8.0	EC001486
UNSPSC 16.0901	41112113

Dimensional drawing (Dimensions in mm (inch))

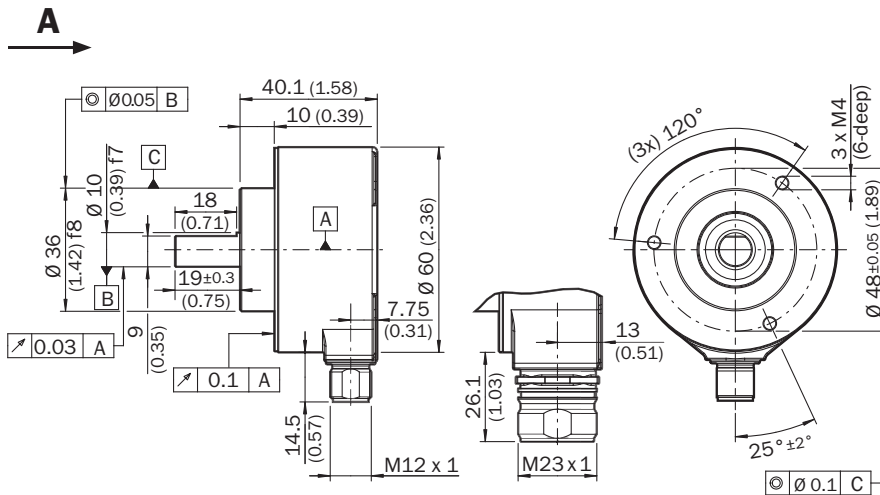

PIN assignment

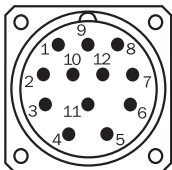

View of M23 male device connector on encoder

PIN Male connector M12, 8-pin	PIN Male connector M23, 12-pin	Wire colors (cable connection)	TTL/HTL signal	Sin/Cos 1.0 V _{PP}	Explanation
1	6	Brown	\bar{A}	COS-	Signal wire
2	5	White	A	COS+	Signal wire
3	1	Black	\bar{B}	SIN-	Signal wire
4	8	Pink	B	SIN+	Signal wire
5	4	Yellow	\bar{Z}	\bar{Z}	Signal wire
6	3	Purple	Z	Z	Signal wire
7	10	Blue	GND	GND	Ground connection
8	12	Red	+U _S	+U _S	Supply voltage
-	9	-	N.c.	N.c.	Not assigned
-	2	-	N.c.	N.c.	Not assigned
-	11	-	N.c.	N.c.	Not assigned

PIN Male connector M12, 8-pin	PIN Male connector M23, 12-pin	Wire colors (cable connection)	TTL/HTL signal	Sin/Cos 1.0 V _{pp}	Explanation
-	7 ¹⁾	Orange	0-SET ¹⁾	N.c.	Set zero pulse ¹⁾
Screen	Screen	Screen	Screen	Screen	Screen connected to housing on encoder side. Connected to ground on control side.

1)

For electrical interfaces only: M, U, V, W with 0-SET function on PIN 7 on M23 plug. The 0-SET input is used to set the zero pulse to the current shaft position. If the 0-SET input is applied to US for longer than 250 ms after it has previously been open or applied to GND for at least 1,000 ms, the current shaft position is assigned zero pulse signal "Z".

Diagrams

Signal outputs

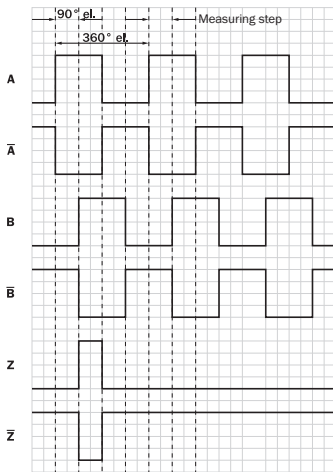

CW with view on the encoder shaft in direction "A", compare dimensional drawing. Maximum revolution range

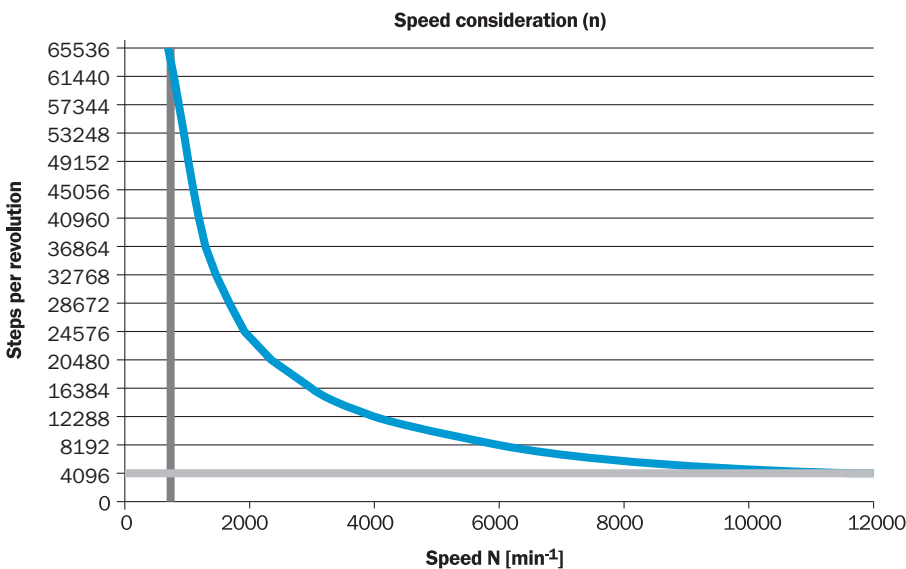













Supply voltage	Output
4,5 V ... 5,5 V	TTL
10 V ... 32 V	TTL
10 V ... 32 V	HTL









Recommended accessories







Other models and accessories → www.sick.com/DFS60

	Brief description	Type	Part no.
Flanges			
	<ul style="list-style-type: none"> Description: Flange adapter, adaptation of face mount flange with 36 mm centering hub to 50 mm servo flange, aluminum, including 3 flat head screws M4 x 10 Material: Aluminum Details: Aluminum Items supplied: Including 3 countersunk screws M3 x 10 	BEF-FA-036-050	2029160
	<ul style="list-style-type: none"> Description: Flange adapter, adaptation of face mount flange with 36 mm centering hub to 60 mm square mounting plate, aluminum, including 3 flat head screws M4 x 8 Material: Aluminum Details: Aluminum Items supplied: Including 3 countersunk screws M4 x 8 	BEF-FA-036-060REC	2029162
	<ul style="list-style-type: none"> Description: Flange adapter, adaptation of face mount flange with 36 mm centering hub to 58 mm square mounting plate with shock absorbers, aluminum Material: Aluminum Details: Aluminum 	BEF-FA-036-060RSA	2029163
	<ul style="list-style-type: none"> Description: Flange adapter, adaptation of face mount flange with 36 mm centering hub to 63 mm square mounting plate, aluminum, including 3 flat head screws M4 x 10 Material: Aluminum Details: Aluminum Items supplied: Including 3 countersunk screws M3 x 10 	BEF-FA-036-063REC	2034225
	<ul style="list-style-type: none"> Description: Flange adapter, adaptation of face mount flange with 36 mm centering hub to 100 mm servo flange with 60 mm centering hub, aluminum Material: Aluminum Details: Aluminum 	BEF-FA-036-100	2029161
Mounting brackets and plates			
	<ul style="list-style-type: none"> Description: Mounting bracket for encoder with spigot 36 mm for face mount flange Items supplied: Mounting kit included 	BEF-WF-36	2029164
	<ul style="list-style-type: none"> Description: Mounting angle spring-loaded, for flange with centerring collar 36 mm, working temperature range -40° ... +120° C Details: Aluminum 	BEF-WF36F	4084775
Other mounting accessories			
	<ul style="list-style-type: none"> Description: Aluminium measuring wheel with O-ring (NBR70) for 10 mm solid shaft, circumference 200 mm 	BEF-MR010020R	2055224
	<ul style="list-style-type: none"> Description: Aluminium measuring wheel with O-ring (NBR70) for 10 mm solid shaft, circumference 300 mm 	BEF-MR010030R	2049278
	<ul style="list-style-type: none"> Description: Measuring wheel with O-ring (NBR70) for 10 mm solid shaft, circumference 500 mm 	BEF-MR010050R	2055227

	Brief description	Type	Part no.
	<ul style="list-style-type: none"> Description: Aluminum measuring wheel with studded polyurethane surface for 6 mm solid shaft, circumference 200 mm 	BEF-MR06200APN	4084747
	<ul style="list-style-type: none"> Description: Aluminum measuring wheel with cross-knurled surface for 10 mm solid shaft, circumference 200 mm 	BEF-MR10200AK	4084737
	<ul style="list-style-type: none"> Description: Aluminum measuring wheel with smooth polyurethane surface for 10 mm solid shaft, circumference 200 mm 	BEF-MR10200AP	4084738
	<ul style="list-style-type: none"> Description: Aluminum measuring wheel with studded polyurethane surface for 10 mm solid shaft, circumference 200 mm 	BEF-MR10200APN	4084739
	<ul style="list-style-type: none"> Description: Aluminum measuring wheel with cross-knurled surface for 10 mm solid shaft, circumference 500 mm 	BEF-MR10500AK	4084733
	<ul style="list-style-type: none"> Description: Aluminum measuring wheel with smooth polyurethane surface for 10 mm solid shaft, circumference 500 mm 	BEF-MR10500AP	4084734
	<ul style="list-style-type: none"> Description: Aluminum measuring wheel with ridged polyurethane surface for 10 mm solid shaft, circumference 500 mm 	BEF-MR10500APG	4084736
	<ul style="list-style-type: none"> Description: Aluminum measuring wheel with studded polyurethane surface for 10 mm solid shaft, circumference 500 mm 	BEF-MR10500APN	4084735
	<ul style="list-style-type: none"> Description: SICK modular measuring wheel system for face mount flange encoder with S4 mechanical design (10 mm x 19 mm solid shaft), e.g., DFS60-S4: with O-ring measuring wheel, circumference 200 mm Suitable for: Face mount flange encoder DFS60, DBS60, AFM60, AFS60, mechanical design S4 (solid shaft 10 mm x 19 mm) 	BEF-MRS-10-U	2085714
	<ul style="list-style-type: none"> Description: Flange adapter (adapts size 60 face mount flange encoder to bearing block with part. no. 2044591) 	BEF-FA-036-050-019	2063378
	<ul style="list-style-type: none"> Description: Bearing block for servo and face mount flange encoder. The heavy-duty bearing block is used to absorb very large radial and axial shaft loads. Particularly when using belt pulleys, chain sprockets, friction wheels. Operating speed max. 4,000 rpm^-1, axial shaft load 150 N, radial shaft load 250 N, bearing service life 3.6 x 10^9 revolutions 	BEF-FA-LB1210	2044591
Shaft adaptation			
	<ul style="list-style-type: none"> Description: Bellows coupling, shaft diameter 6 mm / 10 mm, maximum shaft offset: radial ± 0.25 mm, axial ± 0.4 mm, angular +/- 4°; max. speed 10,000 rpm, -30 °C to +120 °C, max. torque 120 Ncm; material: stainless steel bellows, aluminum hub 	KUP-0610-B	5312982
	<ul style="list-style-type: none"> Description: Double loop coupling, shaft diameter 6 mm / 10 mm, max. shaft offset: radially +/- 2,5 mm, axially +/-3 mm, angle +/- 10 degrees;max. speed 3.000 rpm, -30 to +80 degrees Celsius, torsional spring stiffness of 25 Nm/rad 	KUP-0610-D	5326697
	<ul style="list-style-type: none"> Description: Spring washer coupling, shaft diameter 6 mm / 10 mm, Maximum shaft offset: radial +/- 0.3 mm, axial +/- 0.4 mm, angular +/- 2.5°; max. speed 12,000 rpm, -10° to +80 °C, max. torque 60 Ncm; material: aluminum flange, glass fiber-reinforced polyamide membrane and hardened steel coupling pin 	KUP-0610-F	5312985
	<ul style="list-style-type: none"> Description: Claw coupling, shaft diameter 6 mm / 10 mm, damping element 80 shore blue, maximum shaft offset: radial ± 0.22 mm, axial ± 1 mm angular ± 1.3°, max. speed 19,000 rpm, angle of twist max. 10°, -30 °C to +80 °C, max. torque 800 Ncm, tightening torque of screws: ISO 4029 150 Ncm, material: aluminum flange, damping element: polyurethane 	KUP-0610-J	2127056

	Brief description	Type	Part no.
	<ul style="list-style-type: none"> Description: Bar coupling, shaft diameter 6 mm / 10 mm, max. shaft offset: radial $\pm 0,3$ mm, axial $\pm 0,3$ mm, angular $\pm 3^\circ$; max. speed 10.000 rpm, -10° to $+80^\circ$ C, max. torque: 80 Ncm, material: fiber-glass reinforced polyamide, aluminum hub 	KUP-0610-S	2056407
	<ul style="list-style-type: none"> Description: Double loop coupling, shaft diameter 8 mm / 10 mm, max. shaft offset: radially $\pm 0,25$ mm, axially $\pm 0,4$ mm, angle ± 4 degrees; max. speed 10.000 rpm, -30 to $+120$ degrees Celsius, torsional spring stiffness of 150 Nm/rad 	KUP-0810-D	5326704
	<ul style="list-style-type: none"> Description: Claw coupling, shaft diameter 8 mm / 10 mm, damping element 80 shore blue, maximum shaft offset: radial $\pm 0,22$ mm, axial ± 1 mm angular $\pm 1,3^\circ$, max. speed 19,000 rpm, angle of twist max. 10°, -30° C to $+80^\circ$ C, max. torque 800 Ncm, tightening torque of screws: ISO 4029 150 Ncm, material: aluminum flange, damping element: polyurethane 	KUP-0810-J	2128267
	<ul style="list-style-type: none"> Description: Bar coupling, shaft diameter 8 mm / 10 mm, max. shaft offset: radial $\pm 0,3$ mm, axial $\pm 0,3$ mm, angular $\pm 3^\circ$; max. speed 10.000 rpm, -10° to $+80^\circ$ C, max. torque: 80 Ncm, material: fiber-glass reinforced polyamide, aluminum hub 	KUP-0810-S	5314178
	<ul style="list-style-type: none"> Description: Bellows coupling, shaft diameter 10 mm/10 mm; maximum shaft offset: radial $\pm 0,25$ mm, axial $\pm 0,4$ mm, angular $\pm 4^\circ$; max. revolutions 10,000 rpm, -30° to $+120^\circ$ C, max. torque 120 Ncm; material: stainless steel bellows, aluminum clamping hubs 	KUP-1010-B	5312983
	<ul style="list-style-type: none"> Description: Double loop coupling, shaft diameter 10 mm / 10 mm, Maximum shaft offset: radial $\pm 2,5$ mm, axial ± 3 mm, angular $\pm 10^\circ$; max. speed 3,000 rpm, -30° to $+80^\circ$ C, max. torque 1.5 Nm; material: polyurethane, galvanized steel flange 	KUP-1010-D	5326703
	<ul style="list-style-type: none"> Description: Spring washer coupling, shaft diameter 10 mm / 10 mm, maximum shaft offset, radial $\pm 0,3$ mm, axial $\pm 0,4$ mm, angle $\pm 2,5^\circ$, torsion spring stiffness 30 Nm/rad; material: aluminum flange, glass-fiber reinforced polyamide membrane and hardened steel coupling pin 	KUP-1010-F	5312986
	<ul style="list-style-type: none"> Description: Claw coupling, shaft diameter 10 mm / 10 mm, damping element 80 shore blue, maximum shaft offset: radial $\pm 0,22$ mm, axial ± 1 mm angular $\pm 1,3^\circ$, max. speed 19,000 rpm, angle of twist max. 10°, -30° C to $+80^\circ$ C, max. torque 800 Ncm, tightening torque of screws: ISO 4029 150 Ncm, material: aluminum flange, damping element: polyurethane 	KUP-1010-J	2127054
	<ul style="list-style-type: none"> Description: Bar coupling, shaft diameter 10 mm / 10 mm; maximum shaft offset: radial $\pm 0,3$ mm, axial $\pm 0,2$ mm, angular $\pm 3^\circ$; speed 10,000 rpm, -10° to $+80^\circ$ Celsius, max. torque 80 Ncm; material: glass fiber-reinforced polyamide, aluminum hub 	KUP-1010-S	2056408
	<ul style="list-style-type: none"> Description: 10 mm / 12 mm; maximum shaft offset: radial $\pm 0,25$ mm, axial $\pm 0,4$ mm, angular $\pm 4^\circ$; max. revolutions 10,000 rpm, -30° to $+120^\circ$ C, max. torque 120 Ncm; material: stainless steel bellows, aluminum clamping hubs 	KUP-1012-B	5312984
	<ul style="list-style-type: none"> Description: Double loop coupling, shaft diameter 10 mm / 12 mm, Maximum shaft offset: radial $\pm 2,5$ mm, axial ± 3 mm, angular $\pm 10^\circ$; max. speed 3,000 rpm, -30° to $+80^\circ$ C, max. torque 1.5 Nm; material: polyurethane, galvanized steel flange 	KUP-1012-D	5326702
	<ul style="list-style-type: none"> Description: Claw coupling, shaft diameter 10 mm / 12 mm, damping element 80 shore blue, maximum shaft offset: radial $\pm 0,22$ mm, axial ± 1 mm angular $\pm 1,3^\circ$, max. speed 19,000 rpm, angle of twist max. 10°, -30° C to $+80^\circ$ C, max. torque 800 Ncm, tightening torque of screws: ISO 4029 150 Ncm, material: aluminum flange, damping element: polyurethane 	KUP-1012-J	2128265
Others			
	<ul style="list-style-type: none"> Connection type head A: Female connector, M23, 12-pin, straight Connection type head B: Flying leads Signal type: Incremental Cable: 2 m, 11-wire, PUR Description: Incremental, shielded, Head A: female connector, M23, 12-pin, straight Head B: cable Cable: incremental, PUR, shielded, $4 \times 2 \times 0,25 \text{ mm}^2 + 2 \times 0,5 \text{ mm}^2 + 1 \times 0,14 \text{ mm}^2$, $\varnothing 7,8$ mm 	DOL-2312-G02MLA3	2030682

	Brief description	Type	Part no.
	<ul style="list-style-type: none"> • Connection type head A: Female connector, M23, 12-pin, straight • Connection type head B: Flying leads • Signal type: Incremental • Cable: 7 m, 11-wire, PUR • Description: Incremental, shielded, Head A: female connector, M23, 12-pin, straight Head B: cable Cable: incremental, PUR, shielded, 4 x 2 x 0.25 mm² + 2 x 0.5 mm² + 1 x 0.14 mm², Ø 7.8 mm 	DOL-2312-G07MLA3	2030685
	<ul style="list-style-type: none"> • Connection type head A: Female connector, M23, 12-pin, straight • Connection type head B: Flying leads • Signal type: Incremental • Cable: 10 m, 11-wire, PUR • Description: Incremental, shielded, Head A: female connector, M23, 12-pin, straight Head B: cable Cable: incremental, PUR, shielded, 4 x 2 x 0.25 mm² + 2 x 0.5 mm² + 1 x 0.14 mm², Ø 7.8 mm 	DOL-2312-G10MLA3	2030688
	<ul style="list-style-type: none"> • Connection type head A: Female connector, M23, 12-pin, straight • Connection type head B: Flying leads • Signal type: Incremental • Cable: 15 m, 11-wire, PUR • Description: Incremental, shielded, Head A: female connector, M23, 12-pin, straight Head B: cable Cable: incremental, PUR, shielded, 4 x 2 x 0.25 mm² + 2 x 0.5 mm² + 1 x 0.14 mm², Ø 7.8 mm 	DOL-2312-G15MLA3	2030692
	<ul style="list-style-type: none"> • Connection type head A: Female connector, M23, 12-pin, straight • Connection type head B: Flying leads • Signal type: Incremental • Cable: 20 m, 11-wire, PUR • Description: Incremental, shielded, Head A: female connector, M23, 12-pin, straight Head B: cable Cable: incremental, PUR, shielded, 4 x 2 x 0.25 mm² + 2 x 0.5 mm² + 1 x 0.14 mm², Ø 7.8 mm 	DOL-2312-G20MLA3	2030695
	<ul style="list-style-type: none"> • Connection type head A: Female connector, M23, 12-pin, straight • Connection type head B: Flying leads • Signal type: Incremental • Cable: 25 m, 11-wire, PUR • Description: Incremental, shielded, Head A: female connector, M23, 12-pin, straight Head B: cable Cable: incremental, PUR, shielded, 4 x 2 x 0.25 mm² + 2 x 0.5 mm² + 1 x 0.14 mm², Ø 7.8 mm 	DOL-2312-G25MLA3	2030699
	<ul style="list-style-type: none"> • Connection type head A: Female connector, M23, 12-pin, straight • Connection type head B: Flying leads • Signal type: Incremental • Cable: 30 m, 11-wire, PUR • Description: Incremental, shielded, Head A: female connector, M23, 12-pin, straight Head B: cable Cable: incremental, PUR, shielded, 4 x 2 x 0.25 mm² + 2 x 0.5 mm² + 1 x 0.14 mm², Ø 7.8 mm 	DOL-2312-G30MLA3	2030702
	<ul style="list-style-type: none"> • Connection type head A: Female connector, M23, 12-pin, straight • Connection type head B: Flying leads • Signal type: Incremental • Cable: 1.5 m, 12-wire, PUR, halogen-free • Description: Incremental, shielded, Head A: female connector, M23, 12-pin, straight Head B: Cable Cable: incremental, suitable for drag chain, PUR, halogen-free, shielded, 4 x 2 x 0.25 mm² + 2 x 0.5 mm² + 1 x 0.14 mm², Ø 7.8 mm 	DOL-2312-G1M5MA3	2029212
	<ul style="list-style-type: none"> • Connection type head A: Female connector, M23, 12-pin, straight • Connection type head B: Flying leads • Signal type: Incremental • Cable: 3 m, 12-wire, PUR, halogen-free • Description: Incremental, shielded, Head A: female connector, M23, 12-pin, straight Head B: Cable Cable: incremental, suitable for drag chain, PUR, halogen-free, shielded, 4 x 2 x 0.25 mm² + 2 x 0.5 mm² + 1 x 0.14 mm², Ø 7.8 mm 	DOL-2312-G03MMA3	2029213

	Brief description	Type	Part no.
	<ul style="list-style-type: none"> • Connection type head A: Female connector, M23, 12-pin, straight • Connection type head B: Flying leads • Signal type: Incremental • Cable: 5 m, 12-wire, PUR, halogen-free • Description: Incremental, shielded, Head A: female connector, M23, 12-pin, straight Head B: Cable Cable: incremental, suitable for drag chain, PUR, halogen-free, shielded, 4 x 2 x 0.25 mm² +2 x 0.5 mm² +1 x 0.14 mm², Ø 7.8 mm 	DOL-2312-G05MMA3	2029214
	<ul style="list-style-type: none"> • Connection type head A: Female connector, M23, 12-pin, straight • Connection type head B: Flying leads • Signal type: Incremental • Cable: 10 m, 12-wire, PUR, halogen-free • Description: Incremental, shielded, Head A: female connector, M23, 12-pin, straight Head B: Cable Cable: incremental, suitable for drag chain, PUR, halogen-free, shielded, 4 x 2 x 0.25 mm² +2 x 0.5 mm² +1 x 0.14 mm², Ø 7.8 mm 	DOL-2312-G10MMA3	2029215
	<ul style="list-style-type: none"> • Connection type head A: Female connector, M23, 12-pin, straight • Connection type head B: Flying leads • Signal type: Incremental • Cable: 20 m, 12-wire, PUR, halogen-free • Description: Incremental, shielded, Head A: Female connector, M23, 12-pin, straight Head B: Cable Cable: Incremental, suitable for drag chain, PUR, halogen-free, shielded, 4 x 2 x 0.25 mm² +2 x 0.5 mm² +1 x 0.14 mm², Ø 7.8 mm 	DOL-2312-G20MMA3	2029216
	<ul style="list-style-type: none"> • Connection type head A: Female connector, M23, 12-pin, straight • Connection type head B: Flying leads • Signal type: Incremental • Cable: 30 m, 12-wire, PUR, halogen-free • Description: Incremental, shielded, Head A: female connector, M23, 12-pin, straight Head B: Cable Cable: incremental, suitable for drag chain, PUR, halogen-free, shielded, 4 x 2 x 0.25 mm² +2 x 0.5 mm² +1 x 0.14 mm², Ø 7.8 mm 	DOL-2312-G30MMA3	2029217
	<ul style="list-style-type: none"> • Connection type head A: Female connector, M23, 12-pin, straight, A-coded • Signal type: HIPERFACE[®], SSI, Incremental • Description: HIPERFACE[®], SSI, Incremental, shielded, Head A: female connector, M23, 12-pin, straight, shielded, for cable diameter 5.5 mm ... 10.5 mm Head B: - Operating temperature: -40 °C ... +125 °C • Connection systems: Solder connection 	DOS-2312-G02	2077057
	<ul style="list-style-type: none"> • Connection type head A: Female connector, M23, 12-pin, angled, A-coded • Signal type: HIPERFACE[®], SSI, Incremental • Description: HIPERFACE[®], SSI, Incremental, shielded, Head A: female connector, M23, 12-pin, angled, shielded, for cable diameter 4.2 mm ... 6.6 mm Head B: - Operating temperature: -20 °C ... +130 °C • Connection systems: Solder connection 	DOS-2312-W01	2072580

SICK AT A GLANCE

SICK is one of the leading manufacturers of intelligent sensors and sensor solutions for industrial applications. A unique range of products and services creates the perfect basis for controlling processes securely and efficiently, protecting individuals from accidents and preventing damage to the environment.

We have extensive experience in a wide range of industries and understand their processes and requirements. With intelligent sensors, we can deliver exactly what our customers need. In application centers in Europe, Asia and North America, system solutions are tested and optimized in accordance with customer specifications. All this makes us a reliable supplier and development partner.

Comprehensive services complete our offering: SICK LifeTime Services provide support throughout the machine life cycle and ensure safety and productivity.

For us, that is “Sensor Intelligence.”

WORLDWIDE PRESENCE:

Contacts and other locations –www.sick.com