



DFS60I-BJWC01000

DFS60

INCREMENTAL ENCODERS

SICK
Sensor Intelligence.



Illustration may differ



Ordering information

Type	Part no.
DFS60I-BJWC01000	1104089

Other models and accessories → www.sick.com/DFS60

Detailed technical data

Safety-related parameters

MTTF_D (mean time to dangerous failure)	300 years (EN ISO 13849-1) ¹⁾
--	--

¹⁾ This product is a standard product and does not constitute a safety component as defined in the Machinery Directive. Calculation based on nominal load of components, average ambient temperature 40 °C, frequency of use 8760 h/a. All electronic failures are considered hazardous. For more information, see document no. 8015532.

Performance

Pulses per revolution	1,000 ¹⁾
Measuring step	90°, electric/pulses per revolution
Measuring step deviation at non binary number of lines	± 0.008°
Error limits	± 0.03°

¹⁾ See maximum revolution range.

Interfaces

Communication interface	Incremental
Communication Interface detail	HTL / Push pull
Number of signal channels	6-channel
0-set function via hardware pin	✓
0-SET function	H-active, L ≙ 0 - 3 V, H ≙ 4.0 - U _S V ¹⁾
Initialization time	30 ms
Output frequency	≤ 820 kHz
Load current	≤ 30 mA
Operating current	40 mA (without load)
Power consumption	≤ 0.7 W (without load)
Load resistance	≥ 120 Ω

¹⁾ Only with devices with M12 connector in connection with electrical interfaces M, V and W.

Electronics

Connection type	Male connector, M12, 12-pin, radial
Supply voltage	4.5 ... 32 V
Reference signal, number	1
Reference signal, position	90°, electric, logically gated with A and B
Reverse polarity protection	✓
Short-circuit protection of the outputs	✓ ¹⁾

¹⁾ Short-circuit opposite to another channel, US or GND permissible for maximum 30 s.

Mechanics

Mechanical design	Blind hollow shaft
Shaft diameter	5/8"
Weight	+ 0.5 kg
Shaft material	Stainless steel V2A
Flange material	Stainless steel V2A
Housing material	Stainless steel V2A
Start up torque	1 Ncm (+20 °C)
Operating torque	0.5 Ncm (+20 °C)
Permissible movement static	± 0.3 mm (radial) ± 0.5 mm (axial)
Permissible movement dynamic	± 0.05 mm (radial) ± 0.01 mm (axial)
Operating speed	≤ 6,000 min ⁻¹ ¹⁾
Moment of inertia of the rotor	40 gcm ²
Bearing lifetime	3.6 x 10 ¹⁰ revolutions
Angular acceleration	≤ 500,000 rad/s ²

¹⁾ Allow for self-heating of 3.3 K per 1,000 rpm when designing the operating temperature range.

Ambient data

EMC	According to EN 61000-6-2 and EN 61000-6-3
Enclosure rating	IP67, housing side (IEC 60529) ¹⁾ IP67, shaft side (IEC 60529)
Permissible relative humidity	90 % (Condensation not permitted)
Operating temperature range	-40 °C ... +100 °C ²⁾ -30 °C ... +100 °C ³⁾
Storage temperature range	-40 °C ... +100 °C, without package
Resistance to shocks	100 g, 6 ms (EN 60068-2-27)
Resistance to vibration	10 g, 10 Hz ... 2,000 Hz (EN 60068-2-6)

¹⁾ With mating connector fitted.

²⁾ Stationary position of the cable.

³⁾ Flexible position of the cable.

Classifications

ECLASS 5.0	27270501
ECLASS 5.1.4	27270501

ECLASS 6.0	27270590
ECLASS 6.2	27270590
ECLASS 7.0	27270501
ECLASS 8.0	27270501
ECLASS 8.1	27270501
ECLASS 9.0	27270501
ECLASS 10.0	27270501
ECLASS 11.0	27270501
ECLASS 12.0	27270501
ETIM 5.0	EC001486
ETIM 6.0	EC001486
ETIM 7.0	EC001486
ETIM 8.0	EC001486
UNSPSC 16.0901	41112113

Dimensional drawing (Dimensions in mm (inch))

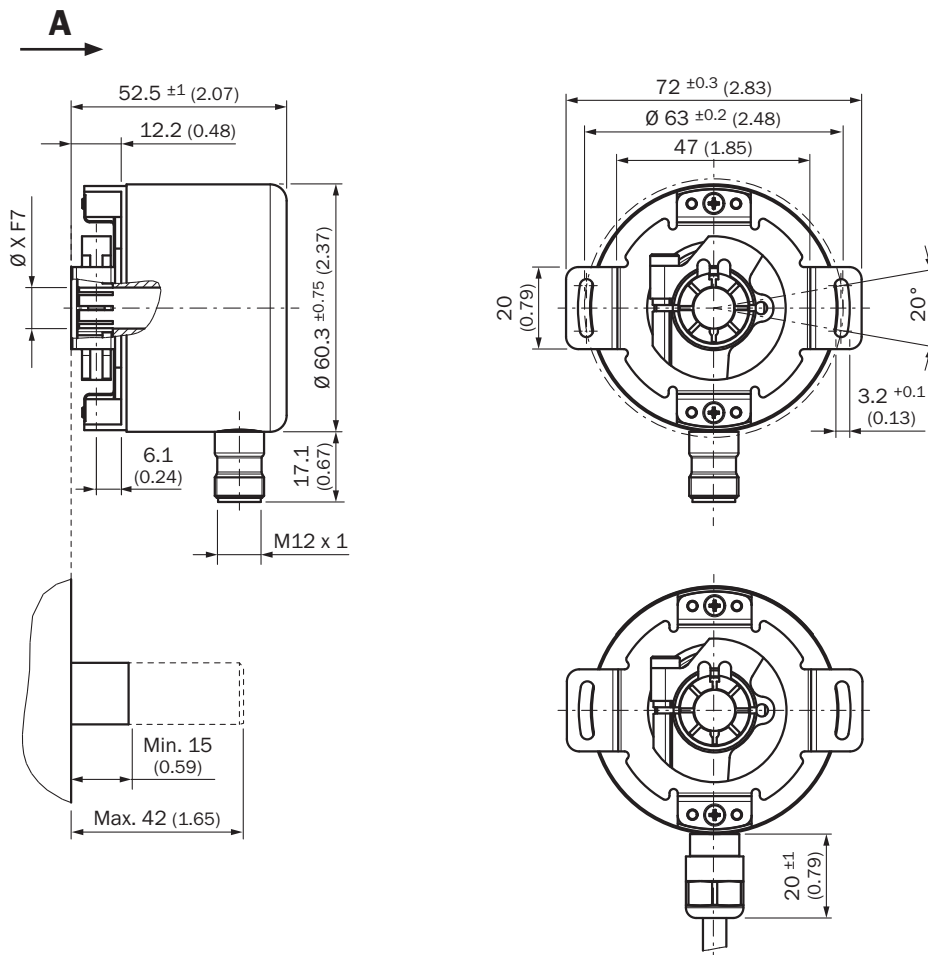

PIN assignment

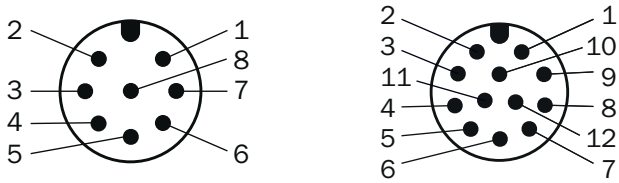

View of M12 male device connector on encoder

Male connector M12, 8-pin	Connector M12, 12-pin	Wire colors (cable connection)	TTL/HTL signal	Sin/Cos 1.0 V _{PP}	Explanation
1	7	Brown	\bar{A}	COS-	Signal wire
2	6	White	A	COS+	Signal wire
3	9	Black	\bar{B}	SIN-	Signal wire
4	8	Pink	B	SIN+	Signal wire
5	4	Yellow	\bar{Z}	\bar{Z}	Signal wire
6	11	Purple	Z	Z	Signal wire
7	12	Blue	GND	GND	Ground connection
8	5	Red	+U _S	+U _S	Supply voltage
-	2	-	N.c.	N.c.	Not assigned
-	3	-	N.c.	N.c.	Not assigned
-	1	-	N.c.	N.c.	Not assigned
-	10 ¹⁾	-	O-SET ¹⁾	N.c.	Set zero pulse ¹⁾
Screen	Screen	Screen	Screen	Screen	Screen connected to housing on encoder side. Connected to ground on control side.

Diagrams

Signal outputs

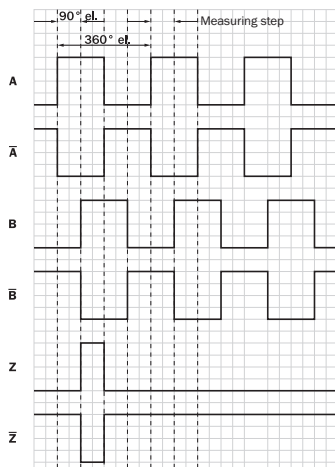

CW with view on the encoder shaft in direction "A", compare dimensional drawing.





Maximum revolution range





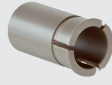

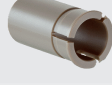
Supply voltage	Output
4,5 V ... 5,5 V	TTL
10 V ... 32 V	TTL
10 V ... 32 V	HTL

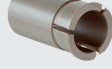
Recommended accessories

Other models and accessories → www.sick.com/DFS60

	Brief description	Type	Part no.
Flanges			
	Standard stator coupling	BEF-DS00XFX	2056812
Shaft adaptation			
	Collet plastic (PEEK) insulated for hollow shaft, shaft diameter 6 mm, outer diameter 5/8" (15.875 mm), plastic, PEEK	SPZ-58Z-006-P	2076228
	Collet metal for hollow shaft, shaft diameter 8 mm, outer diameter 5/8" (15.875 mm), metal	SPZ-58Z-008-M	2076219
	Collet plastic (PEEK) insulated for hollow shaft, shaft diameter 8 mm, outer diameter 5/8" (15.875 mm), plastic, PEEK	SPZ-58Z-008-P	2076229
	Collet metal for hollow shaft, shaft diameter 10 mm, outer diameter 5/8" (15.875 mm), metal	SPZ-58Z-010-M	2076220
	Collet plastic (PEEK) insulated for hollow shaft, shaft diameter 10 mm, outer diameter 5/8" (15.875 mm), plastic, PEEK	SPZ-58Z-010-P	2076230

	Brief description	Type	Part no.
	Collet metal for hollow shaft, shaft diameter 11 mm, outer diameter 5/8" (15.875 mm), metal	SPZ-58Z-011-M	2094671
	Collet metal for hollow shaft, shaft diameter 12 mm, outer diameter 5/8" (15.875 mm), metal	SPZ-58Z-012-M	2076221
	Collet plastic (PEEK) insulated for hollow shaft, shaft diameter 12 mm, outer diameter 5/8" (15.875 mm), plastic, PEEK	SPZ-58Z-012-P	2076231
	Collet metal for hollow shaft, shaft diameter 14 mm, outer diameter 5/8" (15.875 mm), metal	SPZ-58Z-014-M	2076222
	Collet plastic (PEEK) insulated for hollow shaft, shaft diameter 14 mm, outer diameter 5/8" (15.875 mm), plastic, PEEK	SPZ-58Z-014-P	2076232
	Collet metal for hollow shaft, shaft diameter 15 mm, outer diameter 5/8" (15.875 mm), metal	SPZ-58Z-015-M	2076223
	Collet plastic (PEEK) insulated for hollow shaft, shaft diameter 15 mm, outer diameter 5/8" (15.875 mm), plastic, PEEK	SPZ-58Z-015-P	2076233
	Collet metal for hollow shaft, shaft diameter 1/2" (12.7 mm), outer diameter 5/8" (15.875 mm), metal	SPZ-58Z-12Z-M	2076225
	Collet plastic (PEEK) insulated for hollow shaft, shaft diameter 1/2" (12.7 mm), outer diameter 5/8" (15.875 mm), plastic, PEEK	SPZ-58Z-12Z-P	2076227
	Collet metal for hollow shaft, shaft diameter 3/8" (9.525 mm), outer diameter 5/8" (15.875 mm), metal	SPZ-58Z-38Z-M	2076224
	Collet plastic (PEEK) insulated for hollow shaft, shaft diameter 3/8" (9.525 mm), outer diameter 5/8" (15.875 mm), plastic, PEEK	SPZ-58Z-38Z-P	2076226
Others			
	<ul style="list-style-type: none"> • Connection type head A: Male connector, M12, 8-pin, straight, A-coded • Description: Shielded • Connection systems: Screw-type terminals • Permitted cross-section: ≤ 0.5 mm² • Application: Hygienic and washdown zones 	YM12ES8-0050S5586A	2097337
	<ul style="list-style-type: none"> • Connection type head A: Female connector, M12, 8-pin, straight, A-coded • Description: Shielded • Connection systems: Screw-type terminals • Permitted cross-section: 0.25 mm² ... 0.5 mm² • Application: Hygienic and washdown zones 	YF12ES8-0050S5586A	2097334
	<ul style="list-style-type: none"> • Connection type head A: Female connector, M12, 12-pin, straight, A-coded • Connection type head B: Flying leads • Signal type: SSI • Cable: 2 m, 12-wire, PUR, halogen-free • Description: SSI, shielded, Female connector, M12, 12-pin • Note: Drag chain use 	DOL-1212-G02MAC1	6053273
	<ul style="list-style-type: none"> • Connection type head A: Female connector, M12, 12-pin, straight, A-coded • Connection type head B: Flying leads • Signal type: SSI • Cable: 5 m, 12-wire, PUR, halogen-free • Description: SSI, shielded, Female connector, M12, 12-pin, angled, 5 m, PVC, shielded, drilled and twisted pair • Note: Drag chain use 	DOL-1212-G05MAC1	6053274

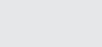
	Brief description	Type	Part no.
	<ul style="list-style-type: none"> • Connection type head A: Female connector, M12, 12-pin, straight, A-coded • Connection type head B: Flying leads • Signal type: SSI • Cable: 10 m, 12-wire, PUR, halogen-free • Description: SSI, shielded, Female cable connector, M12, 12-pin • Note: Drag chain use 	DOL-1212-G10MAC1	6053275
	<ul style="list-style-type: none"> • Connection type head A: Female connector, M12, 12-pin, straight, A-coded • Connection type head B: Flying leads • Signal type: SSI • Cable: 20 m, 12-wire, PUR, halogen-free • Description: SSI, shielded, Female connector, M12, 12-pin, angled, 5 m, PVC, shielded, drilled and twisted pair • Note: Drag chain use 	DOL-1212-G20MAC1	6053276
	<ul style="list-style-type: none"> • Connection type head A: Female connector, M12, 12-pin, angled, A-coded • Connection type head B: Flying leads • Signal type: SSI • Cable: 2 m, 12-wire, PUR, halogen-free • Description: SSI, shielded, Head A: female connector, M12, 12-pin, angled Head B: cable Cable: SSI, PUR, halogen-free, shielded, 12 x 0.14 mm², Ø 8.5 mm, suitable for drag chain 	DOL-1212-W02MAC1	6039824
	<ul style="list-style-type: none"> • Connection type head A: Female connector, M12, 12-pin, angled, A-coded • Connection type head B: Flying leads • Signal type: SSI • Cable: 5 m, 12-wire, PUR, halogen-free • Description: SSI, shielded, Head A: female connector, M12, 12-pin, angled Head B: cable Cable: SSI, PUR, halogen-free, shielded, 12 x 0.14 mm², Ø 8.5 mm, suitable for drag chain • Note: Drag chain use 	DOL-1212-W05MAC1	6039825
	<ul style="list-style-type: none"> • Connection type head A: Female connector, M12, 12-pin, angled, A-coded • Connection type head B: Flying leads • Signal type: SSI • Cable: 10 m, 12-wire, PUR, halogen-free • Description: SSI, shielded, Head A: female connector, M12, 12-pin, angled Head B: cable Cable: SSI, PUR, halogen-free, shielded, 12 x 0.14 mm², Ø 8.5 mm, suitable for drag chain • Note: Drag chain use 	DOL-1212-W10MAC1	6039826
	<ul style="list-style-type: none"> • Connection type head A: Female connector, M12, 12-pin, angled, A-coded • Connection type head B: Flying leads • Signal type: SSI • Cable: 20 m, 12-wire, PUR, halogen-free • Description: SSI, shielded, Head A: female connector, M12, 12-pin, angled Head B: cable Cable: SSI, PUR, halogen-free, shielded, 12 x 0.14 mm², Ø 8.5 mm, suitable for drag chain • Note: Drag chain use 	DOL-1212-W20MAC1	6039827

SICK AT A GLANCE

SICK is one of the leading manufacturers of intelligent sensors and sensor solutions for industrial applications. A unique range of products and services creates the perfect basis for controlling processes securely and efficiently, protecting individuals from accidents and preventing damage to the environment.

We have extensive experience in a wide range of industries and understand their processes and requirements. With intelligent sensors, we can deliver exactly what our customers need. In application centers in Europe, Asia and North America, system solutions are tested and optimized in accordance with customer specifications. All this makes us a reliable supplier and development partner.

Comprehensive services complete our offering: SICK LifeTime Services provide support throughout the machine life cycle and ensure safety and productivity.

For us, that is “Sensor Intelligence.”

WORLDWIDE PRESENCE:

Contacts and other locations –www.sick.com