

DGS80B-TSH402048

DGS80

INCREMENTAL ENCODERS

SICK
Sensor Intelligence.



Illustration may differ



Ordering information

Type	Part no.
DGS80B-TSH402048	1118667

Other models and accessories → www.sick.com/DGS80

Detailed technical data

Safety-related parameters

MTTF_D (mean time to dangerous failure)	518 years (EN ISO 13849-1) ¹⁾
--	--

¹⁾ This product is a standard product and does not constitute a safety component as defined in the Machinery Directive. Calculation based on nominal load of components, average ambient temperature 40°C, frequency of use 8760 h/a. All electronic failures are considered hazardous. For more information, see document no. 8015532.

Performance

Pulses per revolution	2,048
Measuring step	90°, electric/pulses per revolution
Measuring step deviation	± 15° electrical
Duty cycle	≤ 0.5 ± 15 %

Interfaces

Communication interface	Incremental
Communication Interface detail	TTL / RS-422
Number of signal channels	6-channel
Initialization time	< 50 ms
Output frequency	≤ 300 kHz
Load current	≤ 40 mA, per channel
Operating current	≤ 50 mA (without load)
Power consumption	≤ 0.85 W

Electrical data

Connection type	Male connector, MS, 10-pin, radial
Supply voltage	5 ... 30 V
Reference signal, position	90°, electric, logically gated with A and B
Reverse polarity protection	✓
Short-circuit protection of the outputs	✓

Mechanical data

Mechanical design	Through hollow shaft
Shaft diameter	30 mm ¹⁾
Flange type / stator coupling	1-sided stator coupling with slot available for order as accessory
Weight	650 g
Shaft material	Aluminum
Flange material	ZAMAC die cast
Housing material	ZAMAC die cast
Shaft sealing ring material	FKM70
Start up torque	6 Ncm (+20 °C)
Operating torque	5 Ncm (+20 °C)
Permissible shaft loading	100 N (radial) 100 N (axial)
Operating speed	≤ 3,600 min ⁻¹
Moment of inertia of the rotor	408 gcm ²
Bearing lifetime	10 ⁹ revolutions

¹⁾ Collets (shaft reducer) available as accessories to reduce shaft sizes under 30 mm / 42 mm.

Ambient data

EMC	According to EN 61000-6-2 and EN 61000-6-3
Enclosure rating	IP65 (IEC 60529)
Permissible relative humidity	98 % (Condensation not permitted)
Operating temperature range	-25 °C ... +85 °C
Storage temperature range	-25 °C ... +85 °C, without package
Resistance to shocks	250 g, 6 ms (EN 60068-2-27)
Resistance to vibration	10 g, 5 Hz ... 2,000 Hz (EN 60068-2-6)

Classifications

ECLASS 5.0	27270501
ECLASS 5.1.4	27270501
ECLASS 6.0	27270590
ECLASS 6.2	27270590
ECLASS 7.0	27270501
ECLASS 8.0	27270501
ECLASS 8.1	27270501
ECLASS 9.0	27270501
ECLASS 10.0	27270501
ECLASS 11.0	27270501
ECLASS 12.0	27270501
ETIM 5.0	EC001486
ETIM 6.0	EC001486
ETIM 7.0	EC001486
ETIM 8.0	EC001486

UNSPSC 16.0901

41112113

Dimensional drawing (Dimensions in mm (inch))

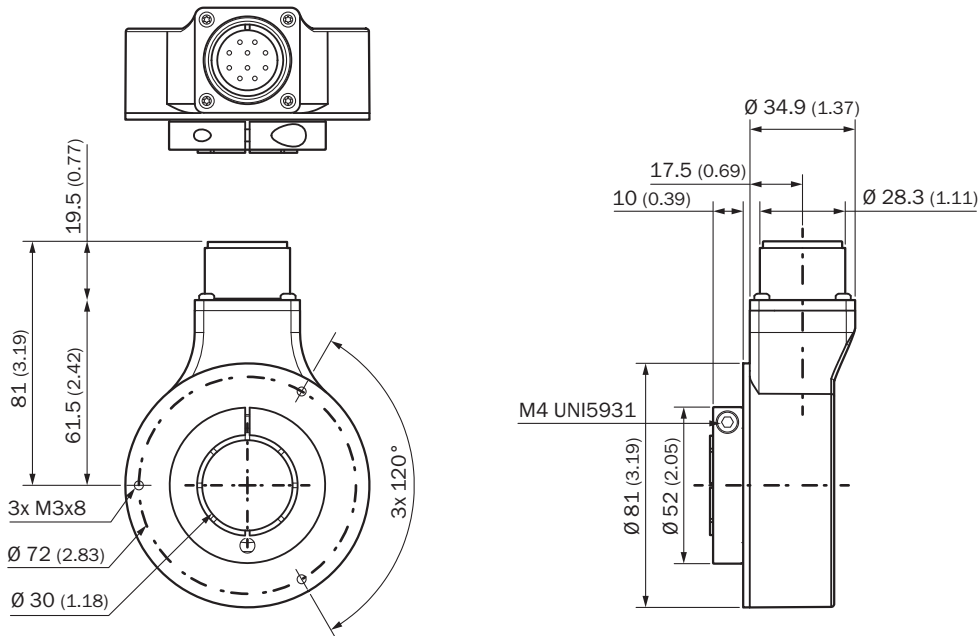

PIN assignment

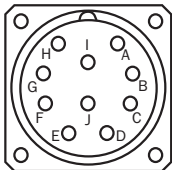











Wire colors (cable connection)	PIN Male connector M12, 8-pin	PIN Male connector M23, 12-pin	PIN MS male connector, 10-pin	Signal	Explanation
Brown	1	6	H	A-	Signal cable
White	2	5	A	A	Signal cable
Black	3	1	I	B-	Signal cable
Pink	4	8	B	B	Signal cable
Yellow	5	4	J	Z-	Signal cable
Purple	6	3	C	Z	Signal cable
Blue	7	10	F	GND	Ground connection
Red	8	12	D	+U _S	Supply voltage
-	-	2	E	N.c.	Not connected
-	-	7	-	N.c.	Not connected
-	-	-	G	Housing	Housing
-	-	9	-	N.c.	Not connected

Wire colors (cable connection)	PIN Male connector M12, 8-pin	PIN Male connector M23, 12-pin	PIN MS male connector, 10-pin	Signal	Explanation
-	-	11	-	N.c.	Not connected
Screen				Screen	Screen connected to housing on encoder side

Recommended accessories

Other models and accessories → www.sick.com/DGS80

	Brief description	Type	Part no.
Flanges			
	1-sided stator coupling, slot, 115 mm, stainless steel 1.4301 (AISI 304), 1 x stator coupling, 3 x M3 screws, 1 x insulating washer for stator coupling	DGS80-TETHER-A	2122697
	1-sided stator coupling, slot, 84 mm, stainless steel 1.4301 (AISI 304), 1 x stator coupling, 3 x M3 screws, 1 x insulating washer for stator coupling	DGS80-TETHER-B	2122698
	1-sided stator coupling, slot, 67 mm, stainless steel 1.4301 (AISI 304), 1 x stator coupling, 3 x M3 screws	DGS80-TETHER-C	2135677
Shaft adaptation			
	Collet for through hollow shaft, shaft diameter 1/2", external diameter 30 mm	SPZ-030-012Z-M	2142263
	Collet for through hollow shaft, shaft diameter 16 mm, external diameter 30 mm	SPZ-030-016-M	2123016
	Collet for through hollow shaft, shaft diameter 18 mm, external diameter 30 mm	SPZ-030-018-M	2123017
	Collet for through hollow shaft, shaft diameter 1", external diameter 30 mm	SPZ-030-01Z-M	2123015
	Collet for through hollow shaft, shaft diameter 20 mm, external diameter 30 mm	SPZ-030-020-M	2123018
	Collet for through hollow shaft, shaft diameter 24 mm, external diameter 30 mm	SPZ-030-024-M	2123019
	Collet for through hollow shaft, shaft diameter 25 mm, external diameter 30 mm	SPZ-030-025-M	2123020
	Collet for through hollow shaft, shaft diameter 28 mm, external diameter 30 mm	SPZ-030-028-M	2123021
	Collet for through hollow shaft, shaft diameter 3/4", external diameter 30 mm	SPZ-030-034Z-M	2123014
Collet for through hollow shaft, shaft diameter 5/8", external diameter 30 mm	SPZ-030-058Z-M	2123013	
Others			
	<ul style="list-style-type: none"> Connection type head A: Female connector, MS/10, 10-pin, straight, A-coded Description: Unshielded 	DOS-MS10-G	7102129
	<ul style="list-style-type: none"> Connection type head A: Female connector, MS/10, 10-pin, straight Connection type head B: Flying leads Cable: 3 m, 11-wire Description: Shielded 	DOL-MS10-G03MMA2	7102131
	<ul style="list-style-type: none"> Connection type head A: Female connector, MS/10, 10-pin, straight Connection type head B: Flying leads Cable: 5 m, 11-wire Description: Shielded 	DOL-MS10-G05MMA2	7102132

	Brief description	Type	Part no.
	<ul style="list-style-type: none"> Connection type head A: Female connector, MS/10, 10-pin, straight Connection type head B: Flying leads Cable: 1.5 m, 11-wire Description: Shielded 	DOL-MS10-G1M5MA2	7102130
	<ul style="list-style-type: none"> Connection type head A: Female connector, MS/10, 10-pin, straight Connection type head B: Flying leads Cable: 10 m, 11-wire Description: Shielded 	DOL-MS10-G10MMA2	7102133
	<ul style="list-style-type: none"> Connection type head A: Female connector, MS/10, 10-pin, straight Connection type head B: Flying leads Cable: 20 m, 11-wire Description: Shielded 	DOL-MS10-G20MMA2	7102134
	<ul style="list-style-type: none"> Connection type head A: Female connector, MS/10, 10-pin, straight Connection type head B: Flying leads Cable: 30 m, 11-wire Description: Shielded 	DOL-MS10-G30MMA2	7102135

SICK AT A GLANCE

SICK is one of the leading manufacturers of intelligent sensors and sensor solutions for industrial applications. A unique range of products and services creates the perfect basis for controlling processes securely and efficiently, protecting individuals from accidents and preventing damage to the environment.

We have extensive experience in a wide range of industries and understand their processes and requirements. With intelligent sensors, we can deliver exactly what our customers need. In application centers in Europe, Asia and North America, system solutions are tested and optimized in accordance with customer specifications. All this makes us a reliable supplier and development partner.

Comprehensive services complete our offering: SICK LifeTime Services provide support throughout the machine life cycle and ensure safety and productivity.

For us, that is “Sensor Intelligence.”

WORLDWIDE PRESENCE:

Contacts and other locations –www.sick.com