

DGS80B-TYHA02048

DGS80

INCREMENTAL ENCODERS

SICK
Sensor Intelligence.

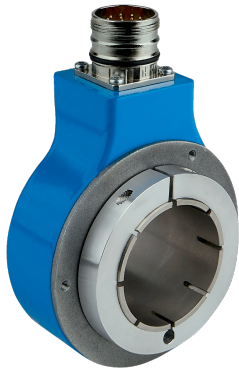

Illustration may differ



Ordering information

| Type | Part no. |
|------------------|----------|
| DGS80B-TYHA02048 | 1118721 |

Other models and accessories → www.sick.com/DGS80

Detailed technical data

Safety-related parameters

| | |
|--|--|
| MTTF_D (mean time to dangerous failure) | 518 years (EN ISO 13849-1) ¹⁾ |
|--|--|

¹⁾ This product is a standard product and does not constitute a safety component as defined in the Machinery Directive. Calculation based on nominal load of components, average ambient temperature 40°C, frequency of use 8760 h/a. All electronic failures are considered hazardous. For more information, see document no. 8015532.

Performance

| | |
|---------------------------------|-------------------------------------|
| Pulses per revolution | 2,048 |
| Measuring step | 90°, electric/pulses per revolution |
| Measuring step deviation | ± 15° electrical |
| Duty cycle | ≤ 0.5 ± 15 % |

Interfaces

| | |
|---------------------------------------|------------------------|
| Communication interface | Incremental |
| Communication Interface detail | TTL / RS-422 |
| Number of signal channels | 6-channel |
| Initialization time | < 50 ms |
| Output frequency | ≤ 300 kHz |
| Load current | ≤ 40 mA, per channel |
| Operating current | ≤ 50 mA (without load) |
| Power consumption | ≤ 0.85 W |

Electrical data

| | |
|--|---|
| Connection type | Male connector, M23, 12-pin, radial |
| Supply voltage | 5 ... 30 V |
| Reference signal, position | 90°, electric, logically gated with A and B |
| Reverse polarity protection | ✓ |
| Short-circuit protection of the outputs | ✓ |

Mechanical data

| | |
|---------------------------------------|--|
| Mechanical design | Through hollow shaft |
| Shaft diameter | 42 mm ¹⁾ |
| Flange type / stator coupling | 1-sided stator coupling with slot available for order as accessory |
| Weight | 650 g |
| Shaft material | Aluminum |
| Flange material | ZAMAC die cast |
| Housing material | ZAMAC die cast |
| Shaft sealing ring material | FKM70 |
| Start up torque | 6 Ncm (+20 °C) |
| Operating torque | 5 Ncm (+20 °C) |
| Permissible shaft loading | 160 N (radial) 100 N (axial) |
| Operating speed | ≤ 3,600 min ⁻¹ |
| Moment of inertia of the rotor | 877 gcm ² |
| Bearing lifetime | 10 ⁹ revolutions |

¹⁾ Collets (shaft reducer) available as accessories to reduce shaft sizes under 30 mm / 42 mm.

Ambient data

| | |
|--------------------------------------|--|
| EMC | According to EN 61000-6-2 and EN 61000-6-3 |
| Enclosure rating | IP65 (IEC 60529) |
| Permissible relative humidity | 98 % (Condensation not permitted) |
| Operating temperature range | -25 °C ... +85 °C |
| Storage temperature range | -25 °C ... +85 °C, without package |
| Resistance to shocks | 250 g, 6 ms (EN 60068-2-27) |
| Resistance to vibration | 10 g, 5 Hz ... 2,000 Hz (EN 60068-2-6) |

Classifications

| | |
|---------------------|----------|
| ECLASS 5.0 | 27270501 |
| ECLASS 5.1.4 | 27270501 |
| ECLASS 6.0 | 27270590 |
| ECLASS 6.2 | 27270590 |
| ECLASS 7.0 | 27270501 |
| ECLASS 8.0 | 27270501 |
| ECLASS 8.1 | 27270501 |
| ECLASS 9.0 | 27270501 |
| ECLASS 10.0 | 27270501 |
| ECLASS 11.0 | 27270501 |
| ECLASS 12.0 | 27270501 |
| ETIM 5.0 | EC001486 |
| ETIM 6.0 | EC001486 |
| ETIM 7.0 | EC001486 |
| ETIM 8.0 | EC001486 |

UNSPSC 16.0901

41112113

Dimensional drawing (Dimensions in mm (inch))

Bore hole size 42 mm, M23 male connector

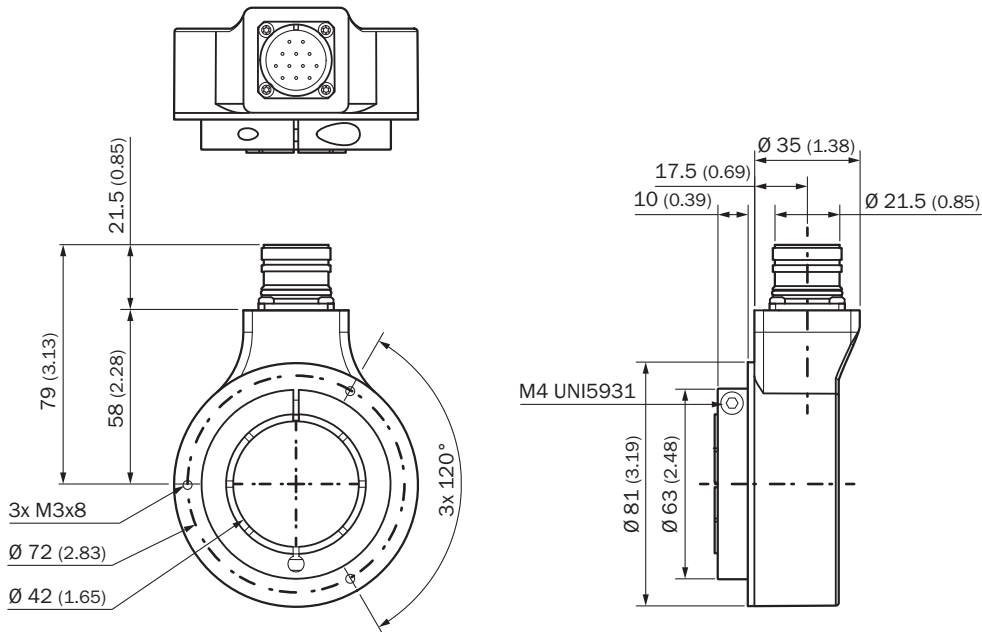

PIN assignment

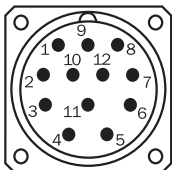





| Wire colors (cable connection) | PIN Male connector M12, 8-pin | PIN Male connector M23, 12-pin | PIN MS male connector, 10-pin | Signal | Explanation |
|--------------------------------|-------------------------------|--------------------------------|-------------------------------|-----------------|-------------------|
| Brown | 1 | 6 | H | A- | Signal cable |
| White | 2 | 5 | A | A | Signal cable |
| Black | 3 | 1 | I | B- | Signal cable |
| Pink | 4 | 8 | B | B | Signal cable |
| Yellow | 5 | 4 | J | Z- | Signal cable |
| Purple | 6 | 3 | C | Z | Signal cable |
| Blue | 7 | 10 | F | GND | Ground connection |
| Red | 8 | 12 | D | +U _S | Supply voltage |
| - | - | 2 | E | N.c. | Not connected |
| - | - | 7 | - | N.c. | Not connected |
| - | - | - | G | Housing | Housing |

| Wire colors (cable connection) | PIN Male connector M12, 8-pin | PIN Male connector M23, 12-pin | PIN MS male connector, 10-pin | Signal | Explanation |
|--------------------------------|-------------------------------|--------------------------------|-------------------------------|--------|---|
| - | - | 9 | - | N.c. | Not connected |
| - | - | 11 | - | N.c. | Not connected |
| Screen | | | | Screen | Screen connected to housing on encoder side |

Recommended accessories

Other models and accessories → www.sick.com/DGS80

| | Brief description | Type | Part no. |
|---|---|----------------|----------|
| Flanges | | | |
|  | 1-sided stator coupling, slot, 115 mm, stainless steel 1.4301 (AISI 304), 1 x stator coupling, 3 x M3 screws, 1 x insulating washer for stator coupling | DGS80-TETHER-A | 2122697 |
|  | 1-sided stator coupling, slot, 84 mm, stainless steel 1.4301 (AISI 304), 1 x stator coupling, 3 x M3 screws, 1 x insulating washer for stator coupling | DGS80-TETHER-B | 2122698 |
|  | 1-sided stator coupling, slot, 67 mm, stainless steel 1.4301 (AISI 304), 1 x stator coupling, 3 x M3 screws | DGS80-TETHER-C | 2135677 |
| Shaft adaptation | | | |
|  | Collet for through hollow shaft, shaft diameter 30 mm, external diameter 42 mm | SPZ-042-030-M | 2123008 |
| | Collet for through hollow shaft, shaft diameter 32 mm, external diameter 42 mm | SPZ-042-032-M | 2123009 |
| | Collet for through hollow shaft, shaft diameter 35 mm, external diameter 42 mm | SPZ-042-035-M | 2123010 |
| | Collet for through hollow shaft, shaft diameter 38 mm, external diameter 42 mm | SPZ-042-038-M | 2123011 |
| | Collet for through hollow shaft, shaft diameter 40 mm, external diameter 42 mm | SPZ-042-040-M | 2123012 |
| | Collet for through hollow shaft, shaft diameter 1 1/8", external diameter 42 mm | SPZ-042-118Z-M | 2143603 |

SICK AT A GLANCE

SICK is one of the leading manufacturers of intelligent sensors and sensor solutions for industrial applications. A unique range of products and services creates the perfect basis for controlling processes securely and efficiently, protecting individuals from accidents and preventing damage to the environment.

We have extensive experience in a wide range of industries and understand their processes and requirements. With intelligent sensors, we can deliver exactly what our customers need. In application centers in Europe, Asia and North America, system solutions are tested and optimized in accordance with customer specifications. All this makes us a reliable supplier and development partner.

Comprehensive services complete our offering: SICK LifeTime Services provide support throughout the machine life cycle and ensure safety and productivity.

For us, that is “Sensor Intelligence.”

WORLDWIDE PRESENCE:

Contacts and other locations –www.sick.com