



DL1000-S11101

Dx1000

LONG RANGE DISTANCE SENSORS

SICK
Sensor Intelligence.



Ordering information

Type	Part no.
DL1000-S11101	1075438

Other models and accessories → www.sick.com/Dx1000



Detailed technical data

Features

Measurement principle	HDDM ⁺
Measuring range	0.2 m ... 1,500 m, on “diamond grade” reflective tape ^{1) 2) 3)}
Target	Reflector
Resolution	0.001 mm ... 100 mm, adjustable ⁴⁾
Repeatability	≥ 1 mm, See repeatability characteristic lines ^{1) 5) 6) 7)}
Measurement accuracy	Typ. ± 15 mm, See measurement accuracy diagram ⁸⁾
Response time	3 ms ... 384 ms ⁷⁾
Measurement cycle time	1 ms 4 ms 16 ms
Output time	≥ 1 ms ⁹⁾
Light source	Infrared light (905 nm, measuring laser) Visible red light (650 nm, Adjustment aid)
Laser class	1, even with simultaneous operation of measurement and alignment laser (IEC 60825-1:2014, EN 60825-1:2014)
Typ. light spot size (distance)	5 mm x 20 mm (at 1 m) ¹⁰⁾ 20 mm x 20 mm (at 5 m) ¹⁰⁾ 35 mm x 25 mm (at 10 m) ¹⁰⁾ 150 mm x 50 mm (at 50 m) ¹⁰⁾

- 1) With max. ambient light 100 kLux sunlight.
- 2) See measuring range diagram.
- 3) Dependent on reflector size and measuring cycle time.
- 4) Data interface resolution.
- 5) Statistical error 1 σ, environmental conditions constant, min. warm-up time > about 15 min.
- 6) On “diamond grade” reflective tape.
- 7) Dependent on selected filter settings and measuring cycle time.
- 8) At T = +23 °C and after warm-up time > about 15 min.
- 9) Depending on interface used.
- 10) See light spot size diagram.
- 11) Measuring laser.

	290 mm x 80 mm (at 100 m) ¹⁰⁾ 4,200 mm x 920 mm (≥ 1,500 mm) ¹⁰⁾
Filter	Rain and snow filter Fog filter Moving average distance value Kalman filter Moving average speed value
Additional function	Selection of relevant distance and signal level range Selection of first or last echo in selected distance and signal level range
Average laser service life (at 25 °C)	100,000 h ¹¹⁾
Max. movement speed	128 m/s
Safety-related parameters	
	MTTF _D 101 years
	DC _{avg} 0%

- 1) With max. ambient light 100 kLux sunlight.
 2) See measuring range diagram.
 3) Dependent on reflector size and measuring cycle time.
 4) Data interface resolution.
 5) Statistical error 1 σ, environmental conditions constant, min. warm-up time > about 15 min.
 6) On “diamond grade” reflective tape.
 7) Dependent on selected filter settings and measuring cycle time.
 8) At T = +23 °C and after warm-up time > about 15 min.
 9) Depending on interface used.
 10) See light spot size diagram.
 11) Measuring laser.

Interfaces

Ethernet	✓, TCP/IP
	Function Parameterization, output of measurement data
	Data transmission rate 10/100 MBit/s
Serial	✓, RS-422
	Remark Switchable to SSI
	Function Parameterization, output of measurement data
SSI	✓
	Remark Switchable to RS-422
	Function Output of measurement data
Inputs/outputs	
	In1/Q1 Digital input, digital output (Switchable)
	QA/Q2 Analog output, digital output (Switchable)
	Q ₃ Digital output
	Q ₄ Digital output
	In ₂ Digital input
Digital input	Internal pull-down circuit HIGH switching voltage: min. 13 V ... max. supply voltage LOW switching voltage: max. 5 V 5 V switching functions: deactivate measuring laser, activate alignment laser, preset
Digital output	

- 1) Short-circuit protected, switching voltage U_V - 4 V.
 2) Internal pull-down switching, switching voltage HIGH: min. 13 V ... max. supply voltage, switching voltage LOW: max. 5 V.
 3) Max. load = (U_V - 7 V) / 21.5 mA.

	Number	2 ... 4 ^{1) 2)}
	Type	Push-pull: PNP/NPN
	Maximum output current I_A	≤ 100 mA
Analog output		
	Number	1
	Type	Current output
	Current	4 mA ... 20 mA ³⁾
	Resolution	16 bit

¹⁾ Short-circuit protected, switching voltage U_V - 4 V.

²⁾ Internal pull-down switching, switching voltage HIGH: min. 13 V ... max. supply voltage, switching voltage LOW: max. 5 V.

³⁾ Max. load = $(U_V - 7 \text{ V}) / 21.5 \text{ mA}$.

Electronics

Supply voltage U_B	DC 18 V ... 30 V, reverse polarity protected
Power consumption	≤ 22 W, With heating switched off ¹⁾ ≤ 35 W, With heating switched on ¹⁾
Ripple	≤ 5 V _{pp} ²⁾
Initialization time	> 15 s
Indication	Graphical, resistive touch display, status LEDs
Enclosure rating	IP65 ³⁾ IP67 ³⁾
Protection class	III (EN 61140)

¹⁾ With external load.

²⁾ May not fall short of or exceed V_S tolerances.

³⁾ When plugged in with a suitable mating connector.

Mechanics

Dimensions (W x H x D)	84 mm x 104.4 mm x 140.5 mm
Housing material	Metal (Aluminum alloy (AlSi12))
Window material	Glass
Weight	980 g
Connection type	Round connector M12 x 1

Ambient data

Ambient temperature, operation	-40 °C ... +55 °C ¹⁾ -40 °C ... +95 °C, operation with cooling case
Ambient temperature, storage	-40 °C ... +75 °C
Max. rel. humidity (not condensing)	≤ 95 %
Effect of air pressure	0.3 ppm/hPa
Effect of air temperature	-1 ppm/K
Temperature drift	Typ. 0.25 mm/K
Typ. Ambient light immunity	$\leq 100,000$ lx
Mechanical load	Shock: 30 g / 6 ms according to DIN EN 60068-2-27 (Ea), 6 axes Continuous shock: 25 g / 6 ms according to DIN EN 60068-2-27 (fatigue), 500 shocks, 6 axes

¹⁾ At a temperature of -40 °C, a warm-up time of typ. 20 minutes is required (when supply voltage $V_S = 24$ V).

Classifications

ECLASS 5.0	27270801
ECLASS 5.1.4	27270801
ECLASS 6.0	27270801
ECLASS 6.2	27270801
ECLASS 7.0	27270801
ECLASS 8.0	27270801
ECLASS 8.1	27270801
ECLASS 9.0	27270801
ECLASS 10.0	27270801
ECLASS 11.0	27270801
ECLASS 12.0	27270916
ETIM 5.0	EC001825
ETIM 6.0	EC001825
ETIM 7.0	EC001825
ETIM 8.0	EC001825
UNSPSC 16.0901	41111613

Dimensional drawing (Dimensions in mm (inch))

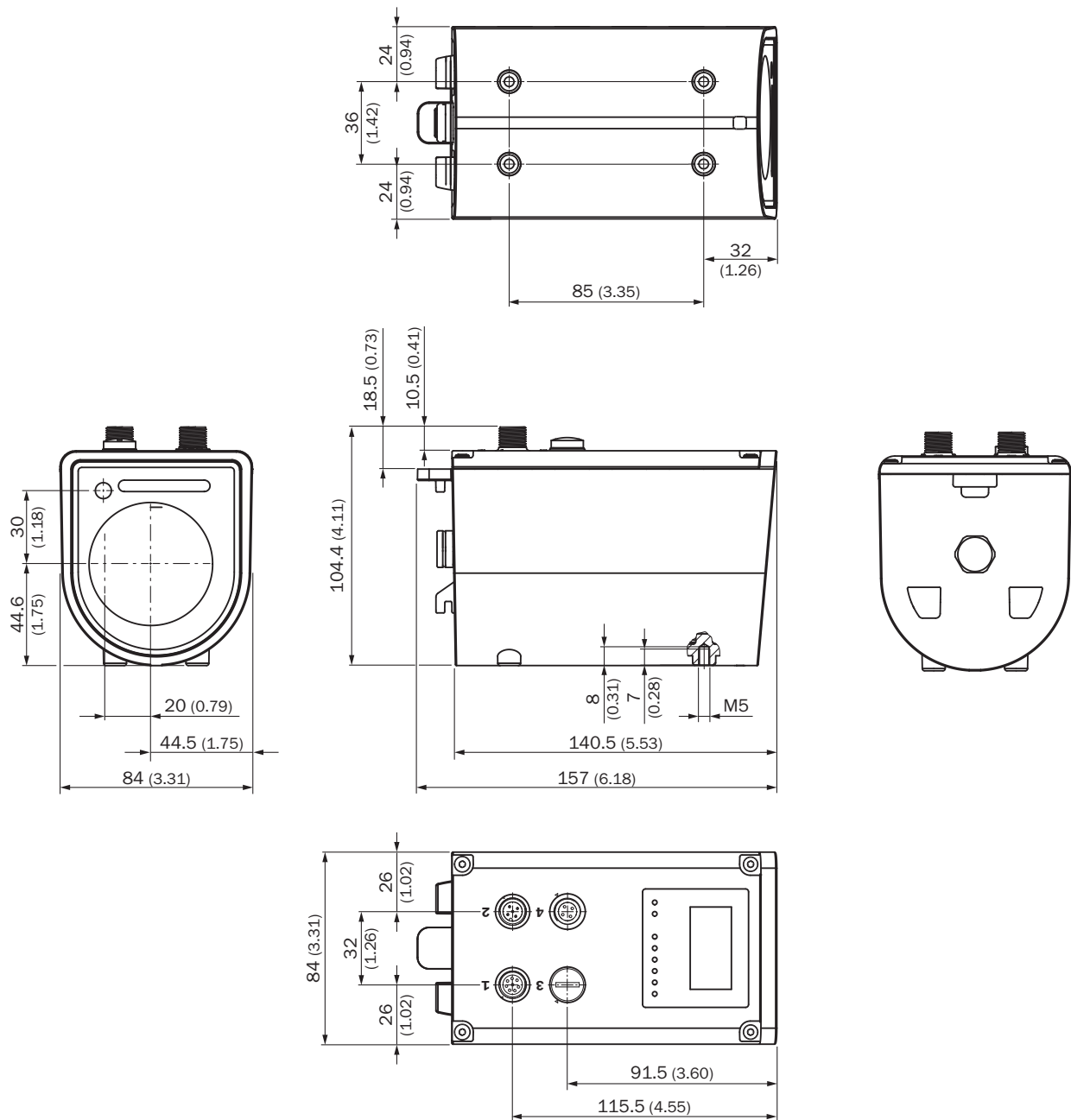

Working range diagram

DL1000 measuring range based on measurement cycle time and reflector type

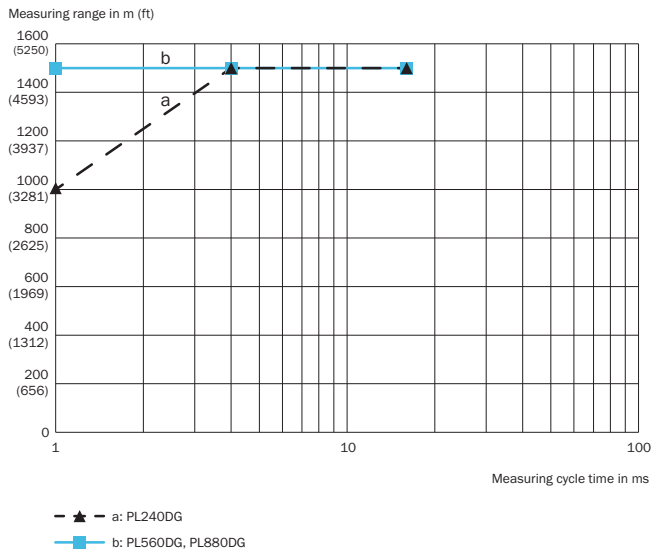

Connection type

Connection 2: Auxiliary

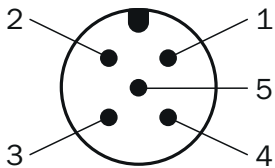

Connector M12, 5-pin, A-coded

- ① nc
- ② Q₃
- ③ nc
- ④ Q₄
- ⑤ In₂

PIN assignment

Connection 1: power, RS-422/SSI, Q1/In1, Q2/QA

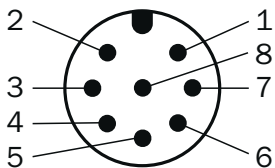

Connector M12, 8-pin, A-coded

- ① Q1/In1
- ② L+
- ③ RX-/CLK-
- ④ RX+/CLK+
- ⑤ TX-/Data-
- ⑥ TX+/Data+
- ⑦ M
- ⑧ Q₂/Q_A

Connection 4: Ethernet

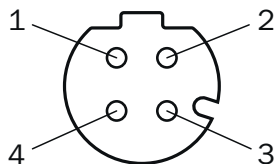

M12 female connector, 4-pin, D-coded

- ① TX+
- ② RX+
- ③ TX-
- ④ RX-

Light spot size

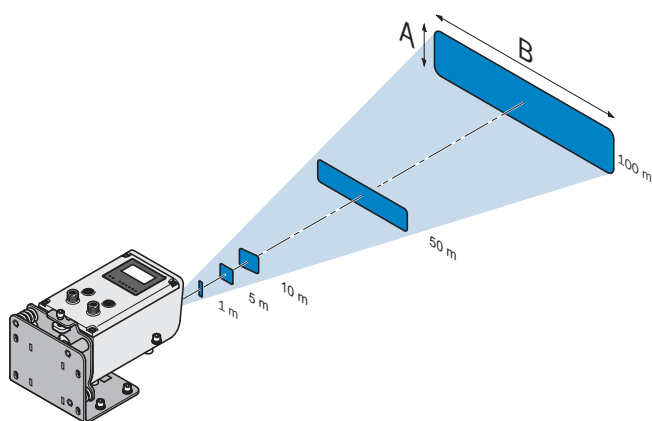

Functional principle

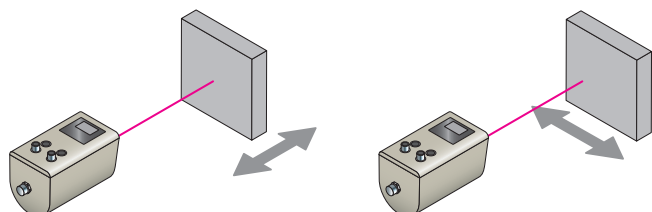

Repeatability

DL1000 for various reflector types, with 1 ms measurement cycle time

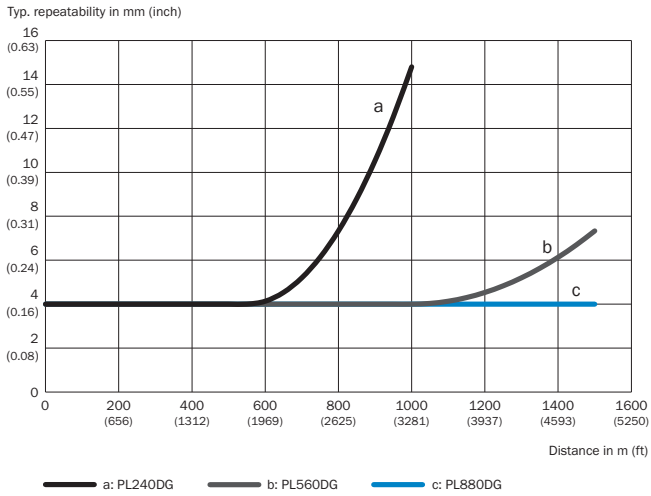

DL1000 for various reflector types, with 4 ms measurement cycle time

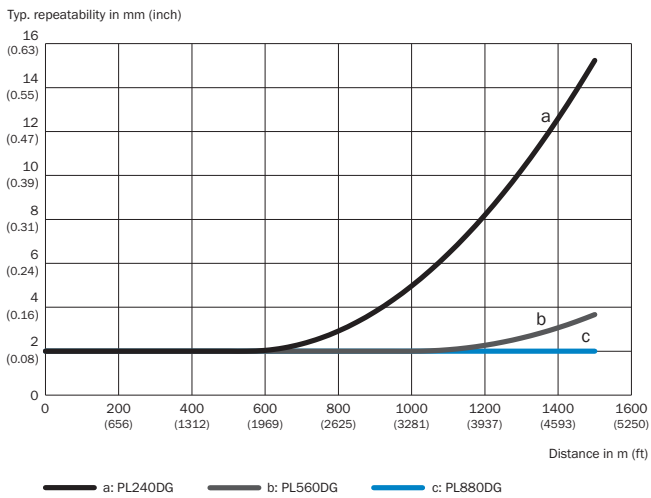

DL1000 for various reflector types, with 16 ms measurement cycle time

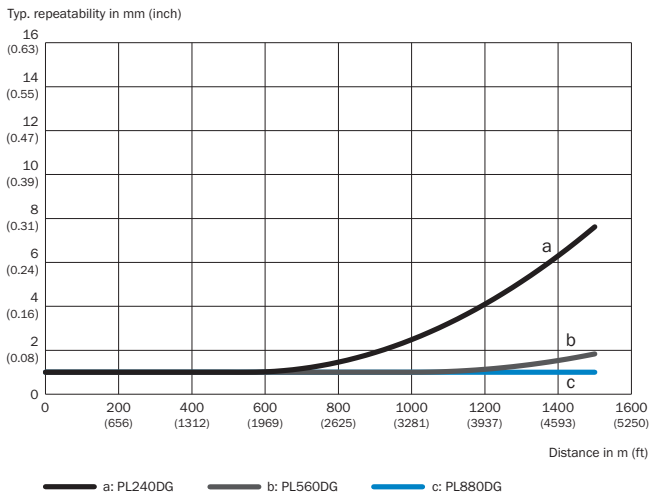

Measurement accuracy

Typically DL1000, x-axis: Distance, y-axis: Typical measurement accuracy

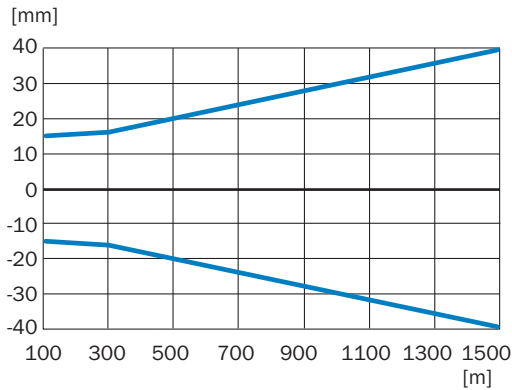



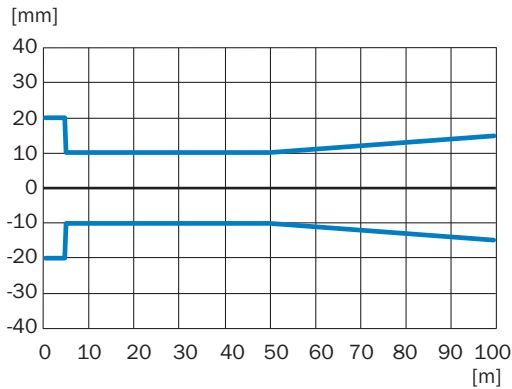

Typically DL1000, x-axis: Distance, y-axis: Typical measurement accuracy



Recommended accessories

Other models and accessories → www.sick.com/Dx1000

	Brief description	Type	Part no.
Device protection (mechanical)			
	Can be opened upward without tools. Conductor for connections on the back. Due to space constraints, connecting cables with 90° angled, pre-assembled male connectors/female connectors are required., Weatherproof housing (BEF-AH-DX1000, tube for weatherproof housing and rain cover for protective housing are not included with delivery)	Weatherproof housing	2087690
Reflectors			
	Reflector plate, "diamond grade" reflective tape, 665 mm x 665 mm, base plate material: aluminum, screw connection, Screw-on, 4 hole mounting	PL560DG	1016806
Terminal and alignment brackets			
	Alignment bracket for mounting and precise alignment of the sensor in a horizontal and vertical direction, stainless steel, mounting hardware included	BEF-AH-DX1000	2080392

	Brief description	Type	Part no.
Others			
	<ul style="list-style-type: none"> • Connection type head A: Female connector, M12, 8-pin, angled • Connection type head B: Flying leads • Signal type: RS-422, SSI • Cable: 10 m, 8-wire, PUR, halogen-free • Description: RS-422, SSI, shielded 	YG2A68-100XXXXLECX	6051482

SICK AT A GLANCE

SICK is one of the leading manufacturers of intelligent sensors and sensor solutions for industrial applications. A unique range of products and services creates the perfect basis for controlling processes securely and efficiently, protecting individuals from accidents and preventing damage to the environment.

We have extensive experience in a wide range of industries and understand their processes and requirements. With intelligent sensors, we can deliver exactly what our customers need. In application centers in Europe, Asia and North America, system solutions are tested and optimized in accordance with customer specifications. All this makes us a reliable supplier and development partner.

Comprehensive services complete our offering: SICK LifeTime Services provide support throughout the machine life cycle and ensure safety and productivity.

For us, that is “Sensor Intelligence.”

WORLDWIDE PRESENCE:

Contacts and other locations –www.sick.com