



DLS40E-BBAV00600

DLS40

INCREMENTAL ENCODERS

SICK
Sensor Intelligence.



Illustration may differ



Ordering information

Type	Part no.
DLS40E-BBAV00600	1128528

Other models and accessories → www.sick.com/DLS40

Detailed technical data

Safety-related parameters

MTTF_D (mean time to dangerous failure)	600 years (EN ISO 13849-1) ¹⁾
--	--

¹⁾ This product is a standard product and does not constitute a safety component as defined in the Machinery Directive. Calculation based on nominal load of components, average ambient temperature 40°C, frequency of use 8760 h/a. All electronic failures are considered hazardous. For more information, see document no. 8015532.

Performance

Pulses per revolution	600
Measuring step	90°, electric/pulses per revolution
Duty cycle	≤ 0.5 ± 10 %

Interfaces

Communication interface	Incremental
Communication Interface detail	TTL / RS-422
Number of signal channels	6-channel
Output frequency	≤ 150 kHz
Load current	≤ 30 mA
Power consumption	≤ 2 W (without load)

Electrical data

Connection type	Cable, 8-wire, radial, 2 m
Supply voltage	4.5 ... 5.5 V
Reference signal, number	1
Reverse polarity protection	✓
Short-circuit protection of the outputs	✓ ¹⁾

¹⁾ Protection against short circuit only to GND. Short-circuit resistance is only guaranteed when GND and U_S are connected correctly.

Mechanical data

Mechanical design	Blind hollow shaft
Shaft diameter	8 mm
Weight	Approx. 170 g ¹⁾

¹⁾ Relates to encoders with 2 m cable connection.

²⁾ Allow for self-heating of 1.3 K per 1,000 rpm when designing the operating temperature range.

³⁾ No permanent operation. Decreasing signal quality.

Shaft material	Stainless steel
Flange material	Aluminum
Housing material	Aluminum
Material, cable	PVC
Start up torque	0.5 Ncm
Operating torque	0.3 Ncm
Permissible movement static	± 0.3 mm (radial) ± 0.5 mm (axial)
Permissible movement dynamic	± 0.1 mm (radial) ± 0.2 mm (axial)
Operating speed	6,000 min ^{-1 2)}
Maximum operating speed	≤ 8,000 min ^{-1 3)}
Moment of inertia of the rotor	24.6 gcm ²
Bearing lifetime	2.0 x 10 ⁹ revolutions
Angular acceleration	≤ 500,000 rad/s ²

1) Relates to encoders with 2 m cable connection.

2) Allow for self-heating of 1.3 K per 1,000 rpm when designing the operating temperature range.

3) No permanent operation. Decreasing signal quality.

Ambient data

EMC	According to EN 61000-6-2 and EN 61000-6-3
Permissible relative humidity	90 % (Condensation not permitted)
Operating temperature range	-10 °C ... +70 °C
Storage temperature range	-25 °C ... +85 °C
Resistance to shocks	100 g, 6 ms (EN 60068-2-27)
Resistance to vibration	20 g, 10 Hz ... 2,000 Hz (EN 60068-2-6)

Classifications

ECLASS 5.0	27270501
ECLASS 5.1.4	27270501
ECLASS 6.0	27270590
ECLASS 6.2	27270590
ECLASS 7.0	27270501
ECLASS 8.0	27270501
ECLASS 8.1	27270501
ECLASS 9.0	27270501
ECLASS 10.0	27270501
ECLASS 11.0	27270501
ECLASS 12.0	27270501
ETIM 5.0	EC001486
ETIM 6.0	EC001486
ETIM 7.0	EC001486
ETIM 8.0	EC001486
UNSPSC 16.0901	41112113

Dimensional drawing (Dimensions in mm (inch))

Blind hollow shaft



- ① Start position of the Z-pulse
- ② 2x M4 threaded pin hex key screw size 2.0

Type Blind hollow shaft	Shaft diameter XF7
DLS40E-BAxxxxxxx	6 mm
DLS40E-BBxxxxxxx	8 mm
DLS40E-BDxxxxxxx	10 mm
DLS40E-BExxxxxxx	12 mm

PIN assignment

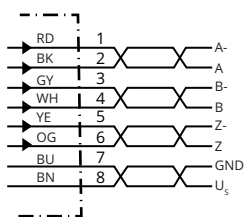

Wire colors (cable connection)	Signal	Description
Brown	U _s	Supply voltage

Wire colors (cable connection)	Signal	Description
Blue	GND	Ground connection
Black	A	Signal cable
White	B	Signal cable
Orange	Z	Signal cable
Red	A-	Signal cable
Gray	B-	Signal cable
Yellow	Z-	Signal cable

Diagrams

TTL / RS-422

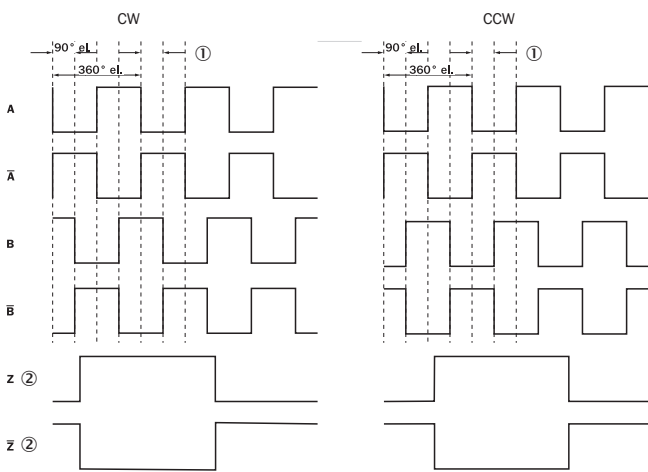

- ① Measuring step
- ② Only as reference

Operation note



You can see the position with the mark on the rear side of the encoder
① Zero pulse mark on housing

SICK AT A GLANCE

SICK is one of the leading manufacturers of intelligent sensors and sensor solutions for industrial applications. A unique range of products and services creates the perfect basis for controlling processes securely and efficiently, protecting individuals from accidents and preventing damage to the environment.

We have extensive experience in a wide range of industries and understand their processes and requirements. With intelligent sensors, we can deliver exactly what our customers need. In application centers in Europe, Asia and North America, system solutions are tested and optimized in accordance with customer specifications. All this makes us a reliable supplier and development partner.

Comprehensive services complete our offering: SICK LifeTime Services provide support throughout the machine life cycle and ensure safety and productivity.

For us, that is “Sensor Intelligence.”

WORLDWIDE PRESENCE:

Contacts and other locations –www.sick.com