



## DOL-0804-G25MRN

Sensor/actuator cable

**SICK**  
Sensor Intelligence.



## Ordering information

Type	Part no.
DOL-0804-G25MRN	6058513

Other models and accessories → [www.sick.com/Sensor\\_actuator\\_cable](http://www.sick.com/Sensor_actuator_cable)



## Detailed technical data

### Technical specifications

<b>Connection type head A</b>	Female connector, M8, 4-pin, straight				
<b>Connection type head B</b>	Flying leads				
<b>Connection type</b>	Flying leads				
<b>Connector material</b>	PP				
<b>Connector color</b>	Gray				
<b>Locking nut material</b>	Stainless steel (V4A/1.4404/316L)				
<b>Tightening torque</b>	0.6 Nm				
<b>Width across flats</b>	9				
<b>Cable</b>	25 m, 4-wire, PP				
<b>Jacket material</b>	pp <sup>1)</sup>				
<b>Jacket color</b>	Gray				
<b>Cable diameter</b>	4.6 mm				
<b>Conductor cross section</b>	0.34 mm <sup>2</sup>				
<b>Shielding</b>	Unshielded				
<b>Bending radius</b>	<table border="0"> <tr> <td style="padding-right: 20px;">Flexible use</td> <td>&gt; 10 x cable diameter</td> </tr> <tr> <td>Stationary position</td> <td>&gt; 5 x cable diameter</td> </tr> </table>	Flexible use	> 10 x cable diameter	Stationary position	> 5 x cable diameter
Flexible use	> 10 x cable diameter				
Stationary position	> 5 x cable diameter				
<b>Bending cycles</b>	≥ 4,000,000				
<b>Reference voltage</b>	≤ 30 V				
<b>Rated impulse voltage</b>	0.8 kV				
<b>Current loading</b>	4 A				
<b>Signal type</b>	Sensor/actuator cable				
<b>Torsion force</b>	180° / 1 m				
<b>Application</b>	Hygienic and washdown zones Drag chain operation				

<sup>1)</sup> Silicone-free, halogen-free, LABS-free.

<sup>2)</sup> Tested cleaning agents: 3% P3 – topax 990, 5% P3 – topoactive 200, 5% P3 – topax 52, 3% P3 – topax 66, 3% P3 – topoactive OKTO; Insulating material group: Cat I.

<b>Note</b>	This product is generally resistant to chemical cleaning agents (see ECOLAB) and other chemical compounds such as H2O2 and CH2O2. Before permanent installation is carried out, the material's resistance to the cleaning agent being used must be checked. Resistant against lactic acid & hydrogen peroxide (H2O2) <sup>2)</sup>
<b>Authorizations</b>	Ecolab
<b>Enclosure rating</b>	IP67/ IP69K
<b>Operating temperature</b>	
Flexible use	-25 °C ... +105 °C
Stationary position	-40 °C ... +105 °C

<sup>1)</sup> Silicone-free, halogen-free, LABS-free.

<sup>2)</sup> Tested cleaning agents: 3% P3 - topax 990, 5% P3 - topoactive 200, 5% P3 - topax 52, 3% P3 - topax 66, 3% P3 - topactive OKTO; Insulating material group: Cat I.

### Classifications

<b>ECLASS 5.0</b>	19030312
<b>ECLASS 5.1.4</b>	19030312
<b>ECLASS 6.0</b>	27060304
<b>ECLASS 6.2</b>	27060304
<b>ECLASS 7.0</b>	27060304
<b>ECLASS 8.0</b>	27060304
<b>ECLASS 8.1</b>	27060304
<b>ECLASS 9.0</b>	27060304
<b>ECLASS 10.0</b>	27060304
<b>ECLASS 11.0</b>	27060304
<b>ECLASS 12.0</b>	27060304
<b>ETIM 5.0</b>	EC000830
<b>ETIM 6.0</b>	EC000830
<b>ETIM 7.0</b>	EC003249
<b>ETIM 8.0</b>	EC003249
<b>UNSPSC 16.0901</b>	26121604

Dimensional drawing (Dimensions in mm (inch))

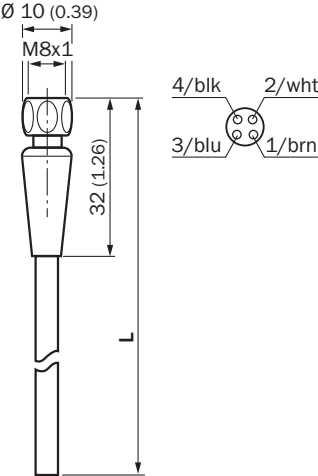

## SICK AT A GLANCE

SICK is one of the leading manufacturers of intelligent sensors and sensor solutions for industrial applications. A unique range of products and services creates the perfect basis for controlling processes securely and efficiently, protecting individuals from accidents and preventing damage to the environment.

We have extensive experience in a wide range of industries and understand their processes and requirements. With intelligent sensors, we can deliver exactly what our customers need. In application centers in Europe, Asia and North America, system solutions are tested and optimized in accordance with customer specifications. All this makes us a reliable supplier and development partner.

Comprehensive services complete our offering: SICK LifeTime Services provide support throughout the machine life cycle and ensure safety and productivity.

For us, that is “Sensor Intelligence.”

## WORLDWIDE PRESENCE:

Contacts and other locations –[www.sick.com](http://www.sick.com)