



DOL-1204-W05MRN

Sensor/actuator cable

SICK
Sensor Intelligence.



Ordering information

Type	Part no.
DOL-1204-W05MRN	6058477

Other models and accessories → www.sick.com/Sensor_actuator_cable



Detailed technical data

Technical specifications

Connection type head A	Female connector, M12, 4-pin, angled				
Connection type head B	Flying leads				
Connection type	Flying leads				
Connector material	PP				
Connector color	Gray				
Locking nut material	Stainless steel (V4A/1.4404)				
Tightening torque	1 Nm				
Width across flats	14				
Cable	5 m, 4-wire, PP				
Jacket material	pp ¹⁾				
Jacket color	Gray				
Cable diameter	4.6 mm				
Conductor cross section	0.34 mm ²				
Shielding	Unshielded				
Bending radius	<table border="0"> <tr> <td style="padding-right: 20px;">Flexible use</td> <td>> 10 x cable diameter</td> </tr> <tr> <td>Stationary position</td> <td>> 5 x cable diameter</td> </tr> </table>	Flexible use	> 10 x cable diameter	Stationary position	> 5 x cable diameter
Flexible use	> 10 x cable diameter				
Stationary position	> 5 x cable diameter				
Bending cycles	≥ 4,000,000				
Reference voltage	≤ 250 V				
Rated impulse voltage	2.5 kV				
Current loading	4 A				
Signal type	Sensor/actuator cable				
Torsion force	180° / 1 m				
Application	Hygienic and washdown zones Drag chain operation				

¹⁾ Silicone-free, halogen-free, LABS-free.

²⁾ Tested cleaning agents: 3% P3 – topax 990, 5% P3 – topoactive 200, 5% P3 – topax 52, 3% P3 – topax 66, 3% P3 – topactive OKTO; Insulating material group: Cat I.

Note	This product is generally resistant to chemical cleaning agents (see ECOLAB) and other chemical compounds such as H ₂ O ₂ and CH ₂ O ₂ . Before permanent installation is carried out, the material's resistance to the cleaning agent being used must be checked. Resistant against lactic acid & hydrogen peroxide (H ₂ O ₂) ²⁾
Authorizations	Ecolab
Enclosure rating	IP67/ IP69K
Operating temperature	
Flexible use	-25 °C ... +105 °C
Stationary position	-40 °C ... +105 °C

¹⁾ Silicone-free, halogen-free, LABS-free.

²⁾ Tested cleaning agents: 3% P3 - topax 990, 5% P3 - topoactive 200, 5% P3 - topax 52, 3% P3 - topax 66, 3% P3 - topactive OKTO; Insulating material group: Cat I.

Classifications

ECLASS 5.0	19030312
ECLASS 5.1.4	19030312
ECLASS 6.0	27060304
ECLASS 6.2	27060304
ECLASS 7.0	27060304
ECLASS 8.0	27060304
ECLASS 8.1	27060304
ECLASS 9.0	27060304
ECLASS 10.0	27060304
ECLASS 11.0	27060304
ECLASS 12.0	27060304
ETIM 5.0	EC000830
ETIM 6.0	EC000830
ETIM 7.0	EC003249
ETIM 8.0	EC003249
UNSPSC 16.0901	26121604

Dimensional drawing (Dimensions in mm (inch))

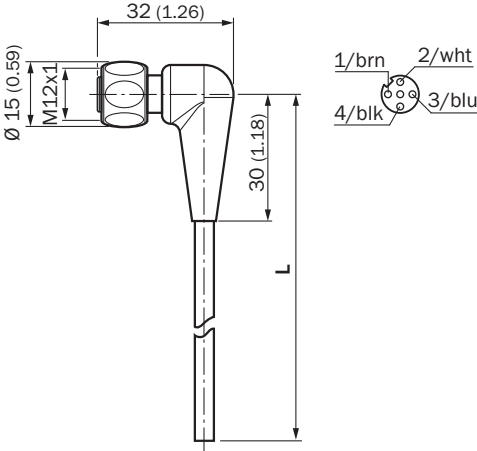

SICK AT A GLANCE

SICK is one of the leading manufacturers of intelligent sensors and sensor solutions for industrial applications. A unique range of products and services creates the perfect basis for controlling processes securely and efficiently, protecting individuals from accidents and preventing damage to the environment.

We have extensive experience in a wide range of industries and understand their processes and requirements. With intelligent sensors, we can deliver exactly what our customers need. In application centers in Europe, Asia and North America, system solutions are tested and optimized in accordance with customer specifications. All this makes us a reliable supplier and development partner.

Comprehensive services complete our offering: SICK LifeTime Services provide support throughout the machine life cycle and ensure safety and productivity.

For us, that is “Sensor Intelligence.”

WORLDWIDE PRESENCE:

Contacts and other locations –www.sick.com