



DS35-B15521

Dx35

MID RANGE DISTANCE SENSORS

SICK
Sensor Intelligence.



Ordering information

Type	Part no.
DS35-B15521	1057654

Other models and accessories → www.sick.com/Dx35



Detailed technical data

Features

Measuring range	50 mm ... 12,000 mm, 90% remission factor ^{1) 2)} 50 mm ... 5,300 mm, 18 % remission 50 mm ... 3,100 mm, 6% remission factor
Target	Natural objects
Resolution	0.1 mm
Repeatability	≥ 0.5 mm ^{2) 3)}
Measurement accuracy	Typ. ± 10 mm ⁴⁾
Response time	4.5 ms ... 192.5 ms, 4.5 ms / 12.5 ms / 24.5 ms / 48.5 ms / 192.5 ms ^{5) 6)}
Switching frequency	166 Hz/50 Hz/25 Hz/12 Hz/3 Hz ^{5) 6)}
Output time	2 ms ... 64 ms, 2 ms/4 ms/8 ms/16 ms/64 ms ^{5) 7)}
Light source	Laser, red ⁸⁾ visible red light
Type of light	Visible red light
Laser class	1 (IEC 60825-1:2014, EN 60825-1:2014)
Typ. light spot size (distance)	15 mm x 15 mm (at 2 m)
Additional function	Set speed: Super Fast ... Super Slow Switching mode: Distance to Object (DtO) / switching window / object between sensor and background (ObSB)

¹⁾ For speed setting Slow.

²⁾ See repeatability characteristic lines.

³⁾ Equivalent to 1 σ .

⁴⁾ 6% ... 90% remission factor.

⁵⁾ Depending on the set speed: Super Fast ... Super Slow.

⁶⁾ Lateral entry of the object into the measuring range.

⁷⁾ Continuous change of distance in measuring range.

⁸⁾ Wavelength: 658 nm; max. output: 250 mW; pulse duration: 4 ns; duty cycle: 1/500.

	Teach-in of digital output and digital output invertible Multifunctional input: laser off / external teach / deactivated Reset to factory default
Average laser service life (at 25 °C)	100,000 h
Safety-related parameters	
	MTTF _D 101 years
	DC _{avg} 0%

- 1) For speed setting Slow.
- 2) See repeatability characteristic lines.
- 3) Equivalent to 1 σ .
- 4) 6% ... 90% remission factor.
- 5) Depending on the set speed: Super Fast ... Super Slow.
- 6) Lateral entry of the object into the measuring range.
- 7) Continuous change of distance in measuring range.
- 8) Wavelength: 658 nm; max. output: 250 mW; pulse duration: 4 ns; duty cycle: 1/500.

Interfaces

IO-Link	✓, IO-Link V1.1
Function	Process data, parameterization, diagnosis
Data transmission rate	38.4 kbit/s
Digital output	
Number	2 ^{1) 2)}
Type	Push-pull: PNP/NPN
Function	Output Q ₂ , adaptable: digital output/Q ₁ not/deactivated
Maximum output current I _A	≤ 100 mA
Multifunctional input (MF)	1 x ³⁾
Hysteresis	0 mm ... 11,950 mm ⁴⁾

- 1) Output Q short-circuit protected.
- 2) Voltage drop < 3 V.
- 3) Response time ≤ 60 ms.
- 4) Configurable via IO-Link.

Electronics

Supply voltage U_B	DC 12 V ... 30 V ^{1) 2)}
Power consumption	≤ 1.7 W ³⁾
Ripple	≤ 5 V _{pp} ⁴⁾
Initialization time	≤ 500 ms
Warm-up time	≤ 20 min
Indication	LEDs
Enclosure rating	IP65 IP67
Protection class	III

- 1) Limit values, reverse-polarity protected, operation in short-circuit protected network: max. 8 A.
- 2) When using IO-Link output V_S > 18 V.
- 3) Without load, at +20 °C.
- 4) May not fall short of or exceed V_S tolerances.

Mechanics

Dimensions (W x H x D)	32 mm x 58.67 mm x 42.7 mm
Housing material	Plastic (ABS/PC)
Window material	Plastic (PMMA)
Weight	65 g
Connection type	Male connector, M12, 5-pin

Ambient data

Ambient temperature, operation	-30 °C ... +55 °C, $U_v \leq 24$ V
Ambient temperature, storage	-40 °C ... +75 °C
Max. rel. humidity (not condensing)	≤ 95 %
Vibration resistance	EN 60068-2-6, EN 60068-2-64
Shock resistance	EN 60068-2-27
Electromagnetic compatibility (EMC)	EN 61000-6-2, EN 61000-6-3, EN 61000-6-4 ¹⁾

¹⁾ This is a Class A device. This device can cause radio interference in living quarters.

Classifications

ECLASS 5.0	27270801
ECLASS 5.1.4	27270801
ECLASS 6.0	27270801
ECLASS 6.2	27270801
ECLASS 7.0	27270801
ECLASS 8.0	27270801
ECLASS 8.1	27270801
ECLASS 9.0	27270801
ECLASS 10.0	27270801
ECLASS 11.0	27270801
ECLASS 12.0	27270916
ETIM 5.0	EC001825
ETIM 6.0	EC001825
ETIM 7.0	EC001825
ETIM 8.0	EC001825
UNSPSC 16.0901	41111613

Dimensional drawing (Dimensions in mm (inch))

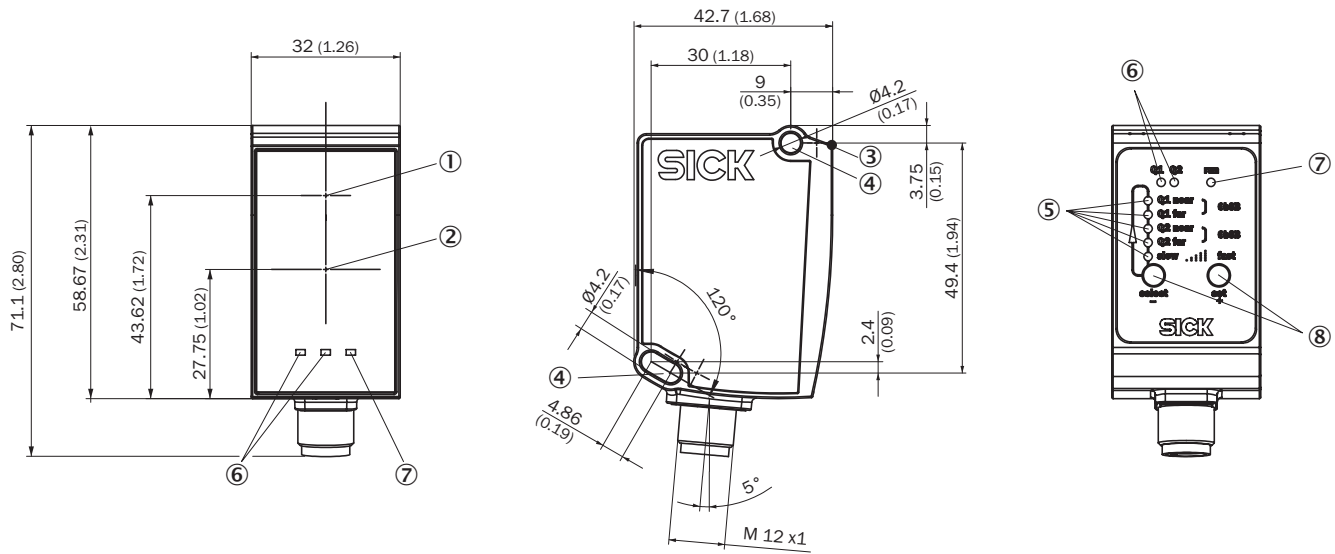

- ① Optical axis, sender
- ② Optical axis, receiver
- ③ Zero level
- ④ Mounting hole M4
- ⑤ Status indicator output Qa/Q2
- ⑥ Status LEDs output Q1
- ⑦ Operating indicator
- ⑧ Control elements

Connection type

Male connector M12, 5-pin

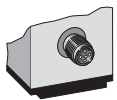

Connection diagram

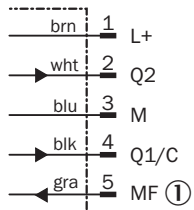

- ① Multifunctional input (MF)

Repeatability

Characteristic curve 1) Super Slow

Super Slow

Repeatability in mm (inch)

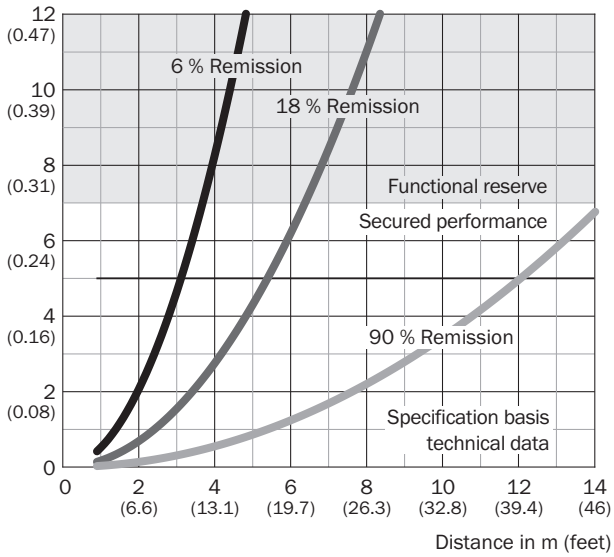

Characteristic curve 5) Super Fast

Super Fast

Repeatability in mm (inch)

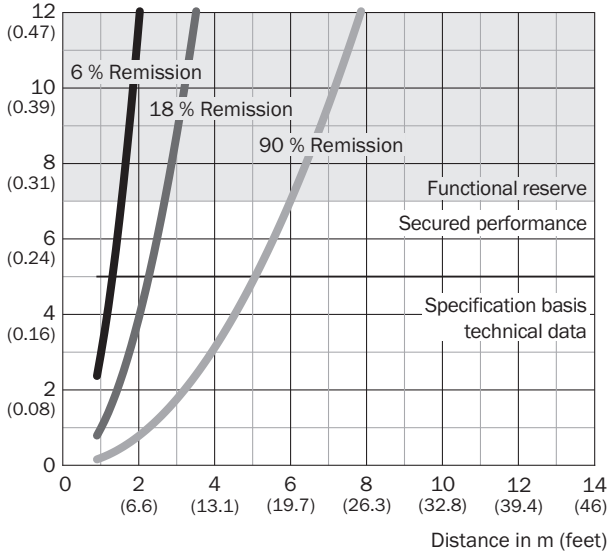

Characteristic curve 2) Slow

Slow

Repeatability in mm (inch)

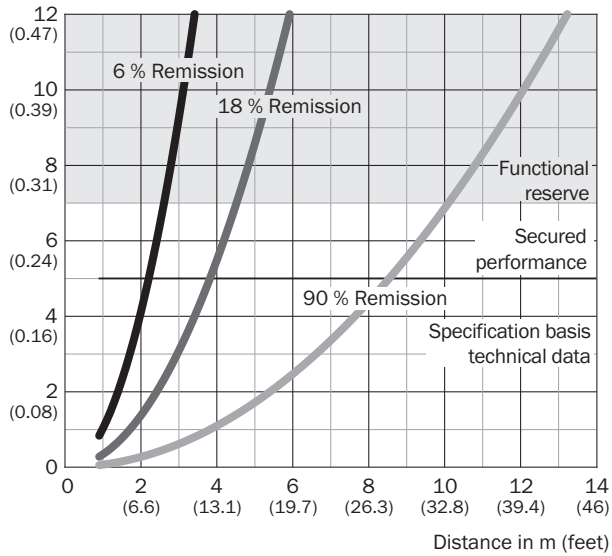

Characteristic curve 3) Medium

Medium

Repeatability in mm (inch)

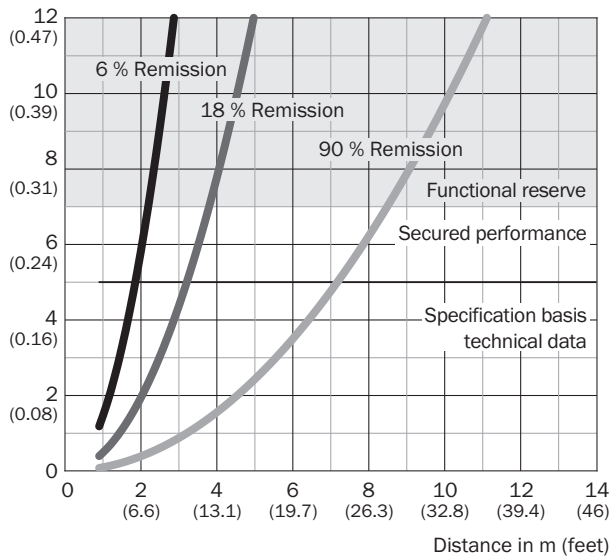

Characteristic curve 4) Fast



Fast

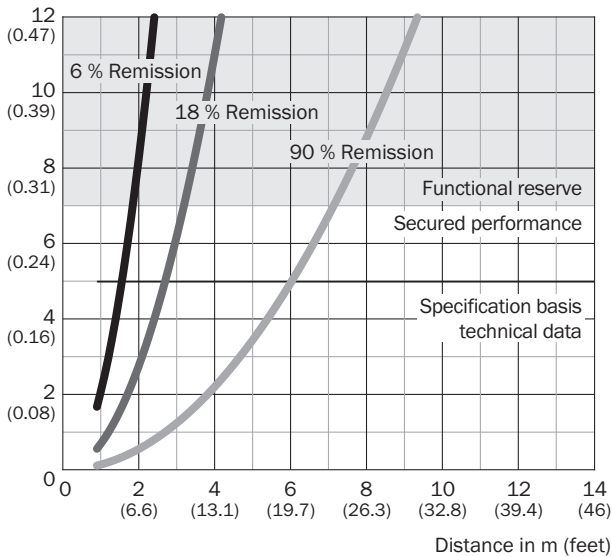

Repeatability in mm (inch)



Recommended accessories

Other models and accessories → www.sick.com/Dx35

	Brief description	Type	Part no.
Universal bar clamp systems			
	<ul style="list-style-type: none"> Description: Plate N02 for universal clamp bracket Material: Steel, zinc diecast Details: Zinc plated steel (sheet), Zinc die cast (clamping bracket) Items supplied: Universal clamp (5322626), mounting hardware Usable for: W4S-3 Glass, W10, W4SLG-3, W4S-3 Inox, W4S-3 Inox Glass, W9, W11-2, W12-3, W12-2 Laser, W12G, W12 Teflon, W16, W250, W250-2, PowerProx, W11G-2, TranspaTect, WTT12, UC12, P250, G6 Inox, W4S, W4SL-3V, W4SLG-3V, W4SL-3H 	BEF-KHS-N02	2051608
Mounting brackets and plates			
	<ul style="list-style-type: none"> Description: Mounting bracket: horizontal sending axis for ceiling or floor installation or vertical sending axis for wall installation, steel, zinc coated, incl. mounting material Material: Steel Details: Steel, zinc coated Items supplied: Mounting hardware for the sensor included 	BEF-WN-DX35	2069592
Terminal and alignment brackets			
	<ul style="list-style-type: none"> Description: Alignment unit Material: Steel Details: Steel, zinc coated Items supplied: Mounting hardware for the sensor included 	BEF-AH-DX50	2048397

	Brief description	Type	Part no.
Others			
	<ul style="list-style-type: none"> • Connection type head A: Female connector, M12, 5-pin, straight, A-coded • Connection type head B: Male connector, M12, 5-pin, straight, A-coded • Signal type: Sensor/actuator cable • Cable: 2 m, 5-wire, PUR, halogen-free • Description: Sensor/actuator cable, unshielded • Application: Uncontaminated zones, Zones with oils and lubricants, Robot, Drag chain operation 	YF2A15-020UB5M2A15	2096009
	<ul style="list-style-type: none"> • Connection type head A: Female connector, M12, 5-pin, angled, A-coded • Connection type head B: Flying leads • Signal type: Sensor/actuator cable • Cable: 2 m, 5-wire, PVC • Description: Sensor/actuator cable, unshielded • Application: Zones with chemicals, Uncontaminated zones 	YG2A15-020VB5XLEAX	2096215
	<ul style="list-style-type: none"> • Connection type head A: Female connector, M12, 5-pin, straight, A-coded • Connection type head B: Flying leads • Signal type: Sensor/actuator cable • Cable: 2 m, 5-wire, PVC • Description: Sensor/actuator cable, unshielded • Application: Zones with chemicals, Uncontaminated zones 	YF2A15-020VB5XLEAX	2096239

SICK AT A GLANCE

SICK is one of the leading manufacturers of intelligent sensors and sensor solutions for industrial applications. A unique range of products and services creates the perfect basis for controlling processes securely and efficiently, protecting individuals from accidents and preventing damage to the environment.

We have extensive experience in a wide range of industries and understand their processes and requirements. With intelligent sensors, we can deliver exactly what our customers need. In application centers in Europe, Asia and North America, system solutions are tested and optimized in accordance with customer specifications. All this makes us a reliable supplier and development partner.

Comprehensive services complete our offering: SICK LifeTime Services provide support throughout the machine life cycle and ensure safety and productivity.

For us, that is “Sensor Intelligence.”

WORLDWIDE PRESENCE:

Contacts and other locations –www.sick.com