



# DT1000-S11102

Dx1000

**LONG RANGE DISTANCE SENSORS**

**SICK**  
Sensor Intelligence.

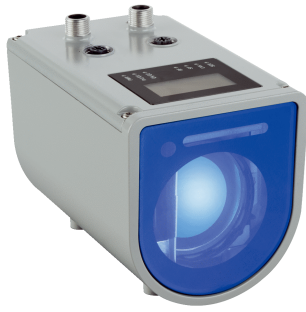

### Ordering information

Type	Part no.
DT1000-S11102	1075437

Other models and accessories → [www.sick.com/Dx1000](http://www.sick.com/Dx1000)



### Detailed technical data

#### Features

<b>Measurement principle</b>	HDDM <sup>+</sup>
<b>Measuring range</b>	0.2 m ... 155 m, 6% remission factor <sup>1) 2) 3)</sup> 0.2 m ... 460 m, 90% remission factor <sup>1) 2) 3)</sup>
<b>Target</b>	Natural objects
<b>Resolution</b>	0.001 mm ... 100 mm, adjustable <sup>4)</sup>
<b>Repeatability</b>	≥ 1 mm, See repeatability characteristic lines <sup>1) 5) 6) 7)</sup>
<b>Measurement accuracy</b>	Typ. ± 15 mm <sup>8) 9)</sup>
<b>Response time</b>	3 ms ... 384 ms <sup>7)</sup>
<b>Measurement cycle time</b>	1 ms 4 ms 16 ms 64 ms 128 ms
<b>Output time</b>	≥ 1 ms <sup>10)</sup>
<b>Light source</b>	Infrared light (905 nm, measuring laser) Visible red light (650 nm, Adjustment aid)

<sup>1)</sup> With max. ambient light 100 kLux sunlight.

<sup>2)</sup> See measuring range diagram.

<sup>3)</sup> Dependent on remission and measuring cycle time.

<sup>4)</sup> Data interface resolution.

<sup>5)</sup> Statistical error 1  $\sigma$ , environmental conditions constant, min. warm-up time > about 15 min.

<sup>6)</sup> 6% ... 90% remission factor.

<sup>7)</sup> Dependent on selected filter settings and measuring cycle time.

<sup>8)</sup> See measurement accuracy diagram.

<sup>9)</sup> At T = +23 °C and after warm-up time > about 15 min.

<sup>10)</sup> Depending on interface used.

<sup>11)</sup> See light spot size diagram.

<sup>12)</sup> For object temperatures > +1,200 °C, the use of the additional filter is required for high-temperature applications. The additional filter reduces the measuring range limit by approx. 25%.

<sup>13)</sup> Measuring laser.

<b>Laser class</b>	1, even with simultaneous operation of measurement and alignment laser (IEC 60825-1:2014, EN 60825-1:2014)
<b>Typ. light spot size (distance)</b>	5 mm x 20 mm (at 1 m) <sup>11)</sup> 20 mm x 20 mm (at 5 m) <sup>11)</sup> 35 mm x 25 mm (at 10 m) <sup>11)</sup> 150 mm x 50 mm (at 50 m) <sup>11)</sup> 290 mm x 80 mm (at 100 m) <sup>11)</sup> 570 mm x 140 mm (at 200 m) <sup>11)</sup>
<b>Filter</b>	Rain and snow filter Fog filter Moving average distance value Kalman filter Moving average speed value
<b>Max. object temperature</b>	+1,400 °C <sup>12)</sup>
<b>Additional function</b>	Selection of relevant distance and signal level range Selection of first or last echo in selected distance and signal level range
<b>Average laser service life (at 25 °C)</b>	100,000 h <sup>13)</sup>
<b>Max. movement speed</b>	128 m/s
<b>Safety-related parameters</b>	
	MTTF <sub>D</sub> 101 years
	DC <sub>avg</sub> 0%

<sup>1)</sup> With max. ambient light 100 kLux sunlight.

<sup>2)</sup> See measuring range diagram.

<sup>3)</sup> Dependent on remission and measuring cycle time.

<sup>4)</sup> Data interface resolution.

<sup>5)</sup> Statistical error 1  $\sigma$ , environmental conditions constant, min. warm-up time > about 15 min.

<sup>6)</sup> 6% ... 90% remission factor.

<sup>7)</sup> Dependent on selected filter settings and measuring cycle time.

<sup>8)</sup> See measurement accuracy diagram.

<sup>9)</sup> At T = +23 °C and after warm-up time > about 15 min.

<sup>10)</sup> Depending on interface used.

<sup>11)</sup> See light spot size diagram.

<sup>12)</sup> For object temperatures > +1,200 °C, the use of the additional filter is required for high-temperature applications. The additional filter reduces the measuring range limit by approx. 25%.

<sup>13)</sup> Measuring laser.

## Interfaces

<b>Ethernet</b>	✓, TCP/IP
Function	Parameterization, output of measurement data
Data transmission rate	10/100 MBit/s
<b>PROFIBUS DP</b>	✓
Function	Parameterization, output of measurement data
Data transmission rate	9.6 kBaud ... 12 MBaud, Automatic detection
<b>Serial</b>	✓, RS-422
Remark	Switchable to SSI
Function	Parameterization, output of measurement data
<b>SSI</b>	✓

<sup>1)</sup> Short-circuit protected, switching voltage  $U_V$  - 4 V.

<sup>2)</sup> Internal pull-down switching, switching voltage HIGH: min. 13 V ... max. supply voltage, switching voltage LOW: max. 5 V.

<sup>3)</sup> Max. load =  $(U_V - 7 V) / 21.5 \text{ mA}$ .

	Remark	Switchable to RS-422
	Function	Output of measurement data
<b>Inputs/outputs</b>		
	In1/Q1	Digital input, digital output (Switchable)
	QA/Q2	Analog output, digital output (Switchable)
<b>Digital input</b>		Internal pull-down circuit HIGH switching voltage: min. 13 V ... max. supply voltage LOW switching voltage: max. 5 V switching functions: deactivate measuring laser, activate alignment laser, preset
<b>Digital output</b>		
	Number	0 ... 2 <sup>1) 2)</sup>
	Type	Push-pull: PNP/NPN
	Maximum output current I <sub>A</sub>	≤ 100 mA
<b>Analog output</b>		
	Number	1
	Type	Current output
	Current	4 mA ... 20 mA <sup>3)</sup>
	Resolution	16 bit

<sup>1)</sup> Short-circuit protected, switching voltage U<sub>V</sub> - 4 V.

<sup>2)</sup> Internal pull-down switching, switching voltage HIGH: min. 13 V ... max. supply voltage, switching voltage LOW: max. 5 V.

<sup>3)</sup> Max. load = (U<sub>V</sub> - 7 V) / 21.5 mA.

## Electronics

<b>Supply voltage U<sub>B</sub></b>	DC 18 V ... 30 V, reverse polarity protected
<b>Power consumption</b>	≤ 22 W, With heating switched off <sup>1)</sup> ≤ 35 W, With heating switched on <sup>1)</sup>
<b>Ripple</b>	≤ 5 V <sub>pp</sub> <sup>2)</sup>
<b>Initialization time</b>	> 30 s
<b>Indication</b>	Graphical, resistive touch display, status LEDs
<b>Enclosure rating</b>	IP65 <sup>3)</sup> IP67 <sup>3)</sup>
<b>Protection class</b>	III (EN 61140)

<sup>1)</sup> With external load.

<sup>2)</sup> May not fall short of or exceed V<sub>S</sub> tolerances.

<sup>3)</sup> When plugged in with a suitable mating connector.

## Mechanics

<b>Dimensions (W x H x D)</b>	84 mm x 104.4 mm x 140.5 mm
<b>Housing material</b>	Metal (Aluminum alloy (AlSi12))
<b>Window material</b>	Glass
<b>Weight</b>	1,000 g
<b>Connection type</b>	Round connector M12 x 1

## Ambient data

<b>Ambient temperature, operation</b>	-40 °C ... +55 °C <sup>1)</sup>
---------------------------------------	---------------------------------

<sup>1)</sup> At a temperature of -40 °C, a warm-up time of typ. 20 minutes is required (when supply voltage V<sub>S</sub> = 24 V).

	-40 °C ... +95 °C, operation with cooling case
<b>Ambient temperature, storage</b>	-40 °C ... +75 °C
<b>Max. rel. humidity (not condensing)</b>	≤ 95 %
<b>Effect of air pressure</b>	0.3 ppm/hPa
<b>Effect of air temperature</b>	-1 ppm/K
<b>Temperature drift</b>	Typ. 0.25 mm/K
<b>Typ. Ambient light immunity</b>	≤ 100,000 lx
<b>Mechanical load</b>	Shock: 30 g / 6 ms according to DIN EN 60068-2-27 (Ea), 6 axes Continuous shock: 25 g / 6 ms according to DIN EN 60068-2-27 (fatigue), 500 shocks, 6 axes

<sup>1)</sup> At a temperature of -40 °C, a warm-up time of typ. 20 minutes is required (when supply voltage  $V_s = 24$  V).

## Classifications

<b>ECLASS 5.0</b>	27270801
<b>ECLASS 5.1.4</b>	27270801
<b>ECLASS 6.0</b>	27270801
<b>ECLASS 6.2</b>	27270801
<b>ECLASS 7.0</b>	27270801
<b>ECLASS 8.0</b>	27270801
<b>ECLASS 8.1</b>	27270801
<b>ECLASS 9.0</b>	27270801
<b>ECLASS 10.0</b>	27270801
<b>ECLASS 11.0</b>	27270801
<b>ECLASS 12.0</b>	27270916
<b>ETIM 5.0</b>	EC001825
<b>ETIM 6.0</b>	EC001825
<b>ETIM 7.0</b>	EC001825
<b>ETIM 8.0</b>	EC001825
<b>UNSPSC 16.0901</b>	41111613

# DT1000-S11102 | Dx1000

## LONG RANGE DISTANCE SENSORS

Dimensional drawing (Dimensions in mm (inch))

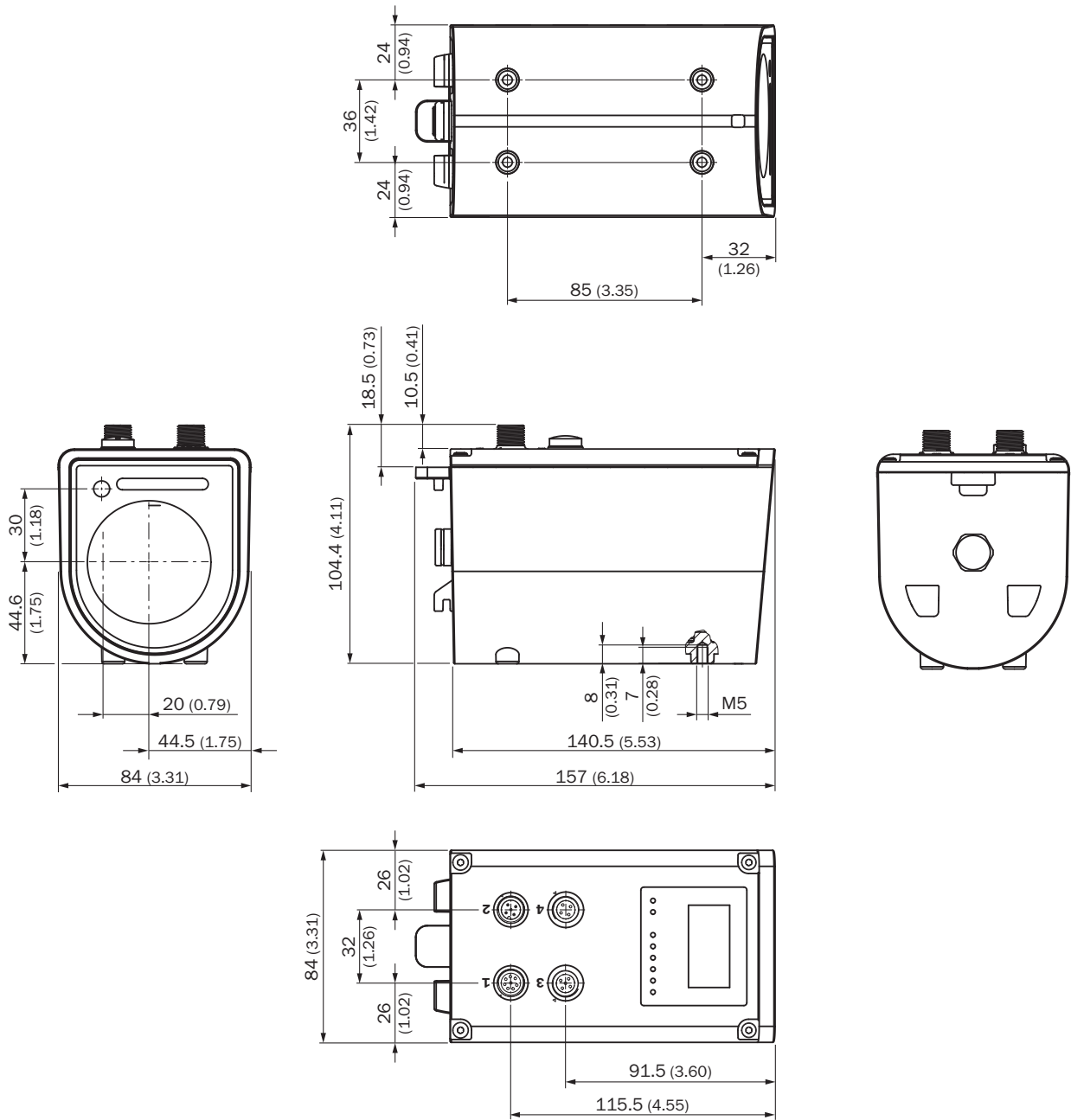

## Working range diagram

DT1000 measuring range based on measurement cycle time and object remission

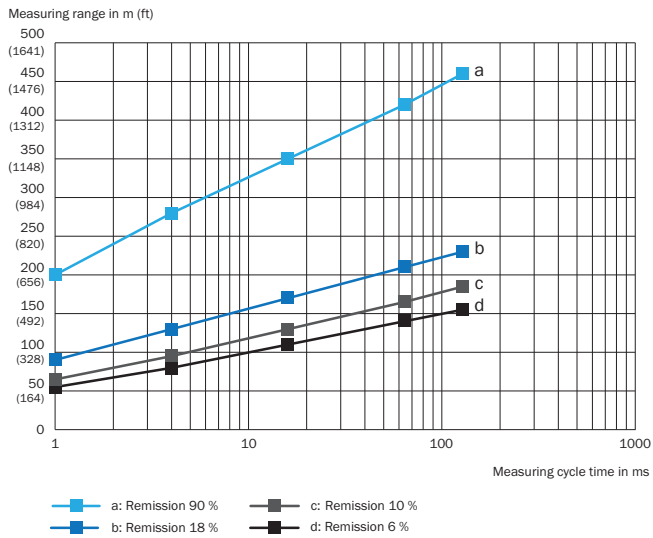

## PIN assignment

Connection 2: PROFIBUS In

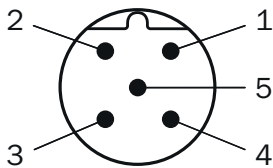

Connector M12, 5-pin, B-coded, BUS IN

- ① nc
- ② A
- ③ nc
- ④ B
- ⑤ nc

Connection 3: PROFIBUS Out

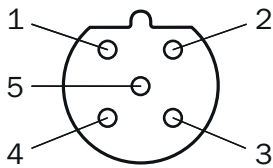

Female connector M12, 5-pin, B-coded

- ① +5 V
- ② A
- ③ GND
- ④ B
- ⑤ nc

Connection 1: power, RS-422/SSI, Q1/In1, Q2/QA

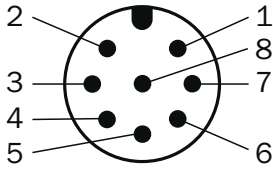

Connector M12, 8-pin, A-coded

- ① Q1/In1
- ② L+
- ③ RX-/CLK-
- ④ RX+/CLK+
- ⑤ TX-/Data-
- ⑥ TX+/Data+
- ⑦ M
- ⑧ Q2/QA

Connection 4: Ethernet

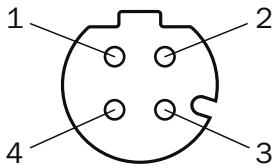

M12 female connector, 4-pin, D-coded

- ① TX+
- ② RX+
- ③ TX-
- ④ RX-

### Light spot size

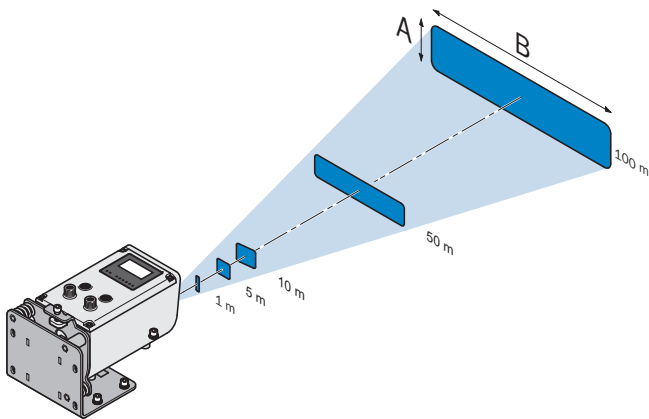



## Functional principle

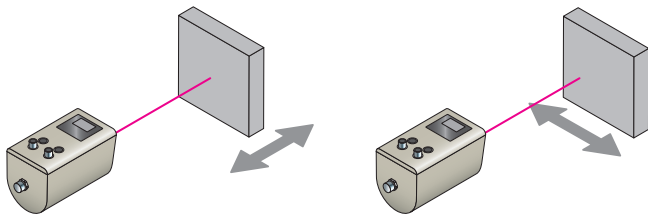

## Repeatability

DT1000, with 64 ms measurement cycle time

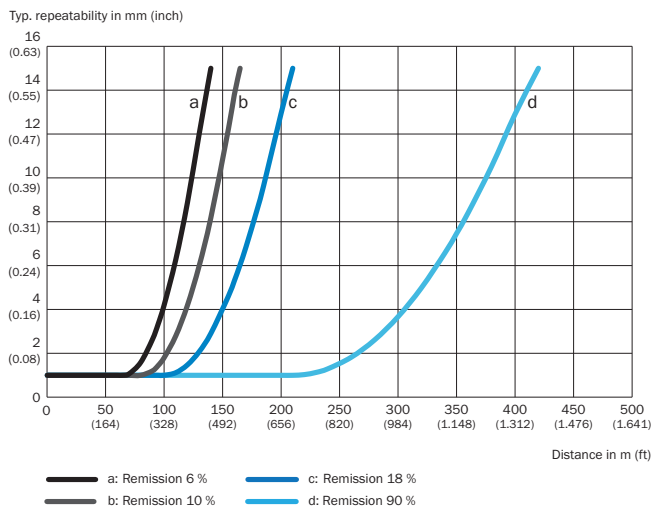

DT1000, with 128 ms measurement cycle time

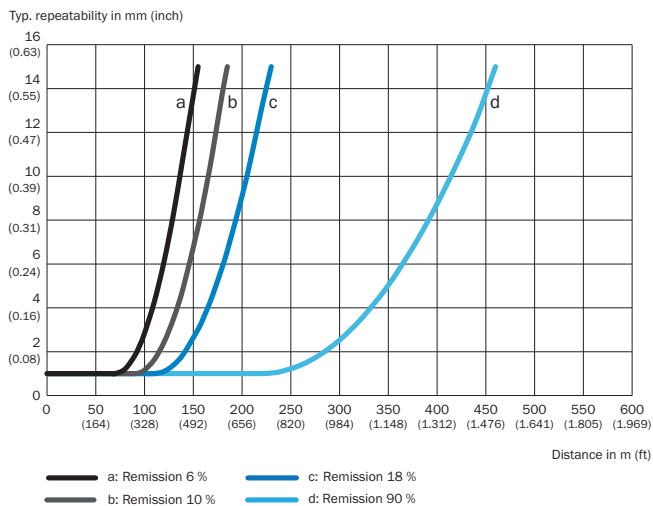

### DT1000, with 16 ms measurement cycle time

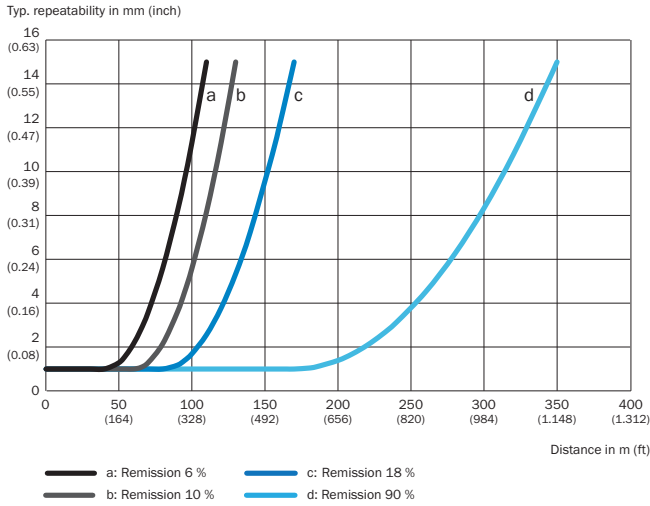

### DT1000, with 4 ms measurement cycle time

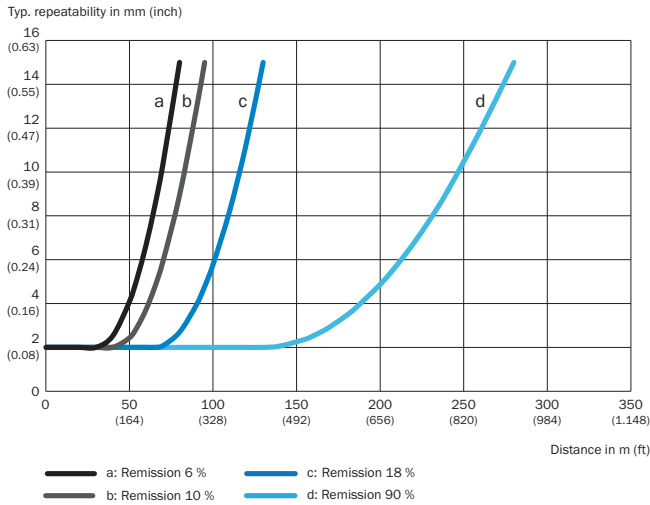

### DT1000, with 1 ms measurement cycle time

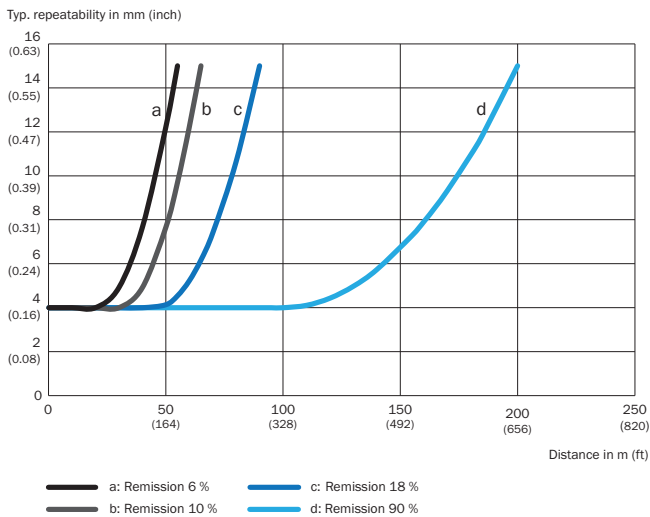



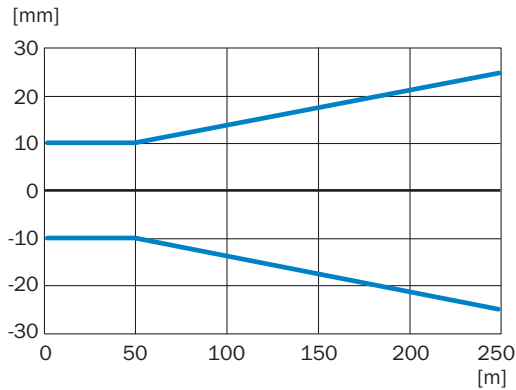

## Measurement accuracy

Typically DT1000, x-axis: Distance, y-axis: Typical measurement accuracy



## Recommended accessories

Other models and accessories → [www.sick.com/Dx1000](http://www.sick.com/Dx1000)

	Brief description	Type	Part no.
Device protection (mechanical)			
	Can be opened upward without tools. Conductor for connections on the back. Due to space constraints, connecting cables with 90° angled, pre-assembled male connectors/female connectors are required., Weatherproof housing (BEF-AH-DX1000, tube for weatherproof housing and rain cover for protective housing are not included with delivery)	Weather-proof housing	2087690
Terminal and alignment brackets			
	Alignment bracket for mounting and precise alignment of the sensor in a horizontal and vertical direction, stainless steel, mounting hardware included	BEF-AH-DX1000	2080392
Others			
	<ul style="list-style-type: none"> <li><b>Connection type head A:</b> Female connector, M12, 5-pin, angled, B-coded</li> <li><b>Connection type head B:</b> Flying leads</li> <li><b>Signal type:</b> PROFIBUS DP</li> <li><b>Cable:</b> 10 m, 2-wire, PUR, halogen-free</li> <li><b>Description:</b> PROFIBUS DP, twisted pair, shielded</li> <li><b>Application:</b> Zones with oils and lubricants</li> </ul>	DOL-1205-W10MQ	6041425
	<ul style="list-style-type: none"> <li><b>Connection type head A:</b> Male connector, M12, 5-pin, angled, B-coded</li> <li><b>Connection type head B:</b> Flying leads</li> <li><b>Signal type:</b> PROFIBUS DP</li> <li><b>Cable:</b> 10 m, 2-wire, PUR, halogen-free</li> <li><b>Description:</b> PROFIBUS DP, twisted pair, shielded</li> <li><b>Application:</b> Zones with oils and lubricants, Drag chain operation</li> </ul>	STL-1205-W10MQ	6041427
	<ul style="list-style-type: none"> <li><b>Connection type head A:</b> Female connector, M12, 8-pin, angled</li> <li><b>Connection type head B:</b> Flying leads</li> <li><b>Signal type:</b> RS-422, SSI</li> <li><b>Cable:</b> 10 m, 8-wire, PUR, halogen-free</li> <li><b>Description:</b> RS-422, SSI, shielded</li> </ul>	YG2A68-100XXXXLECX	6051482

## SICK AT A GLANCE

SICK is one of the leading manufacturers of intelligent sensors and sensor solutions for industrial applications. A unique range of products and services creates the perfect basis for controlling processes securely and efficiently, protecting individuals from accidents and preventing damage to the environment.

We have extensive experience in a wide range of industries and understand their processes and requirements. With intelligent sensors, we can deliver exactly what our customers need. In application centers in Europe, Asia and North America, system solutions are tested and optimized in accordance with customer specifications. All this makes us a reliable supplier and development partner.

Comprehensive services complete our offering: SICK LifeTime Services provide support throughout the machine life cycle and ensure safety and productivity.

For us, that is “Sensor Intelligence.”

## WORLDWIDE PRESENCE:

Contacts and other locations –[www.sick.com](http://www.sick.com)