



DT500-A123

Dx500

LONG RANGE DISTANCE SENSORS

SICK
Sensor Intelligence.



Ordering information

| Type | Part no. |
|------------|----------|
| DT500-A123 | 1040468 |

Other models and accessories → www.sick.com/Dx500



Detailed technical data

Features

| | | | | | |
|--|--|-------------------|-----------|-------------------|----|
| Measuring range | 0.2 m ... 30 m, 90% remission factor ^{1) 2)} 0.8 m ... 15 m, 6% remission factor ^{1) 2)} | | | | |
| Target | Natural objects | | | | |
| Resolution | ≤ 0.1 mm | | | | |
| Repeatability | 1 mm ^{3) 4)} | | | | |
| Measurement accuracy | ± 3 mm | | | | |
| Response time | 250 ms | | | | |
| Output time | 250 ms | | | | |
| Light source | Laser, red ⁵⁾ visible red light | | | | |
| Type of light | Visible red light | | | | |
| Laser class | 2, complies with 21 CFR 1040.10 and 1040.11 except for the conformance according to "Laser Notice No. 50" from June 24, 2007 (IEC 60825-1:2014, EN 60825-1:2014) | | | | |
| Typ. light spot size (distance) | 10 mm (at 7 m) 45 mm (at 30 m) 100 mm (at 70 m) | | | | |
| Safety-related parameters | <table border="0"> <tr> <td style="text-align: right;">MTTF_D</td> <td>101 years</td> </tr> <tr> <td style="text-align: right;">DC_{avg}</td> <td>0%</td> </tr> </table> | MTTF _D | 101 years | DC _{avg} | 0% |
| MTTF _D | 101 years | | | | |
| DC _{avg} | 0% | | | | |

¹⁾ In ambient light, max. 1 klx of constant light.

²⁾ Unique up to 150 m.

³⁾ 6% ... 90% remission factor.

⁴⁾ Statistical error 1 σ .

⁵⁾ Average service life of 50,000 h at T_A = +25 °C.

Interfaces

| | |
|-----------------------------------|----------------------|
| CAN | ✓ |
| Remark | Layer 2 |
| Multifunctional input (MF) | PNP ^{1) 2)} |
| Laser-off input | > 12 V |

¹⁾ Refer to function MF input.

²⁾ HIGH = UV - (< 2 V) / LOW = < 2 V; active HIGH.

Electronics

| | |
|--|---|
| Supply voltage U_B | DC 10 V ... 30 V, reverse polarity protected $U_V \geq$ DC 24 V for devices with heating |
| Power consumption | Typ. 3 W |
| Ripple | 5 V _{pp} ¹⁾ |
| Initialization time | 500 ms |
| Enclosure rating | IP65 |
| Protection class | II ²⁾ |

¹⁾ May not fall short of or exceed V_S tolerances.

²⁾ Reference voltage DC 32 V.

Mechanics

| | |
|-------------------------------|----------------------------|
| Dimensions (W x H x D) | 69 mm x 50 mm x 153 mm |
| Housing material | Metal (Aluminum die cast) |
| Window material | Glass |
| Weight | 1,000 g |
| Connection type | Male connector, M12, 8-pin |

Ambient data

| | |
|--|---|
| Ambient temperature, operation | -10 °C ... +45 °C -10 °C ... +75 °C, operation with cooling case |
| Ambient temperature, storage | -25 °C ... +75 °C |
| Temperature drift | Typ. 0.05 mm/K |
| Typ. Ambient light immunity | ≤ 3,000 lx |
| Mechanical load | Shock: (EN 600 68-2-27 / -2-29) Sine: (EN 600 68-2-6) Noise: (EN 600 68-2-64) |
| Electromagnetic compatibility (EMC) | EN 61000-6-2, EN 61000-6-3 |

Classifications

| | |
|---------------------|----------|
| ECLASS 5.0 | 27270801 |
| ECLASS 5.1.4 | 27270801 |
| ECLASS 6.0 | 27270801 |
| ECLASS 6.2 | 27270801 |
| ECLASS 7.0 | 27270801 |
| ECLASS 8.0 | 27270801 |
| ECLASS 8.1 | 27270801 |
| ECLASS 9.0 | 27270801 |
| ECLASS 10.0 | 27270801 |
| ECLASS 11.0 | 27270801 |
| ECLASS 12.0 | 27270916 |
| ETIM 5.0 | EC001825 |
| ETIM 6.0 | EC001825 |
| ETIM 7.0 | EC001825 |
| ETIM 8.0 | EC001825 |

UNSPSC 16.0901

41111613

Dimensional drawing (Dimensions in mm (inch))

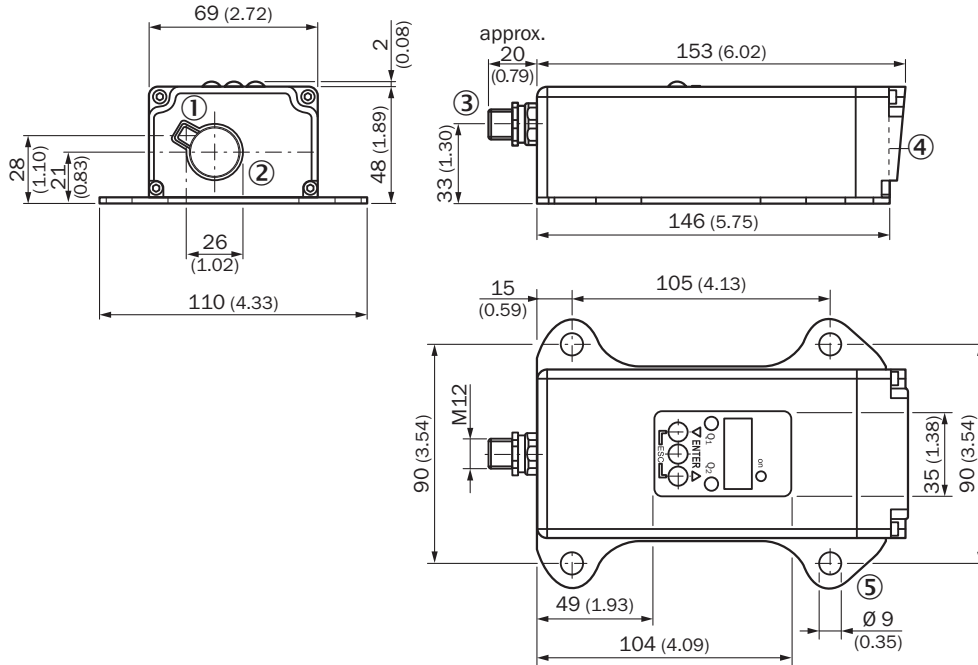

- ① Optical axis, sender
- ② Optical axis, receiver
- ③ Male connector M12, 5-pin
- ④ Zero level
- ⑤ Fixing hole

Connection type

DT500-Axx3 CAN (Layer 2) Connector M12, 8-pin

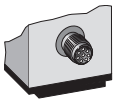

Connection diagram

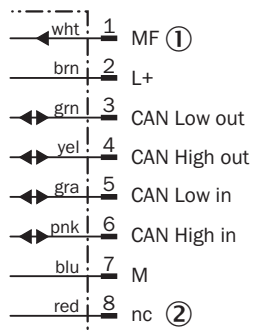

- ① Multifunctional input (MF)
- ② Not assigned

Adjustment possible

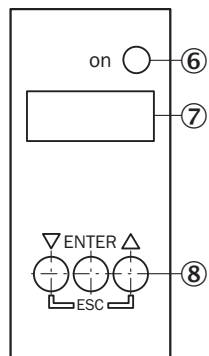

- ⑥ Operating indicator
- ⑦ Indicator panel, 7-segment display
- ⑧ Control panel

Functional principle

Additional information

Extern Teach ET via MF ①

| Teach-in | MF active | Model |
|-----------|-----------|-----------------------------------|
| 0 mA | 100 ms | Current measurement value is used |
| 4 mA | 200 ms | |
| 20 mA | 300 ms | |
| Laser off | > 450 ms | |

① Multi functional input.

Error performance or no object in measurement range

Measurement not possible

| Measurement value output display | Analog interface | CAN Bus | Serial interface |
|----------------------------------|------------------|---------|------------------|
| 0.000 | 0/3.5 mA | 00000 | 00000 CRLF |

No object in measurement range or laser off

| Measurement value output display | Analog interface | CAN Bus | Serial interface |
|----------------------------------|------------------|---------|------------------|
| 99.99 | 20.5 mA | 99999 | 99999 CRLF |



Function MF input

Function MF input

| | | |
|-----------|-------|----------------------|
| Teach in | 0 mA | 60 ms < MF < 150 ms |
| Teach in | 4 mA | 150 ms < MF < 250 ms |
| Teach in | 20 mA | 250 ms < MF < 350 ms |
| Laser off | - | 450 ms < MF < ∞ |

Recommended accessories

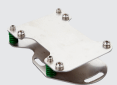
Other models and accessories → www.sick.com/Dx500

| | Brief description | Type | Part no. |
|---|---|--------------------|----------|
| Terminal and alignment brackets | | | |
|  | <ul style="list-style-type: none"> Description: Alignment unit for DS/DT500, stainless steel (1.4541), incl. mounting material Items supplied: Mounting hardware included | BEF-DSDT | 2031377 |
| Others | | | |
|  | <ul style="list-style-type: none"> Connection type head A: Female connector, M12, 8-pin, straight Connection type head B: Flying leads Cable: 5 m, 8-wire, PUR, halogen-free Description: Shielded | YF2A68-050XXXXLEAX | 6032449 |
|  | <ul style="list-style-type: none"> Connection type head A: Female connector, M12, 8-pin, straight, A-coded Description: Shielded Connection systems: Screw-type terminals Permitted cross-section: 0.25 mm² ... 0.5 mm² | DOS-1208-GA | 6028369 |

SICK AT A GLANCE

SICK is one of the leading manufacturers of intelligent sensors and sensor solutions for industrial applications. A unique range of products and services creates the perfect basis for controlling processes securely and efficiently, protecting individuals from accidents and preventing damage to the environment.

We have extensive experience in a wide range of industries and understand their processes and requirements. With intelligent sensors, we can deliver exactly what our customers need. In application centers in Europe, Asia and North America, system solutions are tested and optimized in accordance with customer specifications. All this makes us a reliable supplier and development partner.

Comprehensive services complete our offering: SICK LifeTime Services provide support throughout the machine life cycle and ensure safety and productivity.

For us, that is “Sensor Intelligence.”

WORLDWIDE PRESENCE:

Contacts and other locations –www.sick.com