



# DT500-A311

Dx500

LONG RANGE DISTANCE SENSORS

**SICK**  
Sensor Intelligence.



### Ordering information

Type	Part no.
DT500-A311	1040475

Other models and accessories → [www.sick.com/Dx500](http://www.sick.com/Dx500)



### Detailed technical data

#### Features

<b>Measuring range</b>	0.2 m ... 7 m, 90% remission factor <sup>1) 2)</sup> 0.8 m ... 7 m, 6% remission factor <sup>1) 2)</sup>				
<b>Target</b>	Natural objects				
<b>Resolution</b>	12 bit				
<b>Repeatability</b>	1 mm <sup>3) 4)</sup>				
<b>Measurement accuracy</b>	± 3 mm				
<b>Response time</b>	150 ms				
<b>Output time</b>	150 ms				
<b>Light source</b>	Laser, red <sup>5)</sup> visible red light				
<b>Type of light</b>	Visible red light				
<b>Laser class</b>	2, complies with 21 CFR 1040.10 and 1040.11 except for the conformance according to "Laser Notice No. 50" from June 24, 2007 (IEC 60825-1:2014, EN 60825-1:2014)				
<b>Typ. light spot size (distance)</b>	10 mm (at 7 m) 45 mm (at 30 m) 100 mm (at 70 m)				
<b>Safety-related parameters</b>	<table border="0"> <tr> <td style="text-align: right;">MTTF<sub>D</sub></td> <td>101 years</td> </tr> <tr> <td style="text-align: right;">DC<sub>avg</sub></td> <td>0%</td> </tr> </table>	MTTF <sub>D</sub>	101 years	DC <sub>avg</sub>	0%
MTTF <sub>D</sub>	101 years				
DC <sub>avg</sub>	0%				

<sup>1)</sup> In ambient light, max. 1 klx of constant light.

<sup>2)</sup> Unique up to 7 m.

<sup>3)</sup> 6% ... 90% remission factor.

<sup>4)</sup> Statistical error 1  $\sigma$ .

<sup>5)</sup> Average service life of 50,000 h at T<sub>A</sub> = +25 °C.

#### Interfaces

Analog output	
Number	1
Type	Current output

<sup>1)</sup> Can be configured to the device: 0 mA ... 20 mA / 4 mA ... 20 mA (max. load resistance = U<sub>V</sub>-2 V / 0.0205 A).

<sup>2)</sup> Refer to function MF input.

<sup>3)</sup> HIGH = UV - (< 2 V) / LOW = < 2 V; active HIGH.

	Current	0 mA ... 20 mA <sup>1)</sup>
<b>Multifunctional input (MF)</b>		PNP <sup>2) 3)</sup>
<b>Laser-off input</b>		> 12 V

<sup>1)</sup> Can be configured to the device: 0 mA ... 20 mA / 4 mA ... 20 mA (max. load resistance =  $U_V - 2 \text{ V} / 0.0205 \text{ A}$ ).

<sup>2)</sup> Refer to function MF input.

<sup>3)</sup> HIGH = UV - (< 2 V) / LOW = < 2 V; active HIGH.

## Electronics

<b>Supply voltage <math>U_B</math></b>	DC 10 V ... 30 V, reverse polarity protected $U_V \geq \text{DC } 24 \text{ V}$ for devices with heating
<b>Power consumption</b>	Typ. 3 W
<b>Ripple</b>	5 V <sub>pp</sub> <sup>1)</sup>
<b>Initialization time</b>	500 ms
<b>Enclosure rating</b>	IP65
<b>Protection class</b>	II <sup>2)</sup>

<sup>1)</sup> May not fall short of or exceed V<sub>S</sub> tolerances.

<sup>2)</sup> Reference voltage DC 32 V.

## Mechanics

<b>Dimensions (W x H x D)</b>	69 mm x 50 mm x 153 mm
<b>Housing material</b>	Metal (Aluminum die cast)
<b>Window material</b>	Glass
<b>Weight</b>	1,000 g
<b>Connection type</b>	Male connector, M12, 5-pin

## Ambient data

<b>Ambient temperature, operation</b>	-10 °C ... +45 °C -10 °C ... +75 °C, operation with cooling case
<b>Ambient temperature, storage</b>	-25 °C ... +75 °C
<b>Temperature drift</b>	Typ. 0.05 mm/K
<b>Typ. Ambient light immunity</b>	≤ 3,000 lx
<b>Mechanical load</b>	Shock: (EN 600 68-2-27 / -2-29) Sine: (EN 600 68-2-6) Noise: (EN 600 68-2-64)
<b>Electromagnetic compatibility (EMC)</b>	EN 61000-6-2, EN 61000-6-3

## Classifications

<b>ECLASS 5.0</b>	27270801
<b>ECLASS 5.1.4</b>	27270801
<b>ECLASS 6.0</b>	27270801
<b>ECLASS 6.2</b>	27270801
<b>ECLASS 7.0</b>	27270801
<b>ECLASS 8.0</b>	27270801
<b>ECLASS 8.1</b>	27270801
<b>ECLASS 9.0</b>	27270801
<b>ECLASS 10.0</b>	27270801

<b>ECLASS 11.0</b>	27270801
<b>ECLASS 12.0</b>	27270916
<b>ETIM 5.0</b>	EC001825
<b>ETIM 6.0</b>	EC001825
<b>ETIM 7.0</b>	EC001825
<b>ETIM 8.0</b>	EC001825
<b>UNSPSC 16.0901</b>	41111613

### Dimensional drawing (Dimensions in mm (inch))

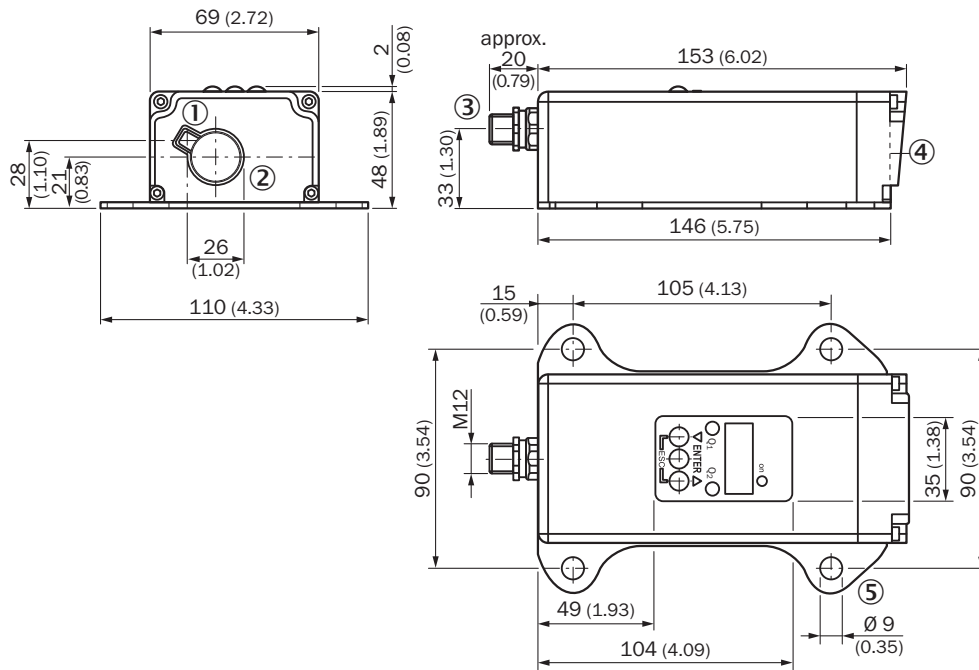

- ① Optical axis, sender
- ② Optical axis, receiver
- ③ Male connector M12, 5-pin
- ④ Zero level
- ⑤ Fixing hole

### Connection type

Male connector M12, 5-pin

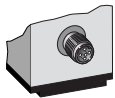

## Connection diagram

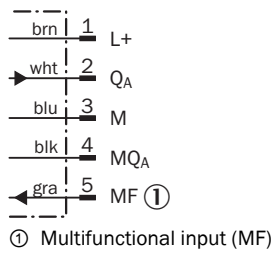

## Adjustment possible

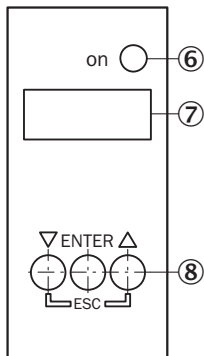

- ⑥ Operating indicator
- ⑦ Indicator panel, 7-segment display
- ⑧ Control panel

## Functional principle

Additional information

### Extern Teach ET via MF ①

Teach-in	MF active	Model
0 mA	100 ms	Current measurement value is used
4 mA	200 ms	
20 mA	300 ms	
Laser off	> 450 ms	

① Multi functional input.

### Error performance or no object in measurement range

#### Measurement not possible

Measurement value output display	Analog interface	CAN Bus	Serial interface
0.000	0/3.5 mA	00000	00000 CRLF

#### No object in measurement range or laser off

Measurement value output display	Analog interface	CAN Bus	Serial interface
99.99	20.5 mA	99999	99999 CRLF





Function MF input

### Function MF input

Teach in	0 mA	60 ms < MF < 150 ms
Teach in	4 mA	150 ms < MF < 250 ms
Teach in	20 mA	250 ms < MF < 350 ms
Laser off	-	450 ms < MF < ∞

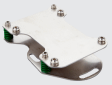
### Recommended accessories

Other models and accessories → [www.sick.com/Dx500](http://www.sick.com/Dx500)

	Brief description	Type	Part no.
Terminal and alignment brackets			
	<ul style="list-style-type: none"> <li><b>Description:</b> Alignment unit for DS/DT500, stainless steel (1.4541), incl. mounting material</li> <li><b>Items supplied:</b> Mounting hardware included</li> </ul>	BEF-DSDT	2031377
Others			
	<ul style="list-style-type: none"> <li><b>Connection type head A:</b> Female connector, M12, 5-pin, straight, A-coded</li> <li><b>Connection type head B:</b> Flying leads</li> <li><b>Signal type:</b> Sensor/actuator cable</li> <li><b>Cable:</b> 2 m, 5-wire, PVC</li> <li><b>Description:</b> Sensor/actuator cable, unshielded</li> <li><b>Application:</b> Zones with chemicals, Uncontaminated zones</li> </ul>	YF2A15-020VB5XLEAX	2096239
	<ul style="list-style-type: none"> <li><b>Connection type head A:</b> Female connector, M12, 5-pin, straight, A-coded</li> <li><b>Connection type head B:</b> Flying leads</li> <li><b>Signal type:</b> Sensor/actuator cable</li> <li><b>Cable:</b> 5 m, 5-wire, PVC</li> <li><b>Description:</b> Sensor/actuator cable, unshielded</li> <li><b>Application:</b> Zones with chemicals, Uncontaminated zones</li> </ul>	YF2A15-050VB5XLEAX	2096240
	<ul style="list-style-type: none"> <li><b>Connection type head A:</b> Female connector, M12, 5-pin, straight, A-coded</li> <li><b>Connection type head B:</b> Flying leads</li> <li><b>Signal type:</b> Sensor/actuator cable</li> <li><b>Cable:</b> 10 m, 5-wire, PVC</li> <li><b>Description:</b> Sensor/actuator cable, unshielded</li> <li><b>Application:</b> Zones with chemicals, Uncontaminated zones</li> </ul>	YF2A15-100VB5XLEAX	2096241

## SICK AT A GLANCE

SICK is one of the leading manufacturers of intelligent sensors and sensor solutions for industrial applications. A unique range of products and services creates the perfect basis for controlling processes securely and efficiently, protecting individuals from accidents and preventing damage to the environment.

We have extensive experience in a wide range of industries and understand their processes and requirements. With intelligent sensors, we can deliver exactly what our customers need. In application centers in Europe, Asia and North America, system solutions are tested and optimized in accordance with customer specifications. All this makes us a reliable supplier and development partner.

Comprehensive services complete our offering: SICK LifeTime Services provide support throughout the machine life cycle and ensure safety and productivity.

For us, that is “Sensor Intelligence.”

## WORLDWIDE PRESENCE:

Contacts and other locations –[www.sick.com](http://www.sick.com)