



DT500-A511S03

Dx500

LONG RANGE DISTANCE SENSORS

SICK
Sensor Intelligence.



Ordering information

Type	Part no.
DT500-A511S03	1055352

Other models and accessories → www.sick.com/Dx500



Detailed technical data

Features

Measuring range	0.2 m ... 70 m, 90% remission factor ^{1) 2)} 0.2 m ... 30 m, 6% remission factor ^{1) 2)}
Target	Natural objects
Resolution	12 bit
Repeatability	1 mm ^{3) 4)}
Measurement accuracy	± 3 mm
Response time	150 ms ... 6,000 ms
Output time	150 ms ... 6,000 ms
Light source	Laser, red ⁵⁾ visible red light
Type of light	Visible red light
Laser class	2, complies with 21 CFR 1040.10 and 1040.11 except for the conformance according to "Laser Notice No. 50" from June 24, 2007 (IEC 60825-1:2014, EN 60825-1:2014)
Typ. light spot size (distance)	10 mm (at 7 m) 45 mm (at 30 m) 100 mm (at 70 m)
Filter	NIR filter for improving measuring properties on hot surfaces
Safety-related parameters	
	MTTF _D 101 years
	DC _{avg} 0%

¹⁾ In ambient light, max. 1 klx of constant light.

²⁾ Unique up to 150 m.

³⁾ 6% ... 90% remission factor.

⁴⁾ Statistical error 1 σ .

⁵⁾ Average service life of 50,000 h at T_A = +25 °C.

Interfaces

Analog output	
	Number 1

¹⁾ Can be configured to the device: 0 mA ... 20 mA / 4 mA ... 20 mA (max. load resistance = U_{V-2} V / 0.0205 A).

²⁾ Refer to function MF input.

³⁾ HIGH = UV - (< 2 V) / LOW = < 2 V; active HIGH.

	Type	Current output
	Current	0 mA ... 20 mA ¹⁾
Multifunctional input (MF)		PNP ^{2) 3)}
Laser-off input		> 12 V

¹⁾ Can be configured to the device: 0 mA ... 20 mA / 4 mA ... 20 mA (max. load resistance = $U_V - 2 \text{ V} / 0.0205 \text{ A}$).

²⁾ Refer to function MF input.

³⁾ HIGH = UV - (< 2 V) / LOW = < 2 V; active HIGH.

Electronics

Supply voltage U_B	DC 10 V ... 30 V, reverse polarity protected $U_V \geq \text{DC } 24 \text{ V}$ for devices with heating
Power consumption	Typ. 3 W
Ripple	5 V _{pp} ¹⁾
Initialization time	500 ms
Enclosure rating	IP65
Protection class	II ²⁾

¹⁾ May not fall short of or exceed V_S tolerances.

²⁾ Reference voltage DC 32 V.

Mechanics

Dimensions (W x H x D)	69 mm x 50 mm x 153 mm
Housing material	Metal (Aluminum die cast)
Window material	Glass
Weight	1,000 g
Connection type	Male connector, M12, 5-pin

Ambient data

Ambient temperature, operation	-10 °C ... +45 °C -10 °C ... +75 °C, operation with cooling case
Ambient temperature, storage	-25 °C ... +75 °C
Temperature drift	Typ. 0.05 mm/K
Typ. Ambient light immunity	$\leq 3,000 \text{ lx}$
Mechanical load	Shock: (EN 600 68-2-27 / -2-29) Sine: (EN 600 68-2-6) Noise: (EN 600 68-2-64)
Electromagnetic compatibility (EMC)	EN 61000-6-2, EN 61000-6-3

Classifications

ECLASS 5.0	27270801
ECLASS 5.1.4	27270801
ECLASS 6.0	27270801
ECLASS 6.2	27270801
ECLASS 7.0	27270801
ECLASS 8.0	27270801
ECLASS 8.1	27270801
ECLASS 9.0	27270801

DT500-A511S03 | Dx500

LONG RANGE DISTANCE SENSORS

ECLASS 10.0	27270801
ECLASS 11.0	27270801
ECLASS 12.0	27270916
ETIM 5.0	EC001825
ETIM 6.0	EC001825
ETIM 7.0	EC001825
ETIM 8.0	EC001825
UNSPSC 16.0901	41111613

Dimensional drawing (Dimensions in mm (inch))

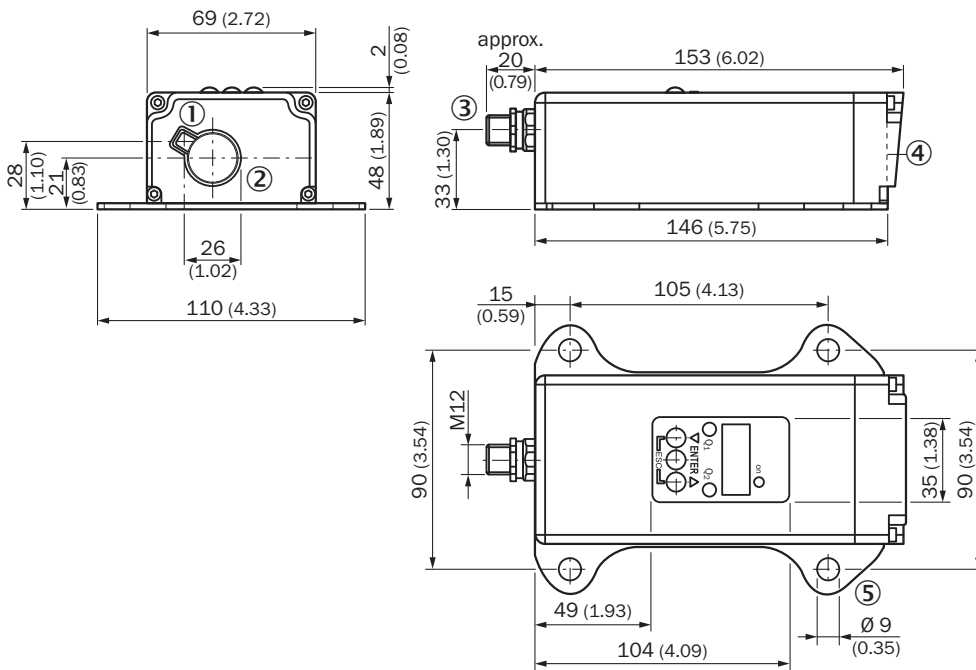

- ① Optical axis, sender
- ② Optical axis, receiver
- ③ Male connector M12, 5-pin
- ④ Zero level
- ⑤ Fixing hole

Connection type

Male connector M12, 5-pin

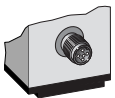

Adjustment possible

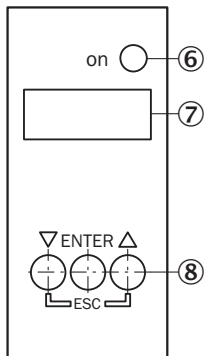

- ⑥ Operating indicator
- ⑦ Indicator panel, 7-segment display
- ⑧ Control panel

Functional principle

Additional information

Extern Teach ET via MF ①

Teach-in	MF active	Model
0 mA	100 ms	Current measurement value is used
4 mA	200 ms	
20 mA	300 ms	
Laser off	> 450 ms	

① Multi functional input.

Error performance or no object in measurement range

Measurement not possible

Measurement value output display	Analog interface	CAN Bus	Serial interface
0.000	0/3.5 mA	00000	00000 CRLF

No object in measurement range or laser off

Measurement value output display	Analog interface	CAN Bus	Serial interface
99.99	20.5 mA	99999	99999 CRLF





Function MF input

Function MF input

Teach in	0 mA	60 ms < MF < 150 ms
Teach in	4 mA	150 ms < MF < 250 ms
Teach in	20 mA	250 ms < MF < 350 ms
Laser off	-	450 ms < MF < ∞

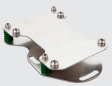
Recommended accessories

Other models and accessories → www.sick.com/Dx500

	Brief description	Type	Part no.
Terminal and alignment brackets			
	<ul style="list-style-type: none"> • Description: Alignment unit for DS/DT500, stainless steel (1.4541), incl. mounting material • Items supplied: Mounting hardware included 	BEF-DSDT	2031377
Others			
	<ul style="list-style-type: none"> • Connection type head A: Female connector, M12, 5-pin, straight, A-coded • Connection type head B: Flying leads • Signal type: Sensor/actuator cable • Cable: 2 m, 5-wire, PVC • Description: Sensor/actuator cable, unshielded • Application: Zones with chemicals, Uncontaminated zones 	YF2A15-020VB5XLEAX	2096239
	<ul style="list-style-type: none"> • Connection type head A: Female connector, M12, 5-pin, straight, A-coded • Connection type head B: Flying leads • Signal type: Sensor/actuator cable • Cable: 5 m, 5-wire, PVC • Description: Sensor/actuator cable, unshielded • Application: Zones with chemicals, Uncontaminated zones 	YF2A15-050VB5XLEAX	2096240
	<ul style="list-style-type: none"> • Connection type head A: Female connector, M12, 5-pin, straight, A-coded • Connection type head B: Flying leads • Signal type: Sensor/actuator cable • Cable: 10 m, 5-wire, PVC • Description: Sensor/actuator cable, unshielded • Application: Zones with chemicals, Uncontaminated zones 	YF2A15-100VB5XLEAX	2096241

SICK AT A GLANCE

SICK is one of the leading manufacturers of intelligent sensors and sensor solutions for industrial applications. A unique range of products and services creates the perfect basis for controlling processes securely and efficiently, protecting individuals from accidents and preventing damage to the environment.

We have extensive experience in a wide range of industries and understand their processes and requirements. With intelligent sensors, we can deliver exactly what our customers need. In application centers in Europe, Asia and North America, system solutions are tested and optimized in accordance with customer specifications. All this makes us a reliable supplier and development partner.

Comprehensive services complete our offering: SICK LifeTime Services provide support throughout the machine life cycle and ensure safety and productivity.

For us, that is “Sensor Intelligence.”

WORLDWIDE PRESENCE:

Contacts and other locations –www.sick.com