



DT50-N1124

Dx50

MID RANGE DISTANCE SENSORS

SICK
Sensor Intelligence.



Ordering information

Type	Part no.
DT50-N1124	1047617

Other models and accessories → www.sick.com/Dx50



Detailed technical data

Features

Measuring range	200 mm ... 10,000 mm, 90% remission factor 200 mm ... 5,000 mm, 18 % remission 200 mm ... 2,500 mm, 6% remission factor
Target	Natural objects
Resolution	1 mm
Repeatability	≥ 2.5 mm ^{1) 2) 3)}
Measurement accuracy	± 10 mm ⁴⁾
Response time	20 ms ... 30 ms, 20 ms / 30 ms ^{3) 5)}
Output time	≥ 4 ms ⁶⁾
Light source	Laser, red visible red light
Type of light	Visible red light
Laser class	1 (IEC 60825-1:2014, EN 60825-1:2014) ⁷⁾
Typ. light spot size (distance)	15 mm x 15 mm (10 m)
Additional function	Set moving average: fast/slow Switching mode: distance to object (Dt0) Teach-in, scaling and inversion of digital output Set hysteresis Teach-in, scaling and inversion of analog output Multifunctional input: laser off / external teach / deactivated Switch-off display Reset to factory default Lock user interface
Average laser service life (at 25 °C)	100,000 h

¹⁾ Equivalent to 1 σ .

²⁾ 6% ... 90% remission factor.

³⁾ Dependent on the averaging setting: fast/slow.

⁴⁾ 90% remission factor.

⁵⁾ Lateral entry of the object into the measuring range.

⁶⁾ Continuous change of distance in measuring range.

⁷⁾ Wavelength: 658 nm; max. output: 120 mW; pulse duration: 2.5 ns; duty cycle: 1/400.

Safety-related parameters	
MTTF _D	101 years
DC _{avg}	0%

- 1) Equivalent to 1 σ .
- 2) 6% ... 90% remission factor.
- 3) Dependent on the averaging setting: fast/slow.
- 4) 90% remission factor.
- 5) Lateral entry of the object into the measuring range.
- 6) Continuous change of distance in measuring range.
- 7) Wavelength: 658 nm; max. output: 120 mW; pulse duration: 2.5 ns; duty cycle: 1/400.

Interfaces

Digital output	
Number	1 ^{1) 2)}
Type	NPN
Maximum output current I _A	≤ 100 mA
Analog output	
Number	1
Type	Voltage output
Voltage	0 V ... 10 V, ≥ 5,000 Ω
Resolution	16 bit
Multifunctional input (MF)	1 x ^{3) 4)}
Hysteresis	10 mm ... 1,000 mm

- 1) Output Q short-circuit protected.
- 2) NPN: HIGH = < 2.5 V / LOW = V_S.
- 3) Response time ≤ 15ms.
- 4) NPN: HIGH = ≤ 2.5 V / LOW = V_S.

Electronics

Supply voltage U_B	DC 15 V ... 30 V ^{1) 2)}
Power consumption	≤ 2.1 W ³⁾
Ripple	≤ 5 V _{pp} ⁴⁾
Initialization time	≤ 250 ms
Warm-up time	≤ 15 min
Indication	LC display, 2 x LED
Enclosure rating	IP65
Protection class	III

- 1) Limit values, reverse-polarity protected, operation in short-circuit protected network: max. 8 A.
- 2) For DT50-xxx4: V_S > 15 V.
- 3) Without load.
- 4) May not fall short of or exceed V_S tolerances.

Mechanics

Dimensions (W x H x D)	36.1 mm x 62.7 mm x 57.7 mm
Housing material	Metal (zinc diecast)
Window material	Plastic (PMMA)

Weight	200 g
Connection type	Male connector, M12, 5-pin

Ambient data

Ambient temperature, operation	-30 °C ... +65 °C -30 °C ... +80 °C, operation with 2 cooling plates -30 °C ... +140 °C, operation with 2 cooling plates and protection filter
Ambient temperature, storage	-40 °C ... +75 °C
Max. rel. humidity (not condensing)	≤ 95 %
Typ. Ambient light immunity	40,000 lx
Vibration resistance	EN 60068-2-6, EN 60068-2-64
Shock resistance	EN 60068-2-27

Classifications

ECLASS 5.0	27270801
ECLASS 5.1.4	27270801
ECLASS 6.0	27270801
ECLASS 6.2	27270801
ECLASS 7.0	27270801
ECLASS 8.0	27270801
ECLASS 8.1	27270801
ECLASS 9.0	27270801
ECLASS 10.0	27270801
ECLASS 11.0	27270801
ECLASS 12.0	27270916
ETIM 5.0	EC001825
ETIM 6.0	EC001825
ETIM 7.0	EC001825
ETIM 8.0	EC001825
UNSPSC 16.0901	41111613

Dimensional drawing (Dimensions in mm (inch))

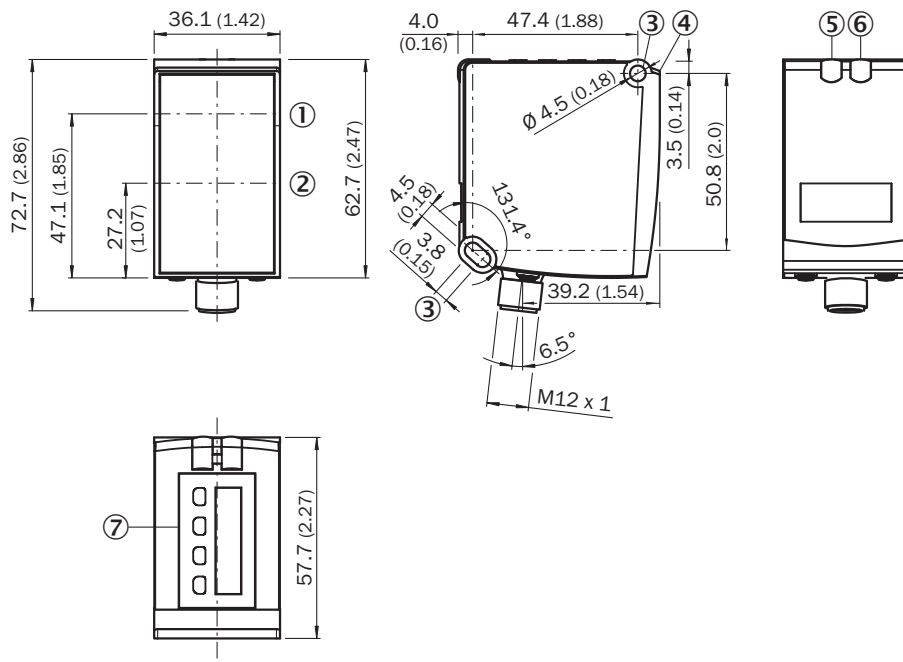

- ① Optical axis, sender
- ② Optical axis, receiver
- ③ Fixing hole
- ④ Reference surface = 0 mm
- ⑤ Status indicator digital output Q₁ (orange)
- ⑥ DT50/DT50 Hi/DL50: Status display for supply voltage active (green), DS50/DL50 Hi: Status display of digital output Q₂ (orange)
- ⑦ Control elements and display

Connection type

Male connector M12, 5-pin

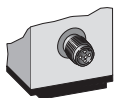



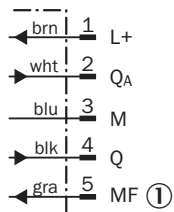

Connection diagram



- ① Multifunctional input (MF)

Recommended accessories

Other models and accessories → www.sick.com/Dx50

	Brief description	Type	Part no.
Others			
	<ul style="list-style-type: none"> • Connection type head A: Female connector, M12, 5-pin, angled, A-coded • Connection type head B: Flying leads • Signal type: HIPERFACE® • Cable: 5 m, 5-wire, PUR, halogen-free • Description: HIPERFACE®, shielded • Note: Sensor/actuator cable • Application: Zones with oils and lubricants, Drag chain operation 	DOL-1205-W05MAC	6041751
	<ul style="list-style-type: none"> • Connection type head A: Female connector, M12, 5-pin, angled, A-coded • Connection type head B: Flying leads • Signal type: Sensor/actuator cable • Cable: 2 m, 5-wire, PVC • Description: Sensor/actuator cable, unshielded • Application: Zones with chemicals, Uncontaminated zones 	YG2A15-020VB5XLEAX	2096215
	<ul style="list-style-type: none"> • Connection type head A: Female connector, M12, 5-pin, straight, A-coded • Connection type head B: Flying leads • Signal type: Sensor/actuator cable • Cable: 2 m, 5-wire, PUR, halogen-free • Description: Sensor/actuator cable, unshielded • Application: Uncontaminated zones, Zones with oils and lubricants, Robot, Drag chain operation 	YF2A15-020UB5XLEAX	2095617
	<ul style="list-style-type: none"> • Connection type head A: Female connector, M12, 5-pin, angled, A-coded • Connection type head B: Flying leads • Signal type: Sensor/actuator cable • Cable: 2 m, 5-wire, PUR, halogen-free • Description: Sensor/actuator cable, unshielded • Application: Uncontaminated zones, Zones with oils and lubricants, Robot, Drag chain operation 	YG2A15-020UB5XLEAX	2095772
	<ul style="list-style-type: none"> • Connection type head A: Female connector, M12, 5-pin, straight, A-coded • Connection type head B: Flying leads • Signal type: Sensor/actuator cable • Cable: 2 m, 5-wire, PVC • Description: Sensor/actuator cable, unshielded • Application: Zones with chemicals, Uncontaminated zones 	YF2A15-020VB5XLEAX	2096239

SICK AT A GLANCE

SICK is one of the leading manufacturers of intelligent sensors and sensor solutions for industrial applications. A unique range of products and services creates the perfect basis for controlling processes securely and efficiently, protecting individuals from accidents and preventing damage to the environment.

We have extensive experience in a wide range of industries and understand their processes and requirements. With intelligent sensors, we can deliver exactly what our customers need. In application centers in Europe, Asia and North America, system solutions are tested and optimized in accordance with customer specifications. All this makes us a reliable supplier and development partner.

Comprehensive services complete our offering: SICK LifeTime Services provide support throughout the machine life cycle and ensure safety and productivity.

For us, that is “Sensor Intelligence.”

WORLDWIDE PRESENCE:

Contacts and other locations –www.sick.com