



FFUC10-1C1SR

FFU

FLOW SENSORS

SICK
Sensor Intelligence.



Illustration may differ



Ordering information

Type	Part no.
FFUC10-1C1SR	6053120

Other models and accessories → www.sick.com/FFU

Detailed technical data

Features

Measurement principle	Ultrasonic sensor
Medium	Fluids
Nominal width measuring tube	DN 10
Process temperature	0 °C ... +80 °C
Process pressure	≤ 16 bar

Performance

Minimum flow	≥ 0.3 l/min ¹⁾
Maximum flow	≤ 21 l/min
Inlet zone	10 cm
Output zone	0 cm
Conductivity	No limitation
Measurement accuracy	± 1 % of measured value +/- 0.15% of measuring range limit value (with calibration log) ²⁾
Repeatability	≤ 0.5 %
Resolution	0.003 l/min
Calibration certificate	✓

¹⁾ At constant flow rate.

²⁾ Reference condition: Water, zero gas, measuring tube completely full, no cavitation, temperature of medium 20 °C, ambient temperature 20 °C ... 25 °C, compliance with inlet and outlet zones, warm-up time for electronics: 30 min.

Electronics

Supply voltage	18 V DC ... 30 V DC ¹⁾
Residual ripple	≤ 5 V _{pp} ²⁾
Power consumption	≤ 180 mA ³⁾
Initialization time	≤ 5 s

¹⁾ All connections are polarity protected. All outputs are overload and short-circuit protected.

²⁾ May not fall below or exceed U_y tolerances.

³⁾ Without load.

⁴⁾ There are 100 mA for each output PNP and NPN available.

⁵⁾ Analog output and display.

Protection class	III
Connection type	M12 round connector x 1, 8-pin
Output signal	Analog output 4 mA ... 20 mA, 0 mA ... 20 mA current flow and temperature 2 pulse/status output PNP/NPN-transistor output for flow rate meter, empty pipe detection, flow monitoring 1 switching input for dosing and counter reset ¹⁾
Output current	< 100 mA ⁴⁾
Output load	< 500 Ohm
Lower signal level	3.8 mA ... 4 mA
Upper signal level	20 mA ... 20.5 mA
Impuls/frequency output	0 kHz ... 10 kHz
Puls width	≤ 1 s
Inductive load	1 H
Capacitive load	100 nF
Response time	Filter off 100 ms, filter low 300 ms, filter medium 1 s, filter strong 4.2 s ⁵⁾

¹⁾ All connections are polarity protected. All outputs are overload and short-circuit protected.

²⁾ May not fall below or exceed U_V tolerances.

³⁾ Without load.

⁴⁾ There are 100 mA for each output PNP and NPN available.

⁵⁾ Analog output and display.

Mechanics

Process connection	Clamp (DIN 11864-3)
Wetted parts	PPSU EPDM
Housing material	PPSU
Enclosure rating	IP67
Weight	340 g

Ambient data

Ambient operating temperature	0 °C ... +60 °C
Ambient temperature, storage	-20 °C ... +70 °C

Classifications

ECLASS 5.0	27200412
ECLASS 5.1.4	27200412
ECLASS 6.0	27200412
ECLASS 6.2	27200412
ECLASS 7.0	27200412
ECLASS 8.0	27200412
ECLASS 8.1	27200412
ECLASS 9.0	27200412
ECLASS 10.0	27200412
ECLASS 11.0	27200412
ECLASS 12.0	27200412
ETIM 5.0	EC002580

ETIM 6.0	EC002580
ETIM 7.0	EC002580
ETIM 8.0	EC002580
UNSPSC 16.0901	41112501

Dimensional drawing (Dimensions in mm (inch))

DN 10, Clamp (DIN 11864-3)

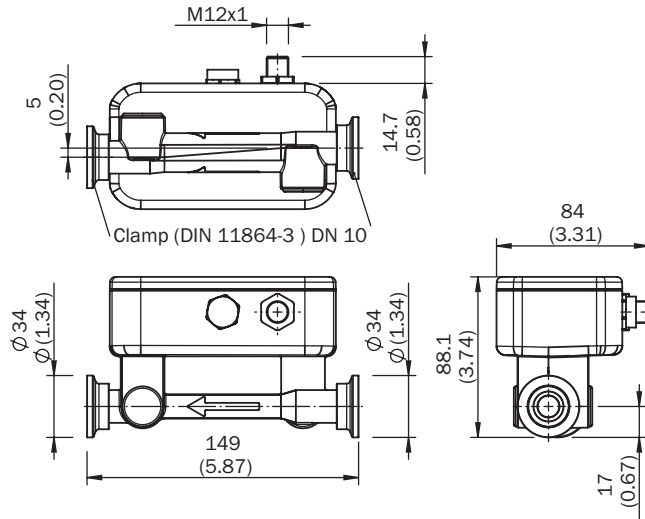

Connection type

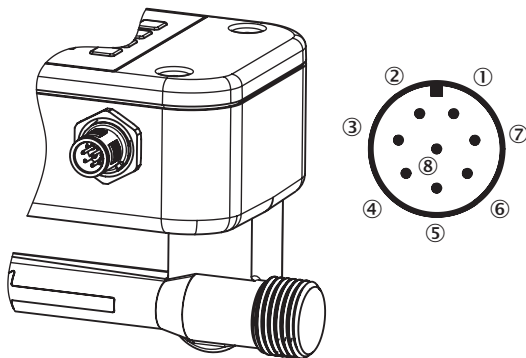

- ① L⁺: Supply voltage
- ② Q₁: Digital output PNP/NPN
- ③ M: Ground
- ④ Q₂: Digital output PNP/NPN
- ⑤ Q_A: Analog current output
- ⑥ C: Communication
- ⑦ IN₁: Digital input
- ⑧ No function

SICK AT A GLANCE

SICK is one of the leading manufacturers of intelligent sensors and sensor solutions for industrial applications. A unique range of products and services creates the perfect basis for controlling processes securely and efficiently, protecting individuals from accidents and preventing damage to the environment.

We have extensive experience in a wide range of industries and understand their processes and requirements. With intelligent sensors, we can deliver exactly what our customers need. In application centers in Europe, Asia and North America, system solutions are tested and optimized in accordance with customer specifications. All this makes us a reliable supplier and development partner.

Comprehensive services complete our offering: SICK LifeTime Services provide support throughout the machine life cycle and ensure safety and productivity.

For us, that is “Sensor Intelligence.”

WORLDWIDE PRESENCE:

Contacts and other locations –www.sick.com