



FTS-H060F04B

T-Easic FTS

FLOW SENSORS

SICK
Sensor Intelligence.



Illustration may differ



Ordering information

Type	Part no.
FTS-H060F04B	1114235

Other models and accessories → www.sick.com/T-Easic_FTS

Detailed technical data

Features

Measurement principle	Calorimetric measurement process
Medium	Water and oil-based liquids
Pipe diameters	≥ 25 mm ¹⁾
Measuring range	3 cm/s ... 300 cm/s, Water 3 cm/s ... 300 cm/s, Oil A / Oil B 3 cm/s ... 600 cm/s, Taught-in media ²⁾
Process temperature	-40 °C ... +150 °C ³⁾
Process pressure	-1 bar ... 100 bar, 40 bar (with SICK T-connector DN15, DN25), 25 bar (with SICK T-connector DN40), 20 bar (with SICK T-connector DN50) ⁴⁾
Communication interface	IO-Link, IO-Link V1.1, COM3 (230.4 kbit/s)
Temperature measurement	✓

¹⁾ Place probe tip in the center of the pipe to ensure the highest measurement accuracy.

²⁾ The measuring range limit value depends on the medium used.

³⁾ At medium temperatures above 100 °C, the distance between the bottom of the housing and the top of the process connection adapter must be at least 25 mm. If a SICK process connection adapter is used, the 60 mm probe cannot be used at process temperatures above 100 °C because the distances cannot be maintained.

⁴⁾ According to the Pressure Equipment Directive 2014/68 / EU: Good engineering practice, according to Article 13 for media of media group 2 (other substances).

Performance

Inlet zone	5 x DN
-------------------	--------

¹⁾ Under reference conditions with water, diameter of inner pipe 25 mm, vertical installation in pipe, probe tip in tube center, fully-filled pipe without air bubbles, speed from 10 cm/s to 100 cm/s, inlet zone > 30 cm, outlet zone > 30 cm, 26 °C ± 1 °C, 2 bar ± 1 bar.

²⁾ Filter off.

³⁾ Under reference conditions with water, pipe diameter 25 mm, vertical installation in pipe, tip in pipe center, fully-filled pipe without air bubbles, speed = 100 cm/s, inlet zone > 30 cm, outlet zone < 30 cm, 26 °C ± 1 °C, 2 bar ± 1 bar.

Output zone	3 x DN
Measurement accuracy	$\pm 7\%$ From measured value + 2% of measuring range end value ¹⁾
Repeatability	< 1 cm/s ¹⁾
Resolution	0.01 m/s Speed; 0.1 L/min volume; 0.1% relative (via IO-Link)
Temperature drift	< 0.5 cm / (s*K) ¹⁾
Response time	< 2.5 s ²⁾
Temperature measurement	
Measurement accuracy (temperature)	$\pm 1\text{ }^{\circ}\text{C}$
Resolution (Temperature)	< 0.1 $^{\circ}\text{C}$
Response time (temperature)	< 5 s ³⁾
Operating mode	Relative speed (%), Volume flow and total volume, Relative teach (%)

¹⁾ Under reference conditions with water, diameter of inner pipe 25 mm, vertical installation in pipe, probe tip in tube center, fully-filled pipe without air bubbles, speed from 10 cm/s to 100 cm/s, inlet zone > 30 cm, outlet zone > 30 cm, 26 $^{\circ}\text{C} \pm 1\text{ }^{\circ}\text{C}$, 2 bar ± 1 bar.

²⁾ Filter off.

³⁾ Under reference conditions with water, pipe diameter 25 mm, vertical installation in pipe, tip in pipe center, fully-filled pipe without air bubbles, speed = 100 cm/s, inlet zone > 30 cm, outlet zone < 30 cm, 26 $^{\circ}\text{C} \pm 1\text{ }^{\circ}\text{C}$, 2 bar ± 1 bar.

Electronics

Supply voltage	9 V DC ... 30 V DC ¹⁾
Power consumption	< 2 W at 24 V DC (without load on the outputs) < 8 W At maximum load
Initialization time	≤ 5 s ≤ 10 s (IO-Link)
Protection class	III
Connection type	M12 round connector x 1, 4-pin
Output signal	2 push-pull digital outputs (Q1 configurable for IO-Link; Q2 configurable as analog output (4 ... 20 mA) / pulse output / digital input) for flow and temperature
Output current	< 100 mA ²⁾
Output load	4 mA ... 20 mA, max. 350 Ohm, if $U_v < 12$ V, 500 Ohm if $U_v > 12$ V
Lower signal level	3.5 mA ... 3.8 mA
Upper signal level	20.5 mA ... 21.5 mA
Inaccuracy	QA Pin2: < 0.5% full-range (20 mA)
Inductive load	1 H
Capacitive load	100 nF (2.5 nF, IO-Link mode)
EMC	EN 61326-1, EN 61326-2-3
Digital input limit	HIGH voltage dependent on U_v LOW voltage < 4.0 V
MTTF	> 200 years

¹⁾ All connections are reverse polarity and overload protected. Q1 and Q2 are short-circuit protected. Use an energy-limited circuit for the voltage supply as per UL61010-1 3. Outp.

²⁾ Per output.

Mechanics

Process connection	Without process connection (adapter needed for installation)
---------------------------	--

¹⁾ Only with M12 male connector attached / not UL-tested.

Wetted parts	Stainless steel 1.4404 (Ra ≤ 0,8 µm)
Housing material	Stainless steel 1.4305 / 303
Enclosure rating	IP67 / IP69 ¹⁾
Probe diameter	8 mm
Probe length	60 mm
Minimum immersion length	12 mm
Distance to pipe wall	10 mm

¹⁾ Only with M12 male connector attached / not UL-tested.

Ambient data

Ambient operating temperature	-40 °C ... +70 °C ¹⁾
Ambient temperature, storage	-40 °C ... +80 °C

¹⁾ According to the UL approval: degree of contamination 3 (UL61010-1: 2012-05); air humidity: 80% at temperatures up to 31 °C; installation altitude: max. 3,000 m above sea level.

Classifications

ECLASS 5.0	27273101
ECLASS 5.1.4	27273101
ECLASS 6.0	27273101
ECLASS 6.2	27273101
ECLASS 7.0	27273101
ECLASS 8.0	27273101
ECLASS 8.1	27273101
ECLASS 9.0	27273101
ECLASS 10.0	27273101
ECLASS 11.0	27273101
ETIM 5.0	EC002580
ETIM 6.0	EC002580
ETIM 7.0	EC002580
ETIM 8.0	EC002580
UNSPSC 16.0901	41112501

Dimensional drawing (Dimensions in mm (inch))

FTS Hygienic

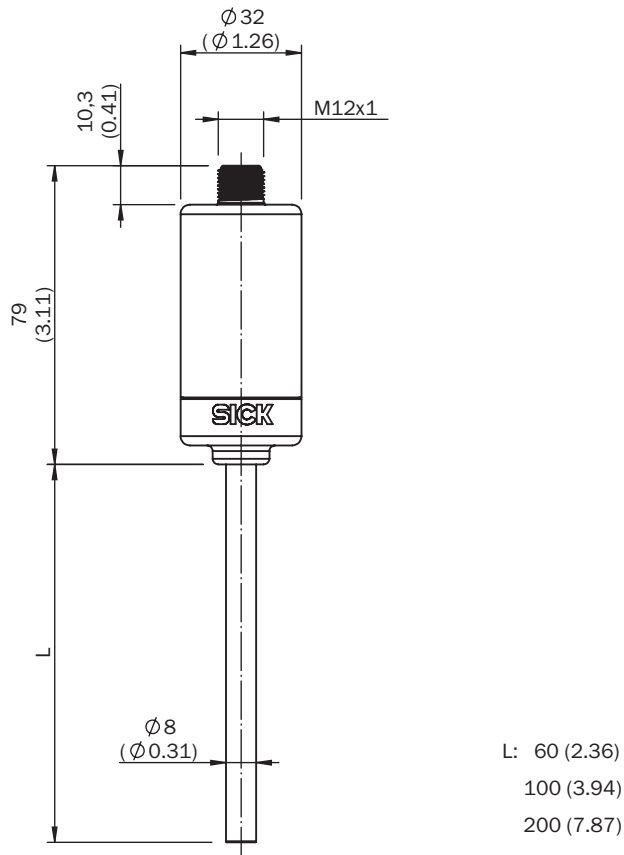

Recommended accessories

Other models and accessories → www.sick.com/T-Easic_FTS

	Brief description	Type	Part no.
Flanges			
	Hygienic process adapter for T-Easic FTS, conical coupling with grooved cap nut (DIN 11851), DN 25, Stainless steel 1.4404 / 316L	BEF-HA-851D25-FTS1	2136239
	Hygienic process adapter for T-Easic FTS, conical coupling with grooved cap nut (DIN 11851), DN 40, Stainless steel 1.4404 / 316L	BEF-HA-851D40-FTS1	2136240
	Hygienic process adapter for T-Easic FTS, conical coupling with grooved cap nut (DIN 11851), DN 50, Stainless steel 1.4404 / 316L	BEF-HA-851D50-FTS1	2136241
	Hygienic process adapter for T-Easic FTS, clamp (DIN 32676), DN 50 (2''), Stainless steel 1.4404 / 316L	BEF-HA-TCL120-FTS1	2136237
	Hygienic process adapter for T-Easic FTS, clamp (DIN 32676), DN 65 (3''), Stainless steel 1.4404 / 316L	BEF-HA-TCL125-FTS1	2136238

Recommended services

Additional services → www.sick.com/T-Easic_FTS

	Type	Part no.
Function Block Factory		
<ul style="list-style-type: none"> • Description: The Function Block Factory supports common programmable logic controllers (PLCs) from various manufacturers, such as Siemens, Beckhoff, Rockwell Automation and B&R. More information on the FBF can be found <a _blank"="" href="https://fbf.cloud.sick.com target=">here. • Note: You can configure your function block at <a _blank"="" href="https://fbf.cloud.sick.com target=">Function Block Factory. As a login please use your SICK ID. 	Function Block Factory	On request

SICK AT A GLANCE

SICK is one of the leading manufacturers of intelligent sensors and sensor solutions for industrial applications. A unique range of products and services creates the perfect basis for controlling processes securely and efficiently, protecting individuals from accidents and preventing damage to the environment.

We have extensive experience in a wide range of industries and understand their processes and requirements. With intelligent sensors, we can deliver exactly what our customers need. In application centers in Europe, Asia and North America, system solutions are tested and optimized in accordance with customer specifications. All this makes us a reliable supplier and development partner.

Comprehensive services complete our offering: SICK LifeTime Services provide support throughout the machine life cycle and ensure safety and productivity.

For us, that is “Sensor Intelligence.”

WORLDWIDE PRESENCE:

Contacts and other locations –www.sick.com