



GL2S-E1312

G2

MINIATURE PHOTOELECTRIC SENSORS

SICK
Sensor Intelligence.



Ordering information

| Type | Part no. |
|------------|----------|
| GL2S-E1312 | 1064424 |

Included in delivery: PL10F (1)

Other models and accessories → www.sick.com/G2

Illustration may differ



Detailed technical data

Features

| | |
|----------------------------------------|-------------------------------------------------------|
| Functional principle | Photoelectric retro-reflective sensor |
| Functional principle detail | With minimum distance to reflector (dual lens system) |
| Dimensions (W x H x D) | 7.7 mm x 21.8 mm x 13.5 mm |
| Housing design (light emission) | Rectangular |
| Sensing range max. | 0.02 m ... 3 m ¹⁾ |
| Sensing range | 0.03 m ... 2.5 m ¹⁾ |
| Type of light | Visible red light |
| Light source | PinPoint LED ²⁾ |
| Light spot size (distance) | Ø 11 mm (250 mm) |
| Wave length | 640 nm |
| Adjustment | None |

¹⁾ Reflector PL40A.

²⁾ Average service life: 100,000 h at T_J = +25 °C.

Mechanics/electronics

| | |
|-------------------------------------|-----------------------------------|
| Supply voltage U_B | 10 V DC ... 30 V DC ¹⁾ |
| Ripple | < 5 V _{pp} ²⁾ |

¹⁾ Limit values when operated in short-circuit protected network: max. 8 A.

²⁾ May not fall below or exceed U_V tolerances.

³⁾ Without load.

⁴⁾ Signal transit time with resistive load.

⁵⁾ With light/dark ratio 1:1.

⁶⁾ Do not bend below 0 °C.

⁷⁾ A = V_S connections reverse-polarity protected.

⁸⁾ C = interference suppression.

⁹⁾ D = outputs overcurrent and short-circuit protected.

| | |
|----------------------------------------|-------------------------------------------------------|
| Current consumption | 20 mA ³⁾ |
| Switching output | NPN |
| Switching mode | Dark switching |
| Output current I_{max.} | ≤ 50 mA |
| Response time | < 0.6 ms ⁴⁾ |
| Switching frequency | 800 Hz ⁵⁾ |
| Connection type | Cable, 3-wire, 2 m ⁶⁾ |
| Cable material | Plastic, PVC |
| Cable diameter | Ø 3 mm |
| Circuit protection | A ⁷⁾ C ⁸⁾ D ⁹⁾ |
| Weight | 37 g |
| Polarisation filter | ✓ |
| Housing material | Plastic, ABS |
| Optics material | Plastic, PMMA |
| Enclosure rating | IP67 |
| Items supplied | PL10F reflector |
| Ambient operating temperature | -25 °C ... +50 °C |
| Ambient temperature, storage | -40 °C ... +75 °C |
| UL File No. | NRKH.E181493 |

¹⁾ Limit values when operated in short-circuit protected network: max. 8 A.

²⁾ May not fall below or exceed U_y tolerances.

³⁾ Without load.

⁴⁾ Signal transit time with resistive load.

⁵⁾ With light/dark ratio 1:1.

⁶⁾ Do not bend below 0 °C.

⁷⁾ A = V_S connections reverse-polarity protected.

⁸⁾ C = interference suppression.

⁹⁾ D = outputs overcurrent and short-circuit protected.

Safety-related parameters

| | |
|-------------------------|-------------|
| MTTF_D | 3,378 years |
| DC_{avg} | 0 % |

Classifications

| | |
|---------------------|----------|
| ECLASS 5.0 | 27270902 |
| ECLASS 5.1.4 | 27270902 |
| ECLASS 6.0 | 27270902 |
| ECLASS 6.2 | 27270902 |
| ECLASS 7.0 | 27270902 |
| ECLASS 8.0 | 27270902 |
| ECLASS 8.1 | 27270902 |
| ECLASS 9.0 | 27270902 |
| ECLASS 10.0 | 27270902 |

| | |
|-----------------------|----------|
| ECLASS 11.0 | 27270902 |
| ECLASS 12.0 | 27270902 |
| ETIM 5.0 | EC002717 |
| ETIM 6.0 | EC002717 |
| ETIM 7.0 | EC002717 |
| ETIM 8.0 | EC002717 |
| UNSPSC 16.0901 | 39121528 |

Connection type

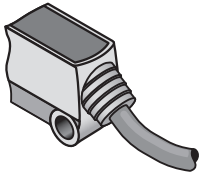

Connection diagram

Cd-043

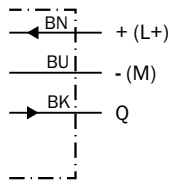

Characteristic curve

GL2S

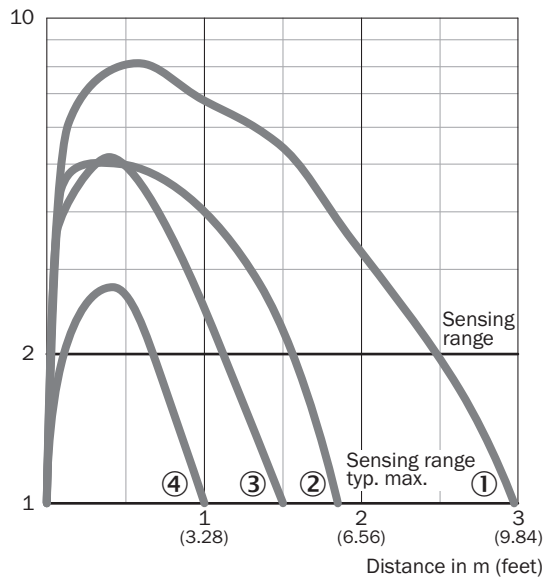

- ① Reflector PL40A
- ② Reflector PL20A
- ③ PL10F reflector
- ④ Reflective tape IREF6000 (REF-IRF-56)

Light spot size

GL2S

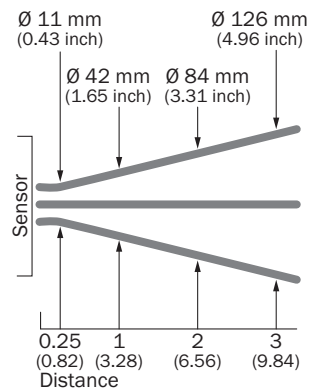

Sensing range diagram

GL2S

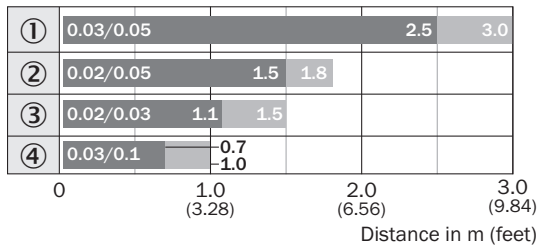

■ Sensing range ■ Sensing range typ. max.

- ① Reflector PL40A
- ② Reflector PL20A
- ③ PL10F reflector
- ④ Reflective tape IREF6000 (REF-IRF-56)

Dimensional drawing (Dimensions in mm (inch))

GL2S

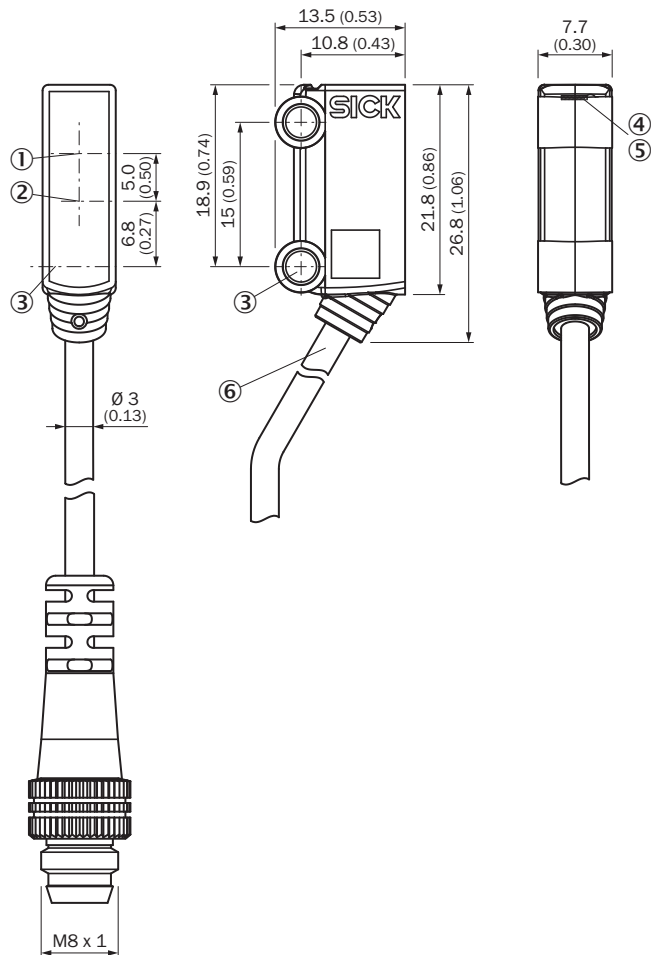

- ① Optical axis, receiver
- ② Optical axis, sender
- ③ Mounting hole, Ø 3.2 mm
- ④ LED indicator green: Supply voltage active
- ⑤ LED indicator yellow: Status of received light beam
- ⑥ Connection

Recommended accessories

Other models and accessories → www.sick.com/G2

| | Brief description | Type | Part no. |
|-------------------------------------------------------------------------------------|--------------------------------------------------------------------------------------------------------------------------|-------|----------|
| Reflectors | | | |
|  | Fine triple reflector, screw connection, suitable for laser sensors, 20 mm x 32 mm, PM-MA/ABS, Screw-on, 2 hole mounting | PL10F | 5311210 |

| | Brief description | Type | Part no. |
|-----------------------------------------------------------------------------------|-----------------------------------------------------------------------------------------------------------------------------------------------------------------------------------------------------------------------------------------------------------------------------------------------------------------------|------------|----------|
| Others | | | |
|  | <ul style="list-style-type: none">• Connection type head A: Male connector, M8, 3-pin, straight, A-coded• Description: Unshielded• Connection systems: Screw-type terminals• Permitted cross-section: 0.14 mm² ... 0.5 mm² | STE-0803-G | 6037322 |

SICK AT A GLANCE

SICK is one of the leading manufacturers of intelligent sensors and sensor solutions for industrial applications. A unique range of products and services creates the perfect basis for controlling processes securely and efficiently, protecting individuals from accidents and preventing damage to the environment.

We have extensive experience in a wide range of industries and understand their processes and requirements. With intelligent sensors, we can deliver exactly what our customers need. In application centers in Europe, Asia and North America, system solutions are tested and optimized in accordance with customer specifications. All this makes us a reliable supplier and development partner.

Comprehensive services complete our offering: SICK LifeTime Services provide support throughout the machine life cycle and ensure safety and productivity.

For us, that is “Sensor Intelligence.”

WORLDWIDE PRESENCE:

Contacts and other locations –www.sick.com