



GL6-P411S92

G6

MINIATURE PHOTOELECTRIC SENSORS

SICK
Sensor Intelligence.



Illustration may differ



Ordering information

| Type | Part no. |
|--------------|----------|
| GL6-P4111S92 | 1102163 |

Other models and accessories → www.sick.com/G6

Detailed technical data

Features

| | |
|------------------------------------|---|
| Functional principle | Photoelectric retro-reflective sensor |
| Functional principle detail | With minimum distance to reflector (dual lens system) |
| Sensing range max. | 0.03 m ... 6 m ¹⁾ |
| Sensing range | 0.07 m ... 5 m ¹⁾ |
| Polarisation filters | Yes |
| Emitted beam | |
| Light source | PinPoint LED ²⁾ |
| Type of light | Visible red light |
| Light spot size (distance) | Ø 8 mm (350 mm) |
| Key LED figures | |
| Wave length | 650 nm |
| Adjustment | None |
| Special features | Mounting holes, M3 un-threaded |

¹⁾ Reflector PL80A.

²⁾ Average service life: 100,000 h at T_J = +25 °C.

Safety-related parameters

| | |
|-------------------------------------|-------------|
| MTTF_D | 2,141 years |
| DC_{avg} | 0 % |
| T_M (mission time) | 20 years |

Electronics

| | |
|--|--|
| Supply voltage U_B | 10 V DC ... 30 V DC ¹⁾ |
| Ripple | $\pm 10\%$ ²⁾ |
| Current consumption | 30 mA ³⁾ |
| Protection class | III |
| Digital output | |
| Type | PNP |
| Switching mode | Light/dark switching |
| Switching mode selector | Selectable via light/dark selector |
| Signal voltage PNP HIGH/LOW | $V_S - (\leq 3\text{ V}) / \text{approx. } 0\text{ V}$ |
| Output current I_{max} | $\leq 100\text{ mA}$ ⁴⁾ |
| Response time | $< 625\ \mu\text{s}$ ⁵⁾ |
| Switching frequency | 1,000 Hz ⁶⁾ |
| Circuit protection | A ⁷⁾ B ⁸⁾ D ⁹⁾ |

¹⁾ Limit values when operated in short-circuit protected network: max. 8 A.

²⁾ May not fall below or exceed U_V tolerances.

³⁾ Without load.

⁴⁾ At $U_V > 24\text{ V}$, $I_A \text{ max.} = 50\text{ mA}$.

⁵⁾ Signal transit time with resistive load.

⁶⁾ With light/dark ratio 1:1.

⁷⁾ A = V_S connections reverse-polarity protected.

⁸⁾ B = inputs and output reverse-polarity protected.

⁹⁾ D = outputs overcurrent and short-circuit protected.

Mechanics

| | |
|-------------------------------|--------------------------|
| Housing | Rectangular |
| Dimensions (W x H x D) | 12 mm x 31.5 mm x 21 mm |
| Connection | Male connector M8, 4-pin |
| Material | |
| Housing | Plastic, ABS/PC |
| Front screen | Plastic, PMMA |
| Weight | 20 g |

Ambient data

| | |
|--------------------------------------|---|
| Enclosure rating | IP67 |
| Ambient operating temperature | $-25\text{ }^\circ\text{C} \dots +55\text{ }^\circ\text{C}$ ¹⁾ |
| Ambient temperature, storage | $-40\text{ }^\circ\text{C} \dots +70\text{ }^\circ\text{C}$ |
| UL File No. | NRKH.E348498 & NRKH7.E348498 |

¹⁾ Temperature stability following adjustment $\pm 10\text{ }^\circ\text{C}$.

Classifications

| | |
|---------------------|----------|
| ECLASS 5.0 | 27270902 |
| ECLASS 5.1.4 | 27270902 |

| | |
|-----------------------|----------|
| ECLASS 6.0 | 27270902 |
| ECLASS 6.2 | 27270902 |
| ECLASS 7.0 | 27270902 |
| ECLASS 8.0 | 27270902 |
| ECLASS 8.1 | 27270902 |
| ECLASS 9.0 | 27270902 |
| ECLASS 10.0 | 27270902 |
| ECLASS 11.0 | 27270902 |
| ECLASS 12.0 | 27270902 |
| ETIM 5.0 | EC002717 |
| ETIM 6.0 | EC002717 |
| ETIM 7.0 | EC002717 |
| ETIM 8.0 | EC002717 |
| UNSPSC 16.0901 | 39121528 |

Dimensional drawing (Dimensions in mm (inch))

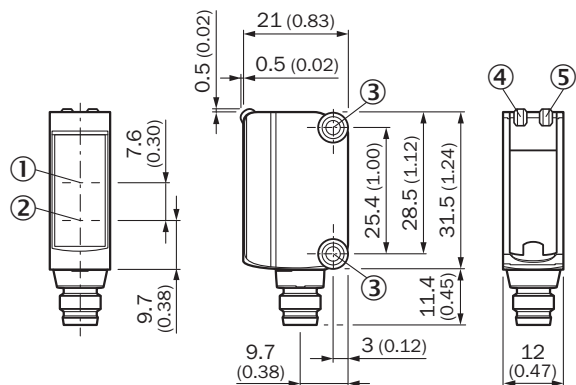

- ① Optical axis, receiver
- ② Optical axis, sender
- ③ Mounting holes, M3 un-threaded
- ④ LED indicator green: Supply voltage active
- ⑤ LED indicator yellow: Status of received light beam

Adjustments

No adjustment possibility

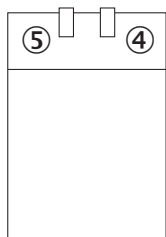

- ④ LED indicator green: Supply voltage active
- ⑤ LED indicator yellow: Status of received light beam

Connection type

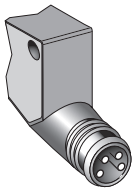

Connection diagram

Cd-066

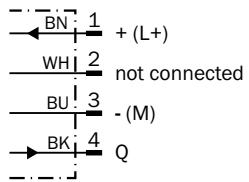

Characteristic curve

GL6

Operating reserve

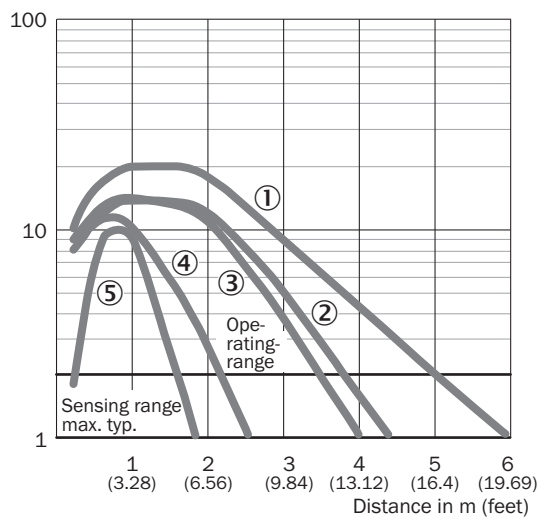

- ① Reflector PL80A
- ② Reflector PL40A
- ③ Reflector P250
- ④ Reflector PL20A
- ⑤ Reflective tape REF-IRF-56

Light spot size

GL6, GL6G

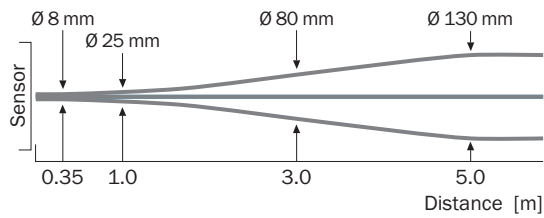

Sensing range diagram

GL6, GL6G

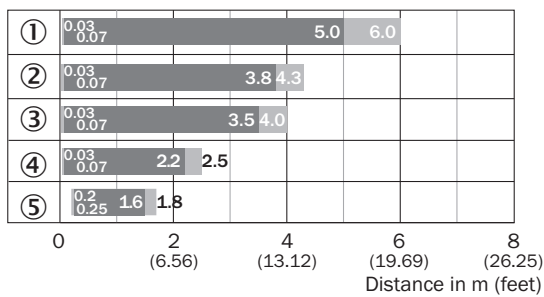

■ Sensing range



■ Sensing range max.

- ① Reflector PL80A
- ② Reflector PL40A
- ③ Reflector P250
- ④ Reflector PL20A
- ⑤ Reflective tape REF-IRF-56

Recommended accessories

Other models and accessories → www.sick.com/G6

| | Brief description | Type | Part no. |
|-------------------------------------|--|----------------|----------|
| Universal bar clamp systems | | | |
| | Clamp bar to fix G6 sensors on rods of 12 mm, clamp-on design up to 4 mm wall thickness, aluminum (clamp bar), stainless steel (bracket), clamp bar mounting and clamp function, mounting bracket, mounting hardware | BEF-KHS-IS12G6 | 2086865 |
| Mounting brackets and plates | | | |
| | Stainless steel (1.4301) | BEF-WN-G6 | 2062909 |
| | Universal mounting bracket for reflectors, steel, zinc coated | BEF-WN-REFX | 2064574 |

| | Brief description | Type | Part no. |
|---|--|--------------------|----------|
| Reflectors | | | |
|  | Rectangular, screw connection, 51 mm x 61 mm, PMMA/ABS, Screw-on, 2 hole mounting | P250 | 5304812 |
| Others | | | |
|  | <ul style="list-style-type: none"> • Connection type head A: Male connector, M8, 4-pin, straight, A-coded • Description: Unshielded • Connection systems: Screw-type terminals • Permitted cross-section: 0.14 mm² ... 0.5 mm² | STE-0804-G | 6037323 |
|  | <ul style="list-style-type: none"> • Connection type head A: Female connector, M8, 4-pin, straight, A-coded • Connection type head B: Flying leads • Signal type: Sensor/actuator cable • Cable: 5 m, 4-wire, PVC • Description: Sensor/actuator cable, unshielded • Application: Zones with chemicals, Uncontaminated zones | YF8U14-050VA3XLEAX | 2095889 |

SICK AT A GLANCE

SICK is one of the leading manufacturers of intelligent sensors and sensor solutions for industrial applications. A unique range of products and services creates the perfect basis for controlling processes securely and efficiently, protecting individuals from accidents and preventing damage to the environment.

We have extensive experience in a wide range of industries and understand their processes and requirements. With intelligent sensors, we can deliver exactly what our customers need. In application centers in Europe, Asia and North America, system solutions are tested and optimized in accordance with customer specifications. All this makes us a reliable supplier and development partner.

Comprehensive services complete our offering: SICK LifeTime Services provide support throughout the machine life cycle and ensure safety and productivity.

For us, that is “Sensor Intelligence.”

WORLDWIDE PRESENCE:

Contacts and other locations –www.sick.com