



GLD20G-1IRC2170ZZZ

G20

COMPACT PHOTOELECTRIC SENSORS

SICK
Sensor Intelligence.

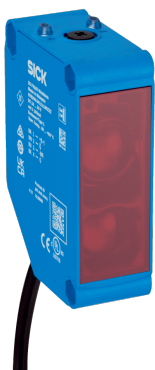

Illustration may differ



Ordering information

Type	Part no.
GLD20G-1IRC217OZZZ	1119873

Other models and accessories → www.sick.com/G20

Detailed technical data

Features

Functional principle	Photoelectric retro-reflective sensor
Functional principle detail	With minimum distance to reflector (dual lens system)
Sensing range	
Sensing range min.	0.03 m
Sensing range max.	20 m
Maximum distance range from reflector to sensor (operating reserve 1)	0.03 m ... 20 m
Recommended distance range from reflector to sensor (operating reserve 2)	0.03 m ... 16 m
Reference reflector	Reflector PL80A
Polarisation filters	Yes
Emitted beam	
Light source	LED
Type of light	Visible red light
Shape of light spot	Rectangular
Light spot size (distance)	Ø 200 mm (5,000 mm)
Maximum dispersion of the emitted beam around the standardized transmission axis (squint angle)	< +/- 1.5° (at T _a = +23 °C)
Key LED figures	
Normative reference	EN 62471:2008-09 IEC 62471:2006, modified
LED risk group marking	Free group
Wave length	630 nm
Average service life	100,000 h at T _a = +25 °C
Adjustment	
Potentiometer	For sensitivity adjustment, 270°

Indication	
LED green	Operating indicator Static on: power on Static off: object present
LED yellow	Status of received light beam Static on: object not present Static off: object present

Electrical data

Supply voltage U_e	24 V AC/DC ... 240 V AC/DC ¹⁾
Ripple	< 10 %
Usage category	DC-13 (according to EN 60947-1) AC-15 (according to EN 60947-1)
Current consumption	≤ 10 mA, ≤ 45 mA, Without load At 230 V AC/DC, Without load At 24 V AC/DC
Protection class	II
Digital output	
Number	2 (Complementary)
Type	Relay, SPDT, electrically isolated ²⁾
Switching mode	Light/dark switching
Output current I_{max}	4 A@250 V AC, 4 A@24 VDC, 0.11 A@250 V DCUL: 4 A@250 V AC, general use4 A @ 250 V AC, resistive (NO)3 A @ 250 V AC, resistive (NC)4 A @ 24 V DC, NO, general use3 A @ 24 V DC, NC, general useR300/B300 (NO contacts only)
Response time	≤ 15 ms
Switching frequency	10 Hz ³⁾
Pin/Wire assignment	
BN	L/(+)
BU	N/(-)
WH	Relay COM
BK	Relay NC Relay output, light switching, object present → output LOW
GY	Relay NO Relay output, dark switching, object present → output HIGH

¹⁾ ± 10 %.

²⁾ Valid only for devices manufactured before June 18, 2023 with a date code of 2324 or earlier. Suitable arc suppression with inductive or capacitive load. Relay contacts are separated from the supply voltage by a base insulation of 3.2 mm. Depending on the application, additional insulation may be required in the user wiring.

³⁾ With light/dark ratio 1:1.

Mechanical data

Housing	Rectangular
Dimensions (W x H x D)	23.5 mm x 74.5 mm x 63 mm
Connection	Cable, 5-wire, 2 m
Connection detail	
Deep-freeze property	Do not bend below 0 °C
Conductor size	0.32 mm ²
Cable diameter	∅ 5 mm
Length of cable (L)	2 m
Material	
Housing	Plastic, ABS

	Front screen	Plastic, PMMA
	Cable	Plastic, PVC
Weight		Approx. 153 g

Ambient data

Enclosure rating	IP67 (EN 60529)
Ambient operating temperature	-30 °C ... +60 °C ¹⁾
Ambient temperature, storage	-40 °C ... +70 °C
Typ. Ambient light immunity	Sunlight: ≤ 20,000 lx
Shock resistance	30 g, 11 ms (3 positive and 3 negative shocks along X, Y, Z axes, 18 total shocks (EN60068-2-27))
Vibration resistance	10 Hz ... 1,000 Hz (Amplitude 1 mm, 3 x 30 min (EN60068-2-6))
Air humidity	35 % ... 95 %, relative humidity (no condensation)
Electromagnetic compatibility (EMC)	EN 60947-5-2, EN 61000-6-3
UL File No.	NRKH.E348498 & NRKH7.E348498

¹⁾ The max. ambient temperature is 50 °C (UL).

Classifications

ECLASS 5.0	27270902
ECLASS 5.1.4	27270902
ECLASS 6.0	27270902
ECLASS 6.2	27270902
ECLASS 7.0	27270902
ECLASS 8.0	27270902
ECLASS 8.1	27270902
ECLASS 9.0	27270902
ECLASS 10.0	27270902
ECLASS 11.0	27270902
ECLASS 12.0	27270904
ETIM 5.0	EC002717
ETIM 6.0	EC002717
ETIM 7.0	EC002717
ETIM 8.0	EC002717
UNSPSC 16.0901	39121528

Adjustments

Display and adjustment elements



② LED yellow

Display and adjustment elements



- ① LED green
- ② LED yellow
- ③ Potentiometer

Connection type

Cable, 5-wire

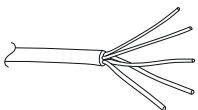

Connection diagram

Cd-579

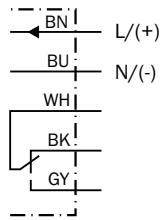

Characteristic curve

Operating reserve

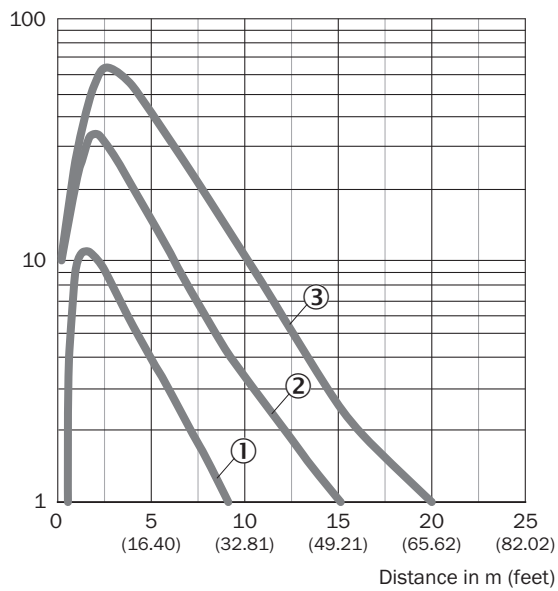

- ① Reflector PL20A
- ② Reflector PL50A, P250, PL30A, PL31A, PL40A
- ③ Reflector PL80A, C110A, PL100

Operating reserve

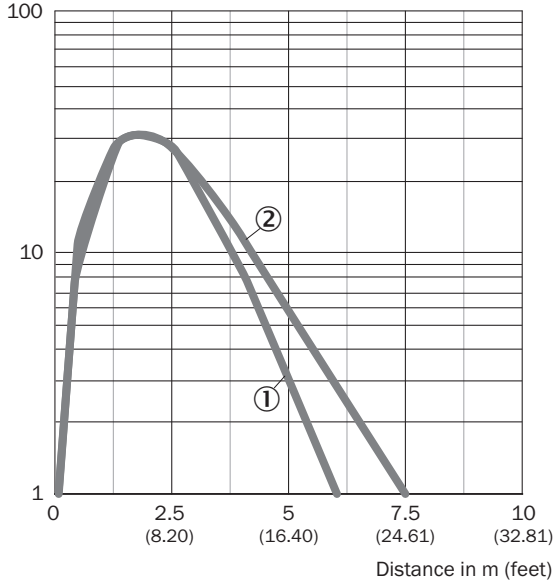

- ① Reflective tape REF-IRF-56
- ② Diamond Grade reflective tape, 100 mm x 100 mm

Light spot size

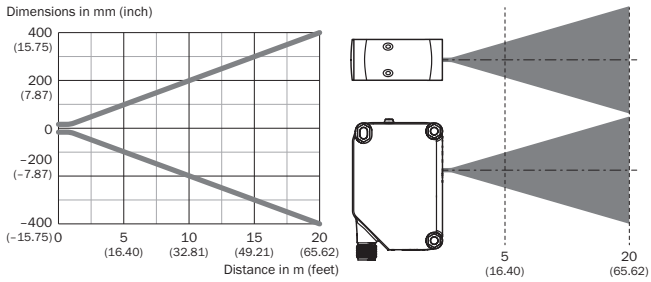

Sensing range diagram

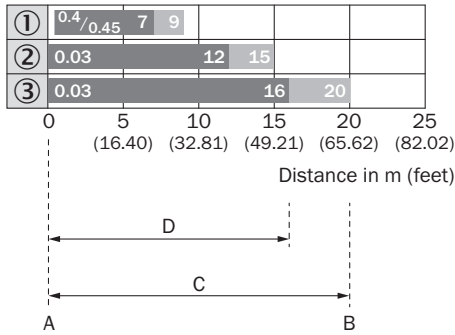

1	Reflector PL20A
2	Reflector PL50A, P250, PL30A, PL31A, PL40A

3	Reflector PL80A, C110A, PL100
A	Sensing range min. in m
B	Sensing range max. in m
C	Maximum distance range from reflector to sensor (operating reserve 1)
D	Recommended distance range from reflector to sensor (operating reserve 2)

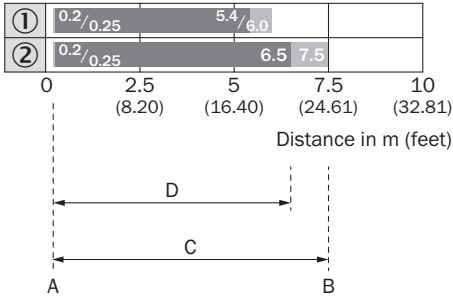

1	Reflective tape REF-IRF-56
2	Diamond Grade reflective tape, 100 mm x 100 mm
A	Sensing range min. in m
B	Sensing range max. in m
C	Maximum distance range from reflector to sensor (operating reserve 1)
D	Recommended distance range from reflector to sensor (operating reserve 2)

Dimensional drawing (Dimensions in mm (inch))

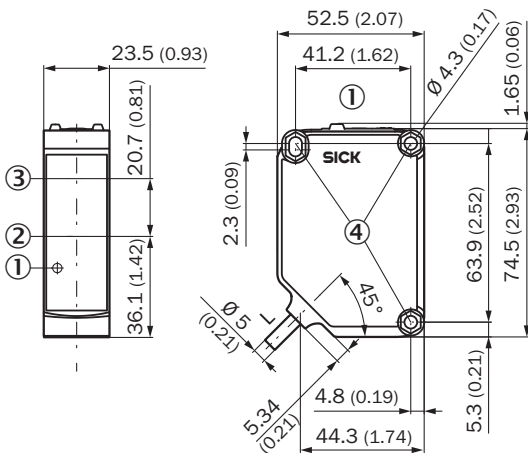





For length of cable (L), see technical data

- ① Display and adjustment elements
- ② Center of optical axis, sender
- ③ Center of optical axis, receiver
- ④ Fixing hole \varnothing 4.3 mm, both sides for hexagon nut M4

Recommended accessories

Other models and accessories → www.sick.com/G20

	Brief description	Type	Part no.
Mounting brackets and plates			
	Mounting bracket, Stainless steel V2A (1.4301), 2 screws, 2 nuts, 2 circlips, 2 washers for mounting the sensor	BEF-W280	5313885
	Universal mounting bracket for reflectors, steel, zinc coated	BEF-WN-REFX	2064574
Reflectors			
	Rectangular, screw connection, 84 mm x 84 mm, PMMA/ABS, Screw-on, 2 hole mounting	PL80A	1003865
Others			
	<ul style="list-style-type: none"> • Connection type head A: Male connector, M12, 5-pin, straight, A-coded • Description: Unshielded, Head A: male connector, M12, 5-pin, straight, unshielded, for cable diameter 4 mm ... 6 mm Head B: - • Connection systems: Screw-type terminals • Permitted cross-section: ≤ 0.75 mm² • Note: For field bus technology 	STE-1205-G	6022083

SICK AT A GLANCE

SICK is one of the leading manufacturers of intelligent sensors and sensor solutions for industrial applications. A unique range of products and services creates the perfect basis for controlling processes securely and efficiently, protecting individuals from accidents and preventing damage to the environment.

We have extensive experience in a wide range of industries and understand their processes and requirements. With intelligent sensors, we can deliver exactly what our customers need. In application centers in Europe, Asia and North America, system solutions are tested and optimized in accordance with customer specifications. All this makes us a reliable supplier and development partner.

Comprehensive services complete our offering: SICK LifeTime Services provide support throughout the machine life cycle and ensure safety and productivity.

For us, that is “Sensor Intelligence.”

WORLDWIDE PRESENCE:

Contacts and other locations –www.sick.com