



GLL170T-B434

GLL170

FIBER-OPTIC AMPLIFIER

SICK
Sensor Intelligence.



Illustration may differ



Ordering information

Type	Part no.
GLL170T-B434	6063341

Other models and accessories → www.sick.com/GLL170

Detailed technical data

Features

Device type	Fiber-optic amplifier
Device type detail	Stand-alone
Dimensions (W x H x D)	10 mm x 31.7 mm x 72.5 mm
Housing design (light emission)	Rectangular
Sensing range max.	0 mm ... 400 mm (Proximity system) ^{1) 2)} 0 mm ... 1,320 mm (Through-beam system) ³⁾
Sensing range	0 mm ... 350 mm, Proximity system ^{1) 2)} 0 mm ... 1,100 mm, Through-beam system ³⁾
Type of light	Visible red light
Light source	LED ⁴⁾
Wave length	632 nm
Adjustment	Teach-in button Cable Plus/minus button
Indication	7-segment
Display	Status LEDs, 4-digit digital display, display selectable between percentage value, absolute digit value and bar display / display of parameters

¹⁾ Object with 90% remission (based on standard white, DIN 5033).

²⁾ LL3-DK06.

³⁾ LL3-TB02.

⁴⁾ Average service life: 100,000 h at T_U = +25 °C.

Mechanics/electronics

Supply voltage U_B	10 V DC ... 30 V DC ¹⁾
Ripple	$\leq 10\%$ ²⁾
Current consumption	40 mA ³⁾
Switching output	PNP, NPN, Selectable via menu
Number of switching outputs	1
Switching mode	Light/dark switching
Switching mode selector	Selectable via menu
Response time	$\leq 250\ \mu\text{s}$, $\leq 50\ \mu\text{s}$, Selectable via menu ^{4) 4)}
Switching frequency	2 kHz, 10 kHz
Time functions	Switch-on delayoff delayone shotWithout time delay
Delay time	Programmable, 0 ms ... 9,999 ms
Input	Teach-in input
Connection type	Male connector M8, 4-pin
Cable material	Plastic, PVC
Conductor cross section	0.2 mm ²
Cable diameter	$\varnothing 3.8\ \text{mm}$
Circuit protection	A ⁵⁾ B ⁶⁾ C ⁷⁾ D ⁸⁾
Protection class	III
Weight	22 g
Housing material	Plastic, PC/POM
Tightening torque, max.	0.5 Nm
Enclosure rating	IP66 ⁹⁾
Ambient operating temperature	-25 °C ... +55 °C
Ambient temperature, storage	-40 °C ... +70 °C
UL File No.	NRKH2.E300503 & NRKH8.E300503

¹⁾ Limit values.

²⁾ May not fall below or exceed U_V tolerances.

³⁾ Without load.

⁴⁾ Signal transit time with resistive load.

⁵⁾ A = V_S connections reverse-polarity protected.

⁶⁾ B = inputs and output reverse-polarity protected.

⁷⁾ C = interference suppression.

⁸⁾ D = outputs overcurrent and short-circuit protected.

⁹⁾ With correctly attached fibre-optic cable LL3.

Safety-related parameters

MTTF_D	300 years
DC_{avg}	0 %

Classifications

ECLASS 5.0	27270905
-------------------	----------

ECLASS 5.1.4	27270905
ECLASS 6.0	27270905
ECLASS 6.2	27270905
ECLASS 7.0	27270905
ECLASS 8.0	27270905
ECLASS 8.1	27270905
ECLASS 9.0	27270905
ECLASS 10.0	27270905
ECLASS 11.0	27270905
ECLASS 12.0	27270905
ETIM 5.0	EC002651
ETIM 6.0	EC002651
ETIM 7.0	EC002651
ETIM 8.0	EC002651
UNSPSC 16.0901	39121528

Adjustments

GLL170T

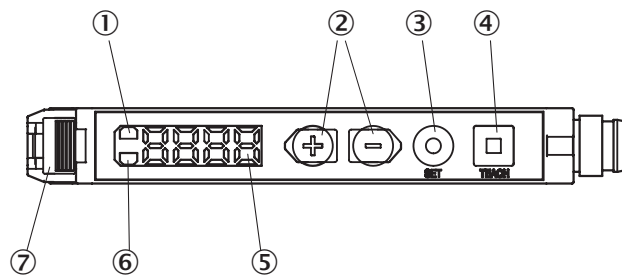

- ① LED indicator orange, lights up when switching output is active
- ② Plus/minus button
- ③ SET button
- ④ Teach-in button
- ⑤ Display
- ⑥ LED indicator green: Supply voltage active
- ⑦ Locking the fiber-optic cables

Connection diagram

Cd-092

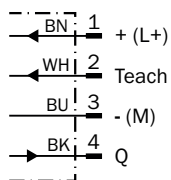



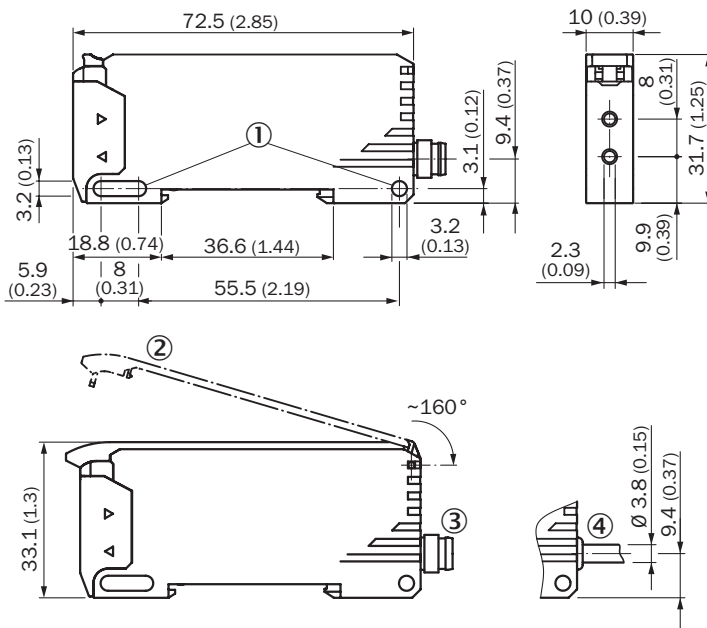

Dimensional drawing (Dimensions in mm (inch))







- ① Mounting holes
- ② Protective hood (optional), opens approx. 160°
- ③ Connector M8
- ④ Cable

Recommended accessories

Other models and accessories → www.sick.com/GLL170

	Brief description	Type	Part no.
Device protection (mechanical)			
	Protective Hood for GLL170, opens approx. 160°, PC	BF-GLL170	5336263
Mounting brackets and plates			
	Mounting bracket, steel, zinc coated, without mounting hardware	BEF-WLL180	5325812
Others			
	<ul style="list-style-type: none"> • Connection type head A: Female connector, M8, 4-pin, straight, A-coded • Description: Unshielded • Connection systems: Screw-type terminals • Permitted cross-section: 0.14 mm² ... 0.5 mm² 	DOS-0804-G	6009974
	<ul style="list-style-type: none"> • Connection type head A: Female connector, M8, 4-pin, angled, A-coded • Description: Unshielded • Connection systems: Solder connection • Permitted cross-section: ≤ 0.25 mm² 	DOS-0804-W	6009975
	<ul style="list-style-type: none"> • Connection type head A: Male connector, M8, 4-pin, straight, A-coded • Description: Unshielded • Connection systems: Screw-type terminals • Permitted cross-section: 0.14 mm² ... 0.5 mm² 	STE-0804-G	6037323

	Brief description	Type	Part no.
	<ul style="list-style-type: none"> • Connection type head A: Female connector, M8, 4-pin, straight, A-coded • Connection type head B: Flying leads • Signal type: Sensor/actuator cable • Cable: 2 m, 4-wire, PVC • Description: Sensor/actuator cable, unshielded • Application: Zones with chemicals 	YF8U14-020VA3XLEAX	2095888
	<ul style="list-style-type: none"> • Connection type head A: Female connector, M8, 4-pin, straight, A-coded • Connection type head B: Flying leads • Signal type: Sensor/actuator cable • Cable: 5 m, 4-wire, PVC • Description: Sensor/actuator cable, unshielded • Application: Zones with chemicals 	YF8U14-050VA3XLEAX	2095889
	<ul style="list-style-type: none"> • Connection type head A: Female connector, M8, 4-pin, straight, A-coded • Connection type head B: Flying leads • Signal type: Sensor/actuator cable • Cable: 10 m, 4-wire, PVC • Description: Sensor/actuator cable, unshielded • Application: Zones with chemicals 	YF8U14-100VA3XLEAX	2095890
	<ul style="list-style-type: none"> • Connection type head A: Female connector, M8, 4-pin, angled, A-coded • Connection type head B: Flying leads • Signal type: Sensor/actuator cable • Cable: 2 m, 4-wire, PVC • Description: Sensor/actuator cable, unshielded • Application: Zones with chemicals 	YG8U14-020VA3XLEAX	2095962
	<ul style="list-style-type: none"> • Connection type head A: Female connector, M8, 4-pin, angled, A-coded • Connection type head B: Flying leads • Signal type: Sensor/actuator cable • Cable: 5 m, 4-wire, PVC • Description: Sensor/actuator cable, unshielded • Application: Zones with chemicals 	YG8U14-050VA3XLEAX	2095963
	<ul style="list-style-type: none"> • Connection type head A: Female connector, M8, 4-pin, angled, A-coded • Connection type head B: Flying leads • Signal type: Sensor/actuator cable • Cable: 10 m, 4-wire, PVC • Description: Sensor/actuator cable, unshielded • Application: Zones with chemicals 	YG8U14-100VA3XLEAX	2095964
Fibers			
	LL3-DB01	LL3-DB01	5308074
	LL3-DB02	LL3-DB02	5308083
	LL3-DC38	LL3-DC38	5322472
	LL3-DR11	LL3-DR11	5326000
	LL3-DT01	LL3-DT01	5308076
	LL3-DV05	LL3-DV05	5322549
	LL3-TB01	LL3-TB01	5308050
	LL3-TH08	LL3-TH08	5325978
	LL3-TS40	LL3-TS40	5323971
	LL3-TV05	LL3-TV05	5322546
	LL3-TX01	LL3-TX01	5324173
	LL3-TY01	LL3-TY01	5308066

SICK AT A GLANCE

SICK is one of the leading manufacturers of intelligent sensors and sensor solutions for industrial applications. A unique range of products and services creates the perfect basis for controlling processes securely and efficiently, protecting individuals from accidents and preventing damage to the environment.

We have extensive experience in a wide range of industries and understand their processes and requirements. With intelligent sensors, we can deliver exactly what our customers need. In application centers in Europe, Asia and North America, system solutions are tested and optimized in accordance with customer specifications. All this makes us a reliable supplier and development partner.

Comprehensive services complete our offering: SICK LifeTime Services provide support throughout the machine life cycle and ensure safety and productivity.

For us, that is “Sensor Intelligence.”

WORLDWIDE PRESENCE:

Contacts and other locations –www.sick.com