



GRSE18S-P2442

GR18

CYLINDRICAL PHOTOELECTRIC SENSORS

SICK
Sensor Intelligence.



Ordering information

| Type | Part no. |
|---------------|----------|
| GRSE18S-P2442 | 1069125 |

Other models and accessories → www.sick.com/GR18

Illustration may differ



Detailed technical data

Features

| | |
|--|--|
| Functional principle | Through-beam photoelectric sensor |
| Dimensions (W x H x D) | 18 mm x 18 mm x 38.1 mm |
| Housing design (light emission) | Cylindrical |
| Thread diameter (housing) | M18 x 1 |
| Optical axis | Axial |
| Sensing range max. | 0 m ... 15 m |
| Sensing range | 0 m ... 10 m |
| Type of light | Visible red light |
| Light source | PinPoint LED ¹⁾ |
| Light spot size (distance) | Ø 250 mm (10 m) |
| Wave length | 650 nm |
| Adjustment | Potentiometer, 270° Potentiometer |
| Indication | |
| | LED green Operating indicator Static on: power on |
| | LED yellow Status of received light beam Static on: object not present Static off: object present |

¹⁾ Average service life: 100,000 h at T_J = +25 °C.

Mechanics/electronics

| | |
|---|---|
| Supply voltage U_B | 10 V DC ... 30 V DC ¹⁾ |
| Ripple | < 5 V _{pp} ²⁾ |
| Current consumption | 30 mA |
| Switching output | PNP |
| Output function | Complementary |
| Switching mode | Light/dark switching |
| Output current I_{max} | ≤ 100 mA ³⁾ |
| Response time | < 500 μs ⁴⁾ |
| Switching frequency | 1,000 Hz ⁵⁾ |
| Connection type | Male connector M12, 4-pin |
| Circuit protection | A ⁶⁾ B ⁷⁾ D ⁸⁾ |
| Protection class | III |
| Housing material | Metal, Nickel-plated brass and ABS |
| Optics material | Plastic, PMMA |
| Enclosure rating | IP67 |
| Items supplied | Fastening nuts (4 x) |
| Electromagnetic compatibility (EMC) | EN 60947-5-2 |
| Test input | Sender OFF at "Test" 0 V |
| Ambient operating temperature | -25 °C ... +55 °C ⁹⁾ |
| Ambient temperature, storage | -40 °C ... +70 °C |
| UL File No. | NRKH.E348498 & NRKH7.E348498 |
| Part number of individual components | 2075628 GRS18S-D2341 2075657 GRE18S-P2432 |

¹⁾ Limit values. Operated in short-circuit protected network: max. 8 A.

²⁾ May not fall below or exceed U_V tolerances.

³⁾ At $U_V > 24$ V or ambient temperature > 49 °C, I_A max. = 50 mA.

⁴⁾ Signal transit time with resistive load.

⁵⁾ With light/dark ratio 1:1.

⁶⁾ A = V_S connections reverse-polarity protected.

⁷⁾ B = inputs and output reverse-polarity protected.

⁸⁾ D = outputs overcurrent and short-circuit protected.

⁹⁾ At $U_V \leq 24$ V and $I_A < 50$ mA.

Classifications

| | |
|---------------------|----------|
| ECLASS 5.0 | 27270901 |
| ECLASS 5.1.4 | 27270901 |
| ECLASS 6.0 | 27270901 |
| ECLASS 6.2 | 27270901 |
| ECLASS 7.0 | 27270901 |
| ECLASS 8.0 | 27270901 |
| ECLASS 8.1 | 27270901 |
| ECLASS 9.0 | 27270901 |

| | |
|-----------------------|----------|
| ECLASS 10.0 | 27270901 |
| ECLASS 11.0 | 27270901 |
| ECLASS 12.0 | 27270901 |
| ETIM 5.0 | EC002716 |
| ETIM 6.0 | EC002716 |
| ETIM 7.0 | EC002716 |
| ETIM 8.0 | EC002716 |
| UNSPSC 16.0901 | 39121528 |

Adjustments

GRL18(S), GRSE18(S), Sensitivity setting: Potentiometer, 270°

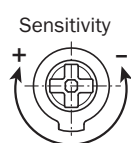

Connection diagram

Cd-072

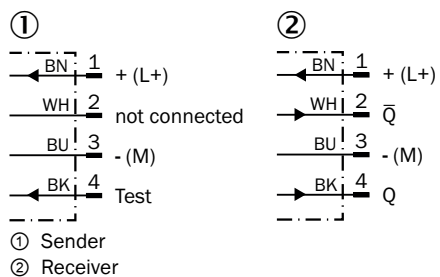

Characteristic curve

GRSE18S

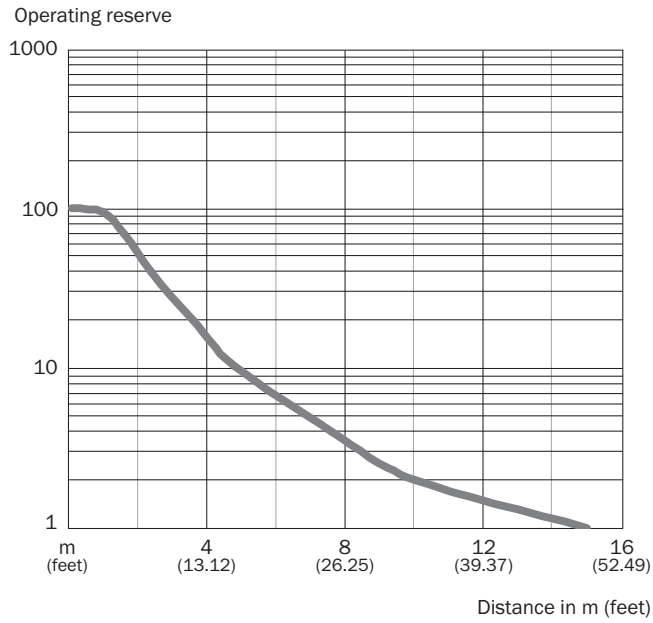

Light spot size

GRSE18, red light

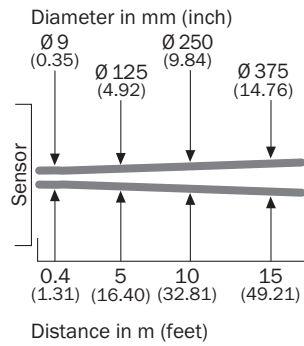

Sensing range diagram

GRSE18S

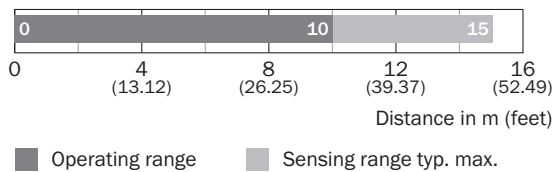

Response range

GRSE18S

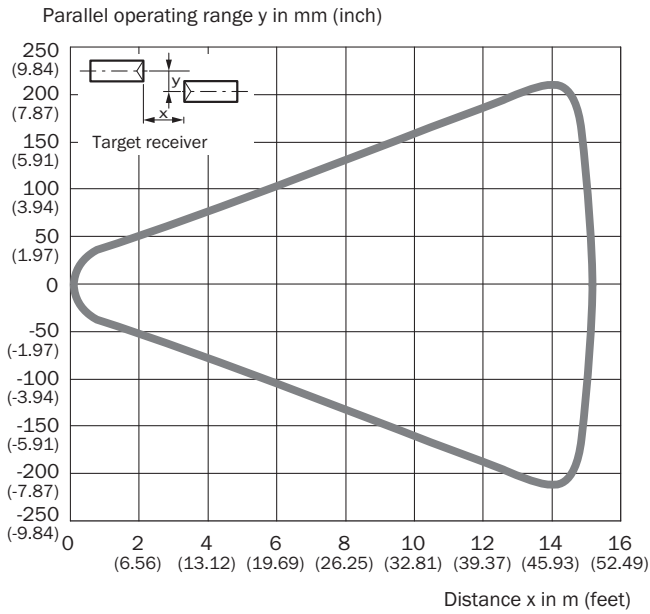

Dimensional drawing (Dimensions in mm (inch))

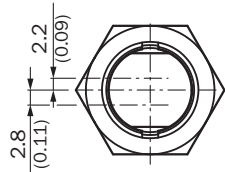
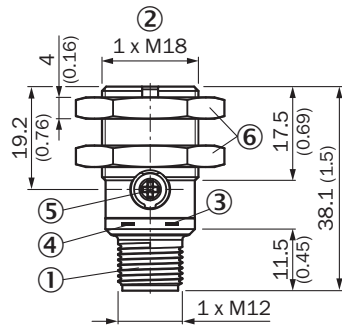

GR18S, metal, connector, straight, adjustable



- ① Connector M12, 3-pin
- ② Threaded mounting hole M18 x 1
- ③ LED indicator yellow
- ④ LED indicator green
- ⑤ Sensitivity control: potentiometer 270°
- ⑥ Fastening nuts (2x); width across 24, metal

Recommended accessories

Other models and accessories → www.sick.com/GR18

| | Brief description | Type | Part no. |
|---|---|--------------------|----------|
| Mounting brackets and plates | | | |
|  | Mounting bracket for M18 sensors, steel, zinc coated, without mounting hardware | BEF-WN-M18 | 5308446 |
| Others | | | |
|  | <ul style="list-style-type: none"> • Connection type head A: Female connector, M12, 4-pin, straight, A-coded • Connection type head B: Flying leads • Signal type: Sensor/actuator cable • Cable: 5 m, 4-wire, PVC • Description: Sensor/actuator cable, unshielded • Application: Zones with chemicals | YF2A14-050VB3XLEAX | 2096235 |
|  | <ul style="list-style-type: none"> • Connection type head A: Male connector, M12, 4-pin, straight, A-coded • Description: Unshielded • Connection systems: Screw-type terminals • Permitted cross-section: ≤ 0.75 mm² | STE-1204-G | 6009932 |

SICK AT A GLANCE

SICK is one of the leading manufacturers of intelligent sensors and sensor solutions for industrial applications. A unique range of products and services creates the perfect basis for controlling processes securely and efficiently, protecting individuals from accidents and preventing damage to the environment.

We have extensive experience in a wide range of industries and understand their processes and requirements. With intelligent sensors, we can deliver exactly what our customers need. In application centers in Europe, Asia and North America, system solutions are tested and optimized in accordance with customer specifications. All this makes us a reliable supplier and development partner.

Comprehensive services complete our offering: SICK LifeTime Services provide support throughout the machine life cycle and ensure safety and productivity.

For us, that is “Sensor Intelligence.”

WORLDWIDE PRESENCE:

Contacts and other locations –www.sick.com