



# GRTB18-P2412

GR18

CYLINDRICAL PHOTOELECTRIC SENSORS

**SICK**  
Sensor Intelligence.



Illustration may differ



### Ordering information

Type	Part no.
GRTB18-P2412	1076117

Other models and accessories → [www.sick.com/GR18](http://www.sick.com/GR18)

### Detailed technical data

#### Features

<b>Functional principle</b>	Photoelectric proximity sensor
<b>Functional principle detail</b>	Background suppression
<b>Dimensions (W x H x D)</b>	18 mm x 18 mm x 73.5 mm
<b>Housing design (light emission)</b>	Cylindrical
<b>Thread diameter (housing)</b>	M18 x 1
<b>Optical axis</b>	Axial
<b>Sensing range max.</b>	3 mm ... 300 mm <sup>1)</sup>
<b>Sensing range</b>	20 mm ... 150 mm <sup>1)</sup>
<b>Type of light</b>	Visible red light
<b>Light source</b>	PinPoint LED <sup>2)</sup>
<b>Light spot size (distance)</b>	Ø 7 mm (100 mm)
<b>Wave length</b>	650 nm
<b>Adjustment</b>	Potentiometer
<b>Indication</b>	
	LED green Operating indicator Static on: power on
	LED yellow Status of received light beam Static on: object present Static off: object not present

<sup>1)</sup> Object with 90% remission (based on standard white, DIN 5033).

<sup>2)</sup> Average service life: 100,000 h at T<sub>U</sub> = +25 °C.

## Mechanics/electronics

<b>Supply voltage <math>U_B</math></b>	10 V DC ... 30 V DC <sup>1)</sup>
<b>Ripple</b>	< 5 V <sub>pp</sub> <sup>2)</sup>
<b>Current consumption</b>	30 mA
<b>Switching output</b>	PNP
<b>Output function</b>	Complementary
<b>Switching mode</b>	Light/dark switching
<b>Signal voltage PNP HIGH/LOW</b>	V <sub>S</sub> - (≤ 3 V) / approx. 0 V
<b>Output current I<sub>max.</sub></b>	≤ 100 mA <sup>3)</sup>
<b>Response time</b>	< 500 μs <sup>4)</sup>
<b>Switching frequency</b>	1,000 Hz <sup>5)</sup>
<b>Connection type</b>	Male connector M12, 4-pin
<b>Circuit protection</b>	A <sup>6)</sup> B <sup>7)</sup> D <sup>8)</sup>
<b>Protection class</b>	III
<b>Housing material</b>	Metal, Nickel-plated brass and ABS
<b>Optics material</b>	Plastic, PMMA
<b>Enclosure rating</b>	IP67
<b>Items supplied</b>	Fastening nuts (2 x)
<b>Electromagnetic compatibility (EMC)</b>	EN 60947-5-2
<b>Ambient operating temperature</b>	-25 °C ... +55 °C <sup>9)</sup>
<b>Ambient temperature, storage</b>	-40 °C ... +70 °C
<b>UL File No.</b>	E348498

<sup>1)</sup> Limit values. Operated in short-circuit protected network: max. 8 A.

<sup>2)</sup> May not fall below or exceed U<sub>y</sub> tolerances.

<sup>3)</sup> At U<sub>v</sub> > 24 V or ambient temperature > 49 °C, I<sub>A</sub> max. = 50 mA.

<sup>4)</sup> Signal transit time with resistive load.

<sup>5)</sup> With light/dark ratio 1:1.

<sup>6)</sup> A = V<sub>S</sub> connections reverse-polarity protected.

<sup>7)</sup> B = inputs and output reverse-polarity protected.

<sup>8)</sup> D = outputs overcurrent and short-circuit protected.

<sup>9)</sup> At U<sub>v</sub> ≤ 24V and I<sub>A</sub> < 50mA.

## Safety-related parameters

<b>MTTF<sub>D</sub></b>	985 years
<b>DC<sub>avg</sub></b>	0 %

## Classifications

<b>ECLASS 5.0</b>	27270904
<b>ECLASS 5.1.4</b>	27270904
<b>ECLASS 6.0</b>	27270904
<b>ECLASS 6.2</b>	27270904
<b>ECLASS 7.0</b>	27270904

<b>ECLASS 8.0</b>	27270904
<b>ECLASS 8.1</b>	27270904
<b>ECLASS 9.0</b>	27270904
<b>ECLASS 10.0</b>	27270904
<b>ECLASS 11.0</b>	27270904
<b>ECLASS 12.0</b>	27270903
<b>ETIM 5.0</b>	EC002719
<b>ETIM 6.0</b>	EC002719
<b>ETIM 7.0</b>	EC002719
<b>ETIM 8.0</b>	EC002719
<b>UNSPSC 16.0901</b>	39121528

## Adjustments

GRTB18(S), GRTE18(S), Sensing range setting: Potentiometer, 270°

Sensing range

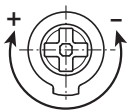

## Connection diagram

Cd-084

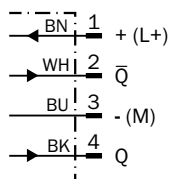

### Characteristic curve

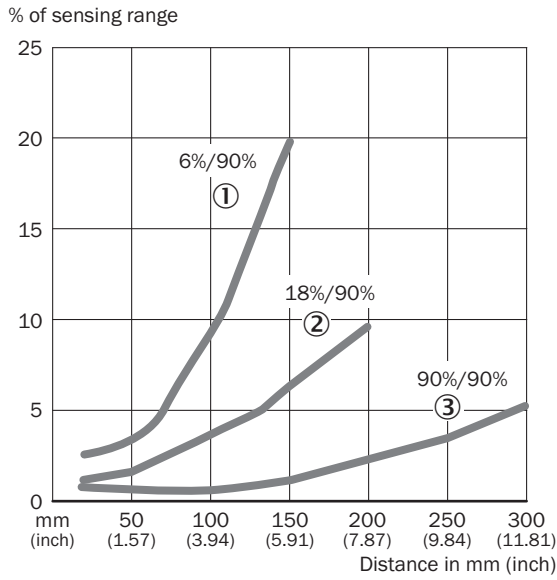

- ① Sensing range on black, 6% remission factor
- ② Sensing range on gray, 18% remission factor
- ③ Sensing range on white, 90% remission factor

### Light spot size

GRTB18(S)

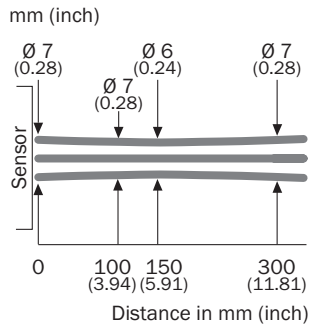

### Sensing range diagram

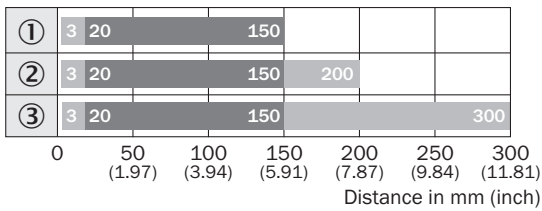

■ Sensing range      ■ Sensing range max.

- ① Sensing range on black, 6% remission factor
- ② Sensing range on gray, 18% remission factor
- ③ Sensing range on white, 90% remission factor

## Dimensional drawing (Dimensions in mm (inch))

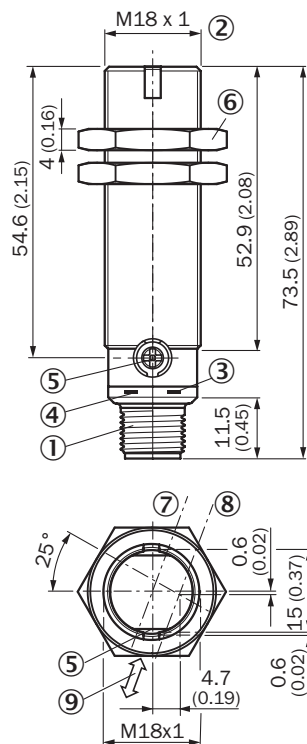

GRTB18, metal, connector, straight



- ① Male connector M12, 4-pin
- ② Threaded mounting hole M18 x 1
- ③ LED indicator yellow
- ④ LED indicator green
- ⑤ Sensitivity control: potentiometer 270°
- ⑥ Fastening nuts (2x); width across 24, metal
- ⑦ Optical axis, receiver
- ⑧ Optical axis, sender
- ⑨ Standard direction of the material being detected

## Recommended accessories

Other models and accessories → [www.sick.com/GR18](http://www.sick.com/GR18)

	Brief description	Type	Part no.
Mounting brackets and plates			
	Mounting bracket for M18 sensors, steel, zinc coated, without mounting hardware	BEF-WN-M18	5308446
Others			
	<ul style="list-style-type: none"> <li>• <b>Connection type head A:</b> Female connector, M12, 4-pin, straight, A-coded</li> <li>• <b>Connection type head B:</b> Flying leads</li> <li>• <b>Signal type:</b> Sensor/actuator cable</li> <li>• <b>Cable:</b> 5 m, 4-wire, PVC</li> <li>• <b>Description:</b> Sensor/actuator cable, unshielded</li> <li>• <b>Application:</b> Zones with chemicals</li> </ul>	YF2A14-050VB3XLEAX	2096235

	Brief description	Type	Part no.
	<ul style="list-style-type: none"><li>• <b>Connection type head A:</b> Male connector, M12, 4-pin, straight, A-coded</li><li>• <b>Description:</b> Unshielded</li><li>• <b>Connection systems:</b> Screw-type terminals</li><li>• <b>Permitted cross-section:</b> ≤ 0.75 mm<sup>2</sup></li></ul>	STE-1204-G	6009932

## SICK AT A GLANCE

SICK is one of the leading manufacturers of intelligent sensors and sensor solutions for industrial applications. A unique range of products and services creates the perfect basis for controlling processes securely and efficiently, protecting individuals from accidents and preventing damage to the environment.

We have extensive experience in a wide range of industries and understand their processes and requirements. With intelligent sensors, we can deliver exactly what our customers need. In application centers in Europe, Asia and North America, system solutions are tested and optimized in accordance with customer specifications. All this makes us a reliable supplier and development partner.

Comprehensive services complete our offering: SICK LifeTime Services provide support throughout the machine life cycle and ensure safety and productivity.

For us, that is “Sensor Intelligence.”

## WORLDWIDE PRESENCE:

Contacts and other locations –[www.sick.com](http://www.sick.com)