



# GSE2FS-E1111

G2

MINIATURE PHOTOELECTRIC SENSORS

**SICK**  
Sensor Intelligence.



### Ordering information

Type	Part no.
GSE2FS-E1111	1095469

Other models and accessories → [www.sick.com/G2](http://www.sick.com/G2)

Illustration may differ



### Detailed technical data

#### Features

<b>Functional principle</b>	Through-beam photoelectric sensor
<b>Dimensions (W x H x D)</b>	4.5 mm x 21 mm x 11 mm
<b>Housing design (light emission)</b>	Rectangular
<b>Minimum detectable object (MDO)</b>	0.2 mm
<b>Sensing range max.</b>	0 mm ... 60 mm
<b>Sensing range</b>	0 mm ... 40 mm
<b>Type of light</b>	Visible red light
<b>Light source</b>	PinPoint LED <sup>1)</sup>
<b>Light spot size (distance)</b>	Ø 4 mm (40 mm)
<b>Wave length</b>	660 nm
<b>Adjustment</b>	None

<sup>1)</sup> Average service life: 100,000 h at T<sub>J</sub> = +25 °C.

#### Mechanics/electronics

<b>Supply voltage U<sub>B</sub></b>	10 V DC ... 30 V DC
<b>Ripple</b>	< 5 V <sub>pp</sub> <sup>1)</sup>
<b>Current consumption</b>	20 mA <sup>2)</sup>

<sup>1)</sup> May not fall below or exceed U<sub>y</sub> tolerances.

<sup>2)</sup> Without load.

<sup>3)</sup> Signal transit time with resistive load.

<sup>4)</sup> With light/dark ratio 1:1.

<sup>5)</sup> Do not bend below 0 °C.

<sup>6)</sup> A = V<sub>S</sub> connections reverse-polarity protected.

<sup>7)</sup> C = interference suppression.

<sup>8)</sup> D = outputs overcurrent and short-circuit protected.

<b>Switching output</b>	NPN
<b>Switching mode</b>	Dark switching
<b>Output current I<sub>max.</sub></b>	≤ 50 mA
<b>Response time</b>	< 0.625 ms <sup>3)</sup>
<b>Switching frequency</b>	800 Hz <sup>4)</sup>
<b>Connection type</b>	Cable, 3-wire, 2 m <sup>5)</sup>
<b>Cable material</b>	Plastic, PVC
<b>Cable diameter</b>	Ø 2.3 mm
<b>Circuit protection</b>	A <sup>6)</sup> C <sup>7)</sup> D <sup>8)</sup>
<b>Weight</b>	40 g
<b>Housing material</b>	Plastic, VISTAL®
<b>Optics material</b>	Plastic, MABS
<b>Enclosure rating</b>	IP67
<b>Ambient operating temperature</b>	-20 °C ... +50 °C
<b>Ambient temperature, storage</b>	-40 °C ... +70 °C
<b>UL File No.</b>	NRKH.E348498 & NRKH7.E348498
<b>Repeatability (T<sub>a</sub> not constant)</b>	0.1 mm

1) May not fall below or exceed U<sub>y</sub> tolerances.

2) Without load.

3) Signal transit time with resistive load.

4) With light/dark ratio 1:1.

5) Do not bend below 0 °C.

6) A = V<sub>S</sub> connections reverse-polarity protected.

7) C = interference suppression.

8) D = outputs overcurrent and short-circuit protected.

## Classifications

<b>ECLASS 5.0</b>	27270901
<b>ECLASS 5.1.4</b>	27270901
<b>ECLASS 6.0</b>	27270901
<b>ECLASS 6.2</b>	27270901
<b>ECLASS 7.0</b>	27270901
<b>ECLASS 8.0</b>	27270901
<b>ECLASS 8.1</b>	27270901
<b>ECLASS 9.0</b>	27270901
<b>ECLASS 10.0</b>	27270901
<b>ECLASS 11.0</b>	27270901
<b>ECLASS 12.0</b>	27270901
<b>ETIM 5.0</b>	EC002716
<b>ETIM 6.0</b>	EC002716
<b>ETIM 7.0</b>	EC002716
<b>ETIM 8.0</b>	EC002716

UNSPSC 16.0901

39121528

### Connection diagram

Cd-049

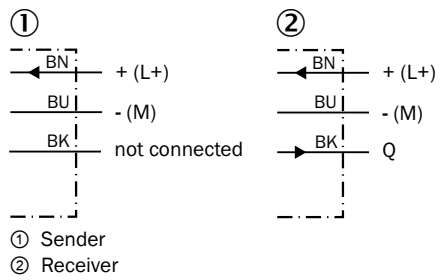

### Characteristic curve

Operating reserve

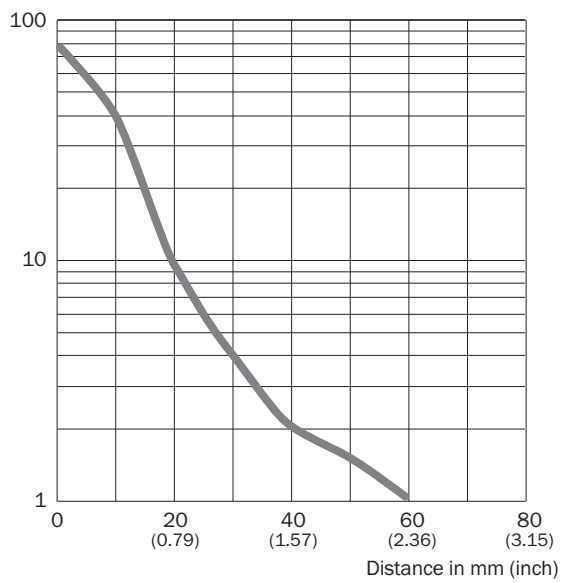

### Light spot size

GSE2 Flat Side, 50 mm

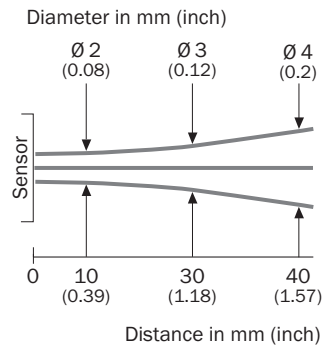

### Sensing range diagram

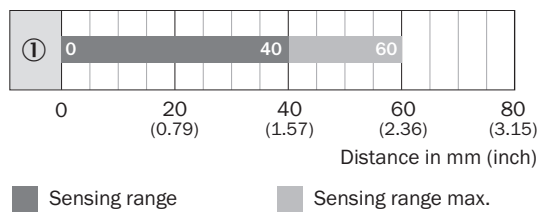

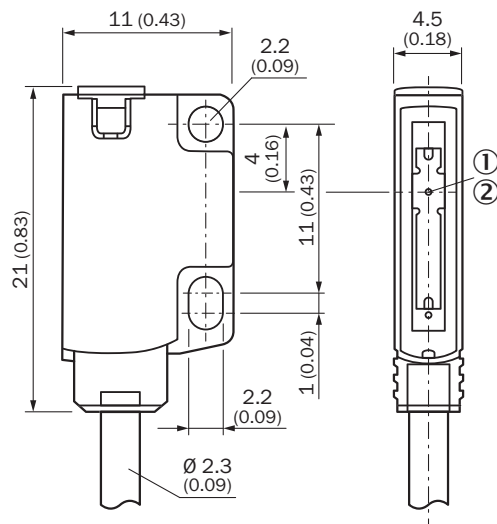

### Dimensional drawing (Dimensions in mm (inch))



- ① Optical axis, receiver
- ② Optical axis, sender

### Recommended accessories

Other models and accessories → [www.sick.com/G2](http://www.sick.com/G2)

	Brief description	Type	Part no.
Mounting brackets and plates			
	10 pieces, Mounting plate for direct mounting, from the rear, on wall or machine, not adjustable. 10 Piece,Black ,Plastic, VISTAL®. Suitable for GSE2FS only	BEF-G2F-SIDE-SPACER-M2	2107264
Others			
	<ul style="list-style-type: none"> <li>• <b>Connection type head A:</b> Male connector, M8, 3-pin, straight, A-coded</li> <li>• <b>Description:</b> Unshielded</li> <li>• <b>Connection systems:</b> Screw-type terminals</li> <li>• <b>Permitted cross-section:</b> 0.14 mm<sup>2</sup> ... 0.5 mm<sup>2</sup></li> </ul>	STE-0803-G	6037322

## SICK AT A GLANCE

SICK is one of the leading manufacturers of intelligent sensors and sensor solutions for industrial applications. A unique range of products and services creates the perfect basis for controlling processes securely and efficiently, protecting individuals from accidents and preventing damage to the environment.

We have extensive experience in a wide range of industries and understand their processes and requirements. With intelligent sensors, we can deliver exactly what our customers need. In application centers in Europe, Asia and North America, system solutions are tested and optimized in accordance with customer specifications. All this makes us a reliable supplier and development partner.

Comprehensive services complete our offering: SICK LifeTime Services provide support throughout the machine life cycle and ensure safety and productivity.

For us, that is “Sensor Intelligence.”

## WORLDWIDE PRESENCE:

Contacts and other locations –[www.sick.com](http://www.sick.com)