



GSE2FS-F5111

G2

MINIATURE PHOTOELECTRIC SENSORS

SICK
Sensor Intelligence.



Ordering information

Type	Part no.
GSE2FS-F5111	1095478

Other models and accessories → www.sick.com/G2

Illustration may differ



Detailed technical data

Features

Functional principle	Through-beam photoelectric sensor
Dimensions (W x H x D)	4.5 mm x 21 mm x 11 mm
Housing design (light emission)	Rectangular
Minimum detectable object (MDO)	0.2 mm
Sensing range max.	0 mm ... 60 mm
Sensing range	0 mm ... 40 mm
Type of light	Visible red light
Light source	PinPoint LED ¹⁾
Light spot size (distance)	Ø 4 mm (40 mm)
Wave length	660 nm
Adjustment	None

¹⁾ Average service life: 100,000 h at T_J = +25 °C.

Mechanics/electronics

Supply voltage U_B	10 V DC ... 30 V DC
Ripple	< 5 V _{pp} ¹⁾
Current consumption	20 mA ²⁾

¹⁾ May not fall below or exceed U_y tolerances.

²⁾ Without load.

³⁾ Signal transit time with resistive load.

⁴⁾ With light/dark ratio 1:1.

⁵⁾ Do not bend below 0 °C.

⁶⁾ A = V_S connections reverse-polarity protected.

⁷⁾ C = interference suppression.

⁸⁾ D = outputs overcurrent and short-circuit protected.

Switching output	PNP
Switching mode	Dark switching
Output current I_{\max}	≤ 50 mA
Response time	< 0.625 ms ³⁾
Switching frequency	800 Hz ⁴⁾
Connection type	Cable with connector M8, 3-pin, 200 mm ⁵⁾
Cable material	Plastic, PVC
Cable diameter	$\varnothing 2.3$ mm
Circuit protection	A ⁶⁾ C ⁷⁾ D ⁸⁾
Weight	23 g
Housing material	Plastic, VISTAL®
Optics material	Plastic, MABS
Enclosure rating	IP67
Ambient operating temperature	-20 °C ... +50 °C
Ambient temperature, storage	-40 °C ... +70 °C
UL File No.	NRKH.E348498 & NRKH7.E348498
Repeatability (T_a not constant)	0.1 mm

1) May not fall below or exceed U_y tolerances.

2) Without load.

3) Signal transit time with resistive load.

4) With light/dark ratio 1:1.

5) Do not bend below 0 °C.

6) A = V_S connections reverse-polarity protected.

7) C = interference suppression.

8) D = outputs overcurrent and short-circuit protected.

Classifications

ECLASS 5.0	27270901
ECLASS 5.1.4	27270901
ECLASS 6.0	27270901
ECLASS 6.2	27270901
ECLASS 7.0	27270901
ECLASS 8.0	27270901
ECLASS 8.1	27270901
ECLASS 9.0	27270901
ECLASS 10.0	27270901
ECLASS 11.0	27270901
ECLASS 12.0	27270901
ETIM 5.0	EC002716
ETIM 6.0	EC002716
ETIM 7.0	EC002716
ETIM 8.0	EC002716

UNSPSC 16.0901

39121528

Connection diagram

Cd-051

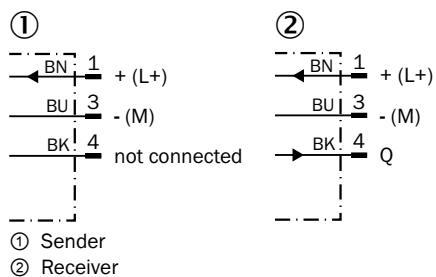

Characteristic curve

Operating reserve

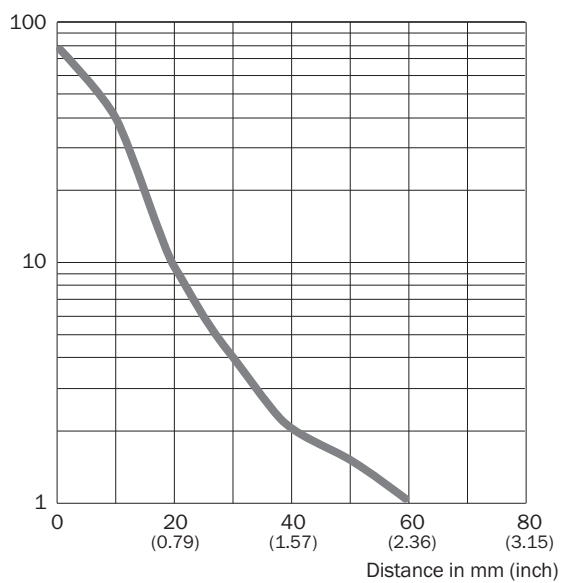

Light spot size

GSE2 Flat Side, 50 mm

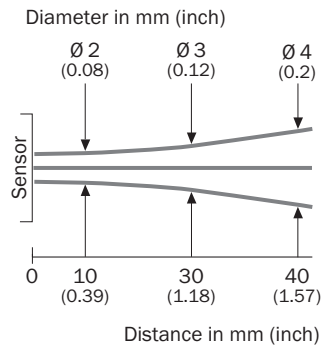

Sensing range diagram

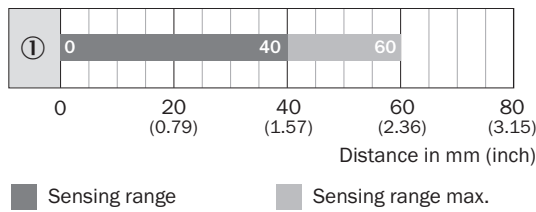

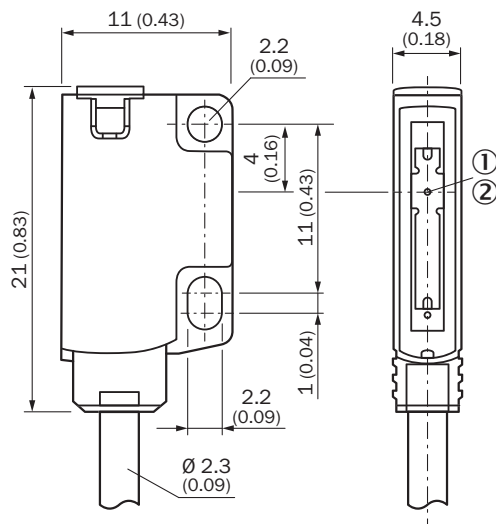

Dimensional drawing (Dimensions in mm (inch))



- ① Optical axis, receiver
- ② Optical axis, sender

Recommended accessories

Other models and accessories → www.sick.com/G2

	Brief description	Type	Part no.
Mounting brackets and plates			
	10 pieces, Mounting plate for direct mounting, from the rear, on wall or machine, not adjustable. 10 Piece,Black ,Plastic, VISTAL®. Suitable for GSE2FS only	BEF-G2F-SIDE-SPACER-M2	2107264
Others			
	<ul style="list-style-type: none"> • Connection type head A: Female connector, M8, 3-pin, straight, A-coded • Connection type head B: Flying leads • Signal type: Sensor/actuator cable • Cable: 5 m, 3-wire, PVC • Description: Sensor/actuator cable, unshielded • Application: Zones with chemicals 	YF8U13-050VA1XLEAX	2095884
	<ul style="list-style-type: none"> • Connection type head A: Male connector, M8, 3-pin, straight, A-coded • Description: Unshielded • Connection systems: Screw-type terminals • Permitted cross-section: 0.14 mm² ... 0.5 mm² 	STE-0803-G	6037322

SICK AT A GLANCE

SICK is one of the leading manufacturers of intelligent sensors and sensor solutions for industrial applications. A unique range of products and services creates the perfect basis for controlling processes securely and efficiently, protecting individuals from accidents and preventing damage to the environment.

We have extensive experience in a wide range of industries and understand their processes and requirements. With intelligent sensors, we can deliver exactly what our customers need. In application centers in Europe, Asia and North America, system solutions are tested and optimized in accordance with customer specifications. All this makes us a reliable supplier and development partner.

Comprehensive services complete our offering: SICK LifeTime Services provide support throughout the machine life cycle and ensure safety and productivity.

For us, that is “Sensor Intelligence.”

WORLDWIDE PRESENCE:

Contacts and other locations –www.sick.com