



GSE2S-F1311

G2

MINIATURE PHOTOELECTRIC SENSORS

SICK
Sensor Intelligence.



Illustration may differ



Ordering information

Type	Part no.
GSE2S-F1311	1064363

Other models and accessories → www.sick.com/G2

Detailed technical data

Features

Functional principle	Through-beam photoelectric sensor
Dimensions (W x H x D)	7.7 mm x 21.8 mm x 13.5 mm
Housing design (light emission)	Rectangular
Sensing range max.	0 m ... 2 m
Sensing range	0 m ... 1.5 m
Type of light	Visible red light
Light source	PinPoint LED ¹⁾
Light spot size (distance)	Ø 23 mm (500 mm)
Wave length	640 nm
Adjustment	None

¹⁾ Average service life: 100,000 h at T_J = +25 °C.

Mechanics/electronics

Supply voltage U_B	10 V DC ... 30 V DC ¹⁾
Ripple	< 5 V _{pp} ²⁾
Current consumption	20 mA ³⁾
Switching output	PNP

¹⁾ Limit values when operated in short-circuit protected network: max. 8 A.

²⁾ May not fall below or exceed U_V tolerances.

³⁾ Without load.

⁴⁾ Signal transit time with resistive load.

⁵⁾ With light/dark ratio 1:1.

⁶⁾ Do not bend below 0 °C.

⁷⁾ A = V_S connections reverse-polarity protected.

⁸⁾ C = interference suppression.

⁹⁾ D = outputs overcurrent and short-circuit protected.

Switching mode	Dark switching
Output current I_{\max}	≤ 50 mA
Response time	< 0.6 ms ⁴⁾
Switching frequency	800 Hz ⁵⁾
Connection type	Cable, 3-wire, 2 m ⁶⁾
Cable material	Plastic, PVC
Cable diameter	$\varnothing 3$ mm
Circuit protection	A ⁷⁾ C ⁸⁾ D ⁹⁾
Weight	72.2 g
Housing material	Plastic, ABS
Optics material	Plastic, PMMA
Enclosure rating	IP67
Ambient operating temperature	-25 °C ... $+50$ °C
Ambient temperature, storage	-40 °C ... $+75$ °C
UL File No.	NRKH.E181493

1) Limit values when operated in short-circuit protected network: max. 8 A.

2) May not fall below or exceed U_y tolerances.

3) Without load.

4) Signal transit time with resistive load.

5) With light/dark ratio 1:1.

6) Do not bend below 0 °C.

7) A = V_S connections reverse-polarity protected.

8) C = interference suppression.

9) D = outputs overcurrent and short-circuit protected.

Safety-related parameters

MTTF_D	2,659 years
DC_{avg}	0 %

Classifications

ECLASS 5.0	27270901
ECLASS 5.1.4	27270901
ECLASS 6.0	27270901
ECLASS 6.2	27270901
ECLASS 7.0	27270901
ECLASS 8.0	27270901
ECLASS 8.1	27270901
ECLASS 9.0	27270901
ECLASS 10.0	27270901
ECLASS 11.0	27270901
ECLASS 12.0	27270901
ETIM 5.0	EC002716
ETIM 6.0	EC002716

ETIM 7.0	EC002716
ETIM 8.0	EC002716
UNSPSC 16.0901	39121528

Connection type

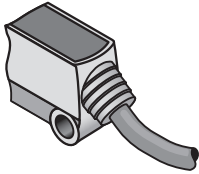

Connection diagram

Cd-049

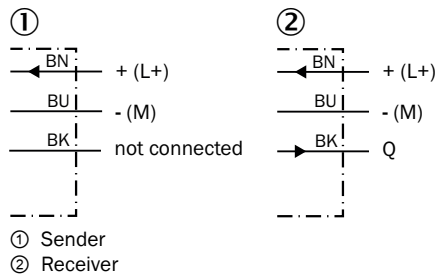

Characteristic curve

GSE2S

Functional reserve

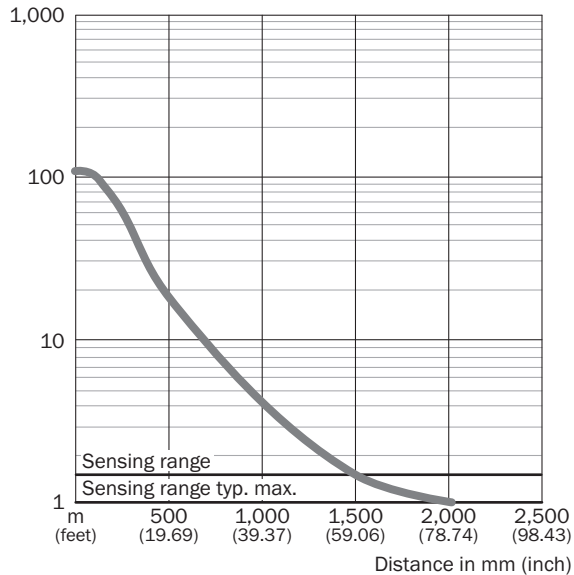

Light spot size

GSE2S

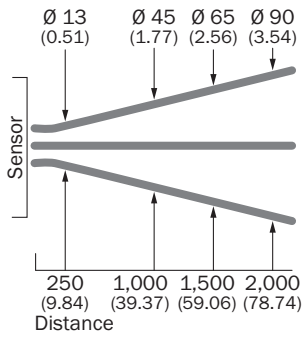

Sensing range diagram

GSE2S

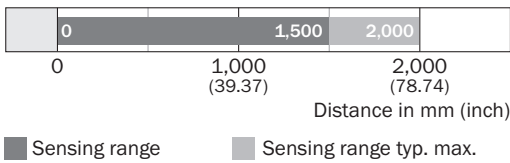

Dimensional drawing (Dimensions in mm (inch))

GSE2S

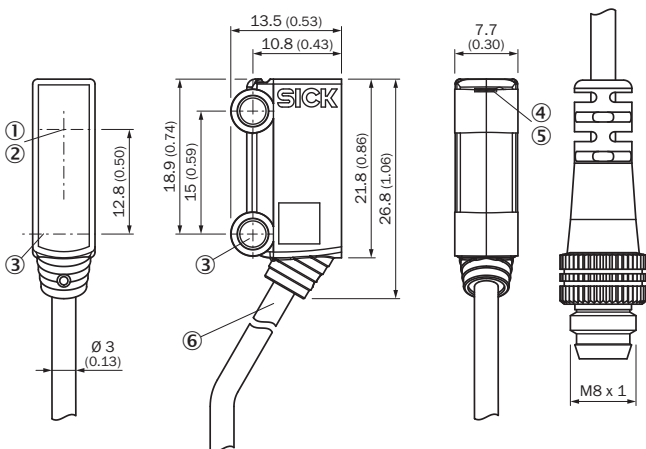

- ① Optical axis, receiver
- ② Optical axis, sender
- ③ Mounting hole, Ø 3.2 mm
- ④ LED indicator green: Supply voltage active
- ⑤ LED indicator yellow: Status of received light beam
- ⑥ Connection

Recommended accessories

Other models and accessories → www.sick.com/G2

	Brief description	Type	Part no.
Others			
	<ul style="list-style-type: none">• Connection type head A: Male connector, M8, 3-pin, straight, A-coded• Description: Unshielded• Connection systems: Screw-type terminals• Permitted cross-section: 0.14 mm² ... 0.5 mm²	STE-0803-G	6037322

SICK AT A GLANCE

SICK is one of the leading manufacturers of intelligent sensors and sensor solutions for industrial applications. A unique range of products and services creates the perfect basis for controlling processes securely and efficiently, protecting individuals from accidents and preventing damage to the environment.

We have extensive experience in a wide range of industries and understand their processes and requirements. With intelligent sensors, we can deliver exactly what our customers need. In application centers in Europe, Asia and North America, system solutions are tested and optimized in accordance with customer specifications. All this makes us a reliable supplier and development partner.

Comprehensive services complete our offering: SICK LifeTime Services provide support throughout the machine life cycle and ensure safety and productivity.

For us, that is “Sensor Intelligence.”

WORLDWIDE PRESENCE:

Contacts and other locations –www.sick.com