



GTB20G-1IRC116GZZZ

G20

COMPACT PHOTOELECTRIC SENSORS

SICK
Sensor Intelligence.

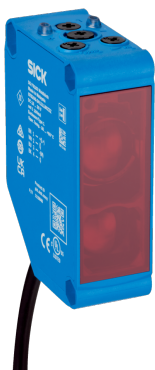

Illustration may differ



Ordering information

Type	Part no.
GTB20G-1IRC116GZZZ	1126448

Other models and accessories → www.sick.com/G20

Detailed technical data

Features

Functional principle	Photoelectric proximity sensor
Functional principle detail	Background suppression
Sensing range	
Sensing range min.	0.005 m
Sensing range max.	3 m
Adjustable switching threshold for background suppression	0.1 m ... 3 m
Reference object	Object with 90% remission factor (complies with standard white according to DIN 5033)
Minimum distance between set sensing range and background (black 6% / white 90%)	200 mm, at a distance of 1000 mm
Emitted beam	
Light source	LED
Type of light	Visible red light
Shape of light spot	Rectangular
Light spot size (distance)	Ø 28 mm (500 mm)
Maximum dispersion of the emitted beam around the standardized transmission axis (squint angle)	< +/- 1.5° (at T _a = +23 °C)
Key LED figures	
Normative reference	EN 62471:2008-09 IEC 62471:2006, modified
LED risk group marking	Free group
Wave length	630 nm
Average service life	100,000 h at T _a = +25 °C
Adjustment	
Potentiometer 1	For setting the sensing range, 7 rotations
Operating mode switch	For inverting the switching function (light/dark switching)

	Potentiometer 2	For adjusting the delay time
	Potentiometer 3	For selecting the delay time
Indication	LED green	Operating indicator Static on: power on Static off: object not present
	LED yellow	Status of received light beam Static on: object present Static off: object not present

Electrical data

Supply voltage U_e	24 V AC/DC ... 240 V AC/DC ¹⁾	
Ripple	< 10 %	
Usage category	DC-13 (according to EN 60947-1) AC-15 (according to EN 60947-1)	
Current consumption	≤ 10 mA, ≤ 45 mA, Without load At 230 V AC/DC, Without load At 24 V AC/DC	
Protection class	II	
Digital output	Number	2 (Complementary)
	Type	Relay, SPDT, electrically isolated ²⁾
	Switching mode	Light/dark switching
	Output current I _{max}	4 A@250 V AC, 4 A@24 VDC, 0.11 A@250 V DCUL: 4 A@250 V AC, general use4 A @ 250 V AC, resistive (NO)3 A @ 250 V AC, resistive (NC)4 A @ 24 V DC, NO, general use3 A @ 24 V DC, NC, general useR300/B300 (NO contacts only)
	Response time	≤ 15 ms
	Switching frequency	10 Hz ³⁾
	Time functions	Deactivated (factory setting), switch-on delay, off delay, ON and OFF delay
	Delay time	Adjustable via time delay selector switch, 0 ms ... 10,000 ms, 0 ms (factory setting)
Pin/Wire assignment	BN	L/(+)
	BU	N/(-)
	WH	Relay COM
	BK	Relay NO Relay output, light switching, object present → output HIGH
	GY	Relay NC Relay output, dark switching, object present → output LOW

¹⁾ +- 10 %.

²⁾ Valid only for devices manufactured before June 18, 2023 with a date code of 2324 or earlier. Suitable arc suppression with inductive or capacitive load. Relay contacts are separated from the supply voltage by a base insulation of 3.2 mm. Depending on the application, additional insulation may be required in the user wiring.

³⁾ With light/dark ratio 1:1.

Mechanical data

Housing	Rectangular	
Dimensions (W x H x D)	23.5 mm x 74.5 mm x 63 mm	
Connection	Cable, 5-wire, 2 m	
Connection detail	Deep-freeze property	Do not bend below 0 °C
	Conductor size	0.32 mm ²

Cable diameter	Ø 5 mm
Length of cable (L)	2 m
Material	
Housing	Plastic, ABS
Front screen	Plastic, PMMA
Cable	Plastic, PVC
Weight	Approx. 155 g

Ambient data

Enclosure rating	IP67 (EN 60529)
Ambient operating temperature	-30 °C ... +60 °C ¹⁾
Ambient temperature, storage	-40 °C ... +70 °C
Typ. Ambient light immunity	Sunlight: ≤ 20,000 lx
Shock resistance	30 g, 11 ms (3 positive and 3 negative shocks along X, Y, Z axes, 18 total shocks (EN60068-2-27))
Vibration resistance	10 Hz ... 1,000 Hz (Amplitude 1 mm, 3 x 30 min (EN60068-2-6))
Air humidity	35 % ... 95 %, relative humidity (no condensation)
Electromagnetic compatibility (EMC)	EN 60947-5-2, EN 61000-6-3
UL File No.	NRKH.E348498 & NRKH7.E348498

¹⁾ The max. ambient temperature is 50 °C (UL).

Classifications

ECLASS 5.0	27270904
ECLASS 5.1.4	27270904
ECLASS 6.0	27270904
ECLASS 6.2	27270904
ECLASS 7.0	27270904
ECLASS 8.0	27270904
ECLASS 8.1	27270904
ECLASS 9.0	27270904
ECLASS 10.0	27270904
ECLASS 11.0	27270904
ECLASS 12.0	27270903
ETIM 5.0	EC002719
ETIM 6.0	EC002719
ETIM 7.0	EC002719
ETIM 8.0	EC002719
UNSPSC 16.0901	39121528

Adjustments

Display and adjustment elements

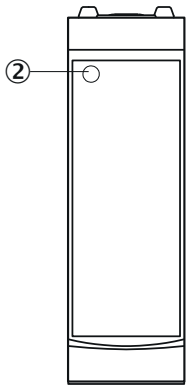

② LED yellow

Display and adjustment elements

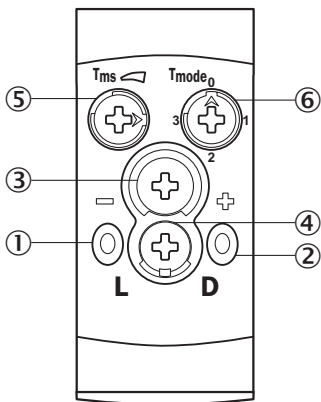

- ① LED green
- ② LED yellow
- ③ Potentiometer 1
- ④ Operating mode switch
- ⑤ Potentiometer 2
- ⑥ Potentiometer 3

Connection type

Cable, 5-wire

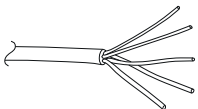

Connection diagram

Cd-163

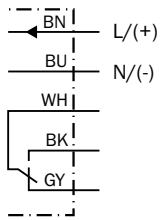

Characteristic curve

Minimum distance in mm (y) between the set sensing range (x) and white background (90 % remission)

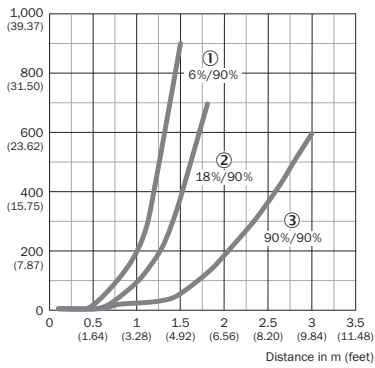

Example:
 Safe suppression of the background

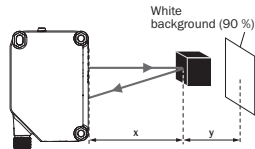

Black object (6 % remission)
 Set sensing range $x = 1.0$ m
 Needed minimum distance to white background $y = 200$ mm

- ① Black object, 6% remission factor
- ② Gray object, 18% remission factor
- ③ White object, 90% remission factor

Light spot size

Dimensions in mm (inch)

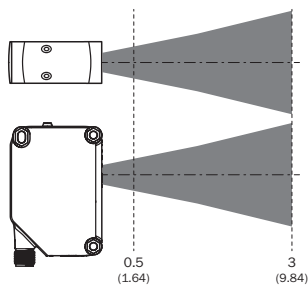
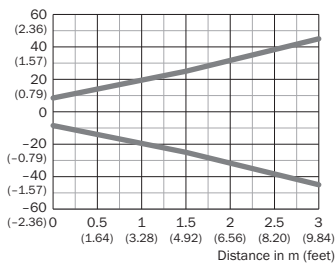

Sensing range diagram

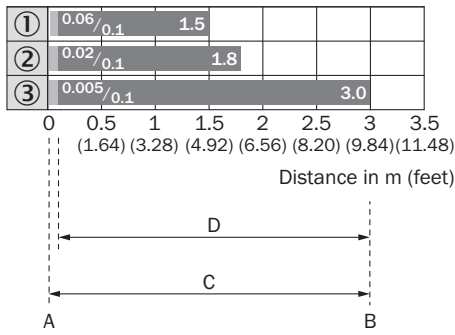

1	Black object, 6% remission factor
2	Gray object, 18% remission factor
3	White object, 90% remission factor
A	Sensing range min. in m
B	Sensing range max. in m
C	Field of view
D	Adjustable switching threshold for background suppression

Dimensional drawing (Dimensions in mm (inch))

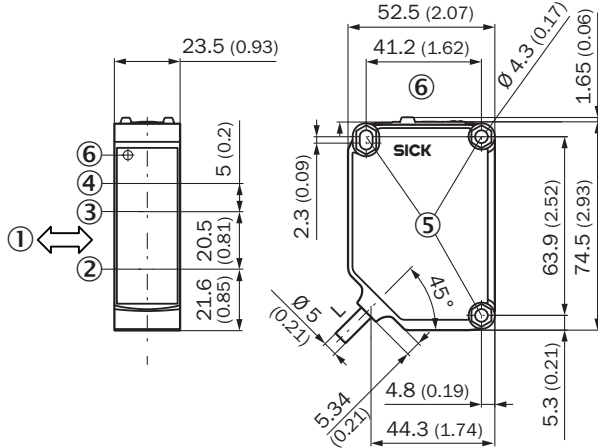



For length of cable (L), see technical data

- ① Standard direction of the material being detected
- ② Center of optical axis, sender
- ③ Center of optical axis, receiver (close range)
- ④ Center of optical axis, receiver (far range)
- ⑤ Fixing hole \varnothing 4.3 mm, both sides for hexagon nut M4
- ⑥ Display and adjustment elements

Recommended accessories

Other models and accessories → www.sick.com/G20

	Brief description	Type	Part no.
Mounting brackets and plates			
	Mounting bracket, Stainless steel V2A (1.4301), 2 screws, 2 nuts, 2 circlips, 2 washers for mounting the sensor	BEF-W280	5313885
Others			
	<ul style="list-style-type: none"> • Connection type head A: Male connector, M12, 5-pin, straight, A-coded • Description: Unshielded, Head A: male connector, M12, 5-pin, straight, unshielded, for cable diameter 4 mm ... 6 mm Head B: - • Connection systems: Screw-type terminals • Permitted cross-section: ≤ 0.75 mm² • Note: For field bus technology 	STE-1205-G	6022083

SICK AT A GLANCE

SICK is one of the leading manufacturers of intelligent sensors and sensor solutions for industrial applications. A unique range of products and services creates the perfect basis for controlling processes securely and efficiently, protecting individuals from accidents and preventing damage to the environment.

We have extensive experience in a wide range of industries and understand their processes and requirements. With intelligent sensors, we can deliver exactly what our customers need. In application centers in Europe, Asia and North America, system solutions are tested and optimized in accordance with customer specifications. All this makes us a reliable supplier and development partner.

Comprehensive services complete our offering: SICK LifeTime Services provide support throughout the machine life cycle and ensure safety and productivity.

For us, that is “Sensor Intelligence.”

WORLDWIDE PRESENCE:

Contacts and other locations –www.sick.com