



# GTB20M-1IM1160ZZZ

G20

COMPACT PHOTOELECTRIC SENSORS

**SICK**  
Sensor Intelligence.

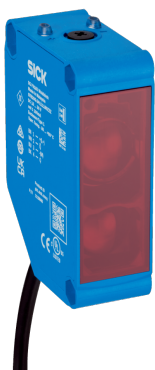

Illustration may differ



## Ordering information

Type	Part no.
GTB20M-1IM11160ZZZ	1120699

Other models and accessories → [www.sick.com/G20](http://www.sick.com/G20)

## Detailed technical data

### Features

<b>Functional principle</b>	Photoelectric proximity sensor
<b>Functional principle detail</b>	Background suppression
<b>Sensing range</b>	
Sensing range min.	0.005 m
Sensing range max.	3 m
Adjustable switching threshold for background suppression	0.1 m ... 3 m
Reference object	Object with 90% remission factor (complies with standard white according to DIN 5033)
Minimum distance between set sensing range and background (black 6% / white 90%)	200 mm, at a distance of 1000 mm
<b>Emitted beam</b>	
Light source	LED
Type of light	Infrared light
Shape of light spot	Rectangular
Light spot size (distance)	Ø 28 mm (500 mm)
Maximum dispersion of the emitted beam around the standardized transmission axis (squint angle)	< +/- 1.5° (at T <sub>a</sub> = +23 °C)
<b>Key LED figures</b>	
Normative reference	EN 62471:2008-09   IEC 62471:2006, modified
LED risk group marking	Free group
Wave length	850 nm
Average service life	100,000 h at T <sub>a</sub> = +25 °C
<b>Adjustment</b>	
Potentiometer	For setting the sensing range, 7 rotations
<b>Indication</b>	

LED green	Operating indicator Static on: power on Static off: object not present
LED yellow	Status of received light beam Static on: object present

### Safety-related parameters

<b>MTTF<sub>D</sub></b>	539 years
<b>DC<sub>avg</sub></b>	0%

### Electrical data

<b>Supply voltage U<sub>B</sub></b>	10 V DC ... 30 V DC <sup>1)</sup>
<b>Ripple</b>	< 5 V <sub>pp</sub>
<b>Usage category</b>	According to EN 60947-1
<b>Current consumption</b>	≤ 50 mA, without load. At U <sub>B</sub> = 24 V
<b>Protection class</b>	III
<b>Digital output</b>	
Number	2 (Complementary)
Type	Solid state relay
Switching mode	Light/dark switching
Output current I <sub>max</sub>	≤ 100 mA <sup>2)</sup>
Response time	≤ 1.67 ms
Switching frequency	300 Hz <sup>3)</sup>
<b>Pin/Wire assignment</b>	
BN	+ (L+)
WH	Relay NC Relay output, dark switching, object present → output LOW
BU	- (M)
BK	Relay NO Relay output, light switching, object present → output HIGH
GY	Relay COM

<sup>1)</sup> Limit values.

<sup>2)</sup> At U<sub>B</sub> > 24 V, I<sub>max</sub> = 100 mA.

<sup>3)</sup> With light/dark ratio 1:1.

### Mechanical data

<b>Housing</b>	Rectangular
<b>Dimensions (W x H x D)</b>	23.5 mm x 74.5 mm x 52.5 mm
<b>Connection</b>	Cable, 5-wire, 2 m
<b>Connection detail</b>	
Deep-freeze property	Do not bend below 0 °C
Conductor size	0.32 mm <sup>2</sup>
Cable diameter	Ø 5 mm
Length of cable (L)	2 m
<b>Material</b>	
Housing	Plastic, ABS

	Front screen	Plastic, PMMA
	Cable	Plastic, PVC
<b>Weight</b>		Approx. 120 g

Ambient data

<b>Enclosure rating</b>	IP67 (EN 60529)
<b>Ambient operating temperature</b>	-30 °C ... +60 °C
<b>Ambient temperature, storage</b>	-40 °C ... +70 °C
<b>Typ. Ambient light immunity</b>	Sunlight: ≤ 20,000 lx
<b>Shock resistance</b>	30 g, 11 ms (3 positive and 3 negative shocks along X, Y, Z axes, 18 total shocks (EN60068-2-27))
<b>Vibration resistance</b>	10 Hz ... 1,000 Hz (Amplitude 1 mm, 3 x 30 min (EN60068-2-6))
<b>Air humidity</b>	35 % ... 95 %, relative humidity (no condensation)
<b>Electromagnetic compatibility (EMC)</b>	EN 60947-5-2
<b>UL File No.</b>	NRKH.E348498 & NRKH7.E348498

Classifications

<b>ECLASS 5.0</b>	27270904
<b>ECLASS 5.1.4</b>	27270904
<b>ECLASS 6.0</b>	27270904
<b>ECLASS 6.2</b>	27270904
<b>ECLASS 7.0</b>	27270904
<b>ECLASS 8.0</b>	27270904
<b>ECLASS 8.1</b>	27270904
<b>ECLASS 9.0</b>	27270904
<b>ECLASS 10.0</b>	27270904
<b>ECLASS 11.0</b>	27270904
<b>ECLASS 12.0</b>	27270903
<b>ETIM 5.0</b>	EC002719
<b>ETIM 6.0</b>	EC002719
<b>ETIM 7.0</b>	EC002719
<b>ETIM 8.0</b>	EC002719
<b>UNSPSC 16.0901</b>	39121528

## Adjustments

Display and adjustment elements

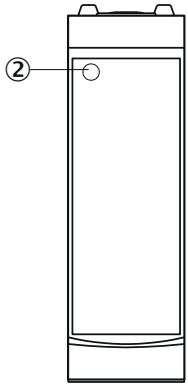

② LED yellow

Display and adjustment elements

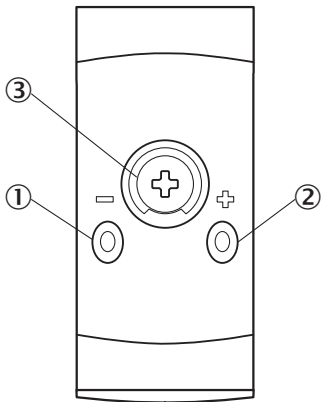

- ① LED green
- ② LED yellow
- ③ Potentiometer

## Connection type

Cable, 5-wire

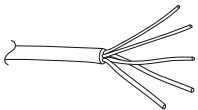

### Connection diagram

Cd-581

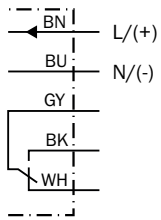

### Characteristic curve

Minimum distance in mm (y) between the set sensing range (x) and white background (90 % remission)

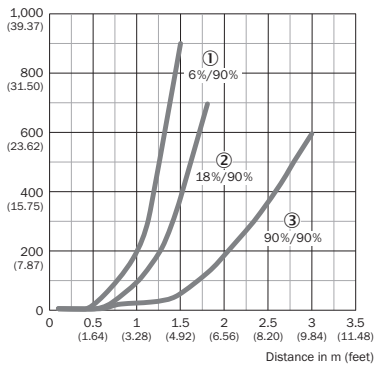

Example:  
 Safe suppression of the background

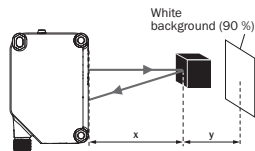

Black object (6 % remission)  
 Set sensing range  $x = 1.0$  m  
 Needed minimum distance to white background  $y = 200$  mm

- ① Black object, 6% remission factor
- ② Gray object, 18% remission factor
- ③ White object, 90% remission factor

### Light spot size

Dimensions in mm (inch)

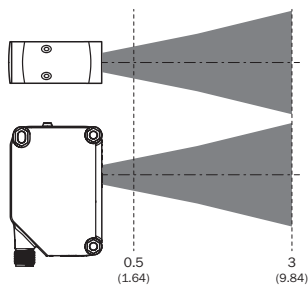
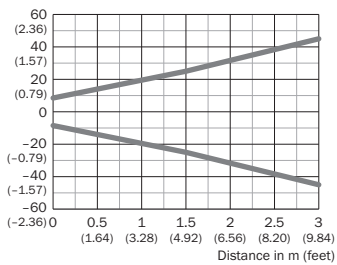

### Sensing range diagram

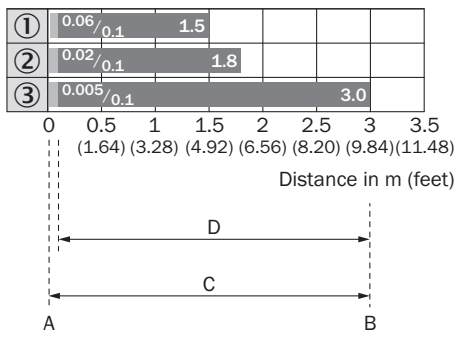

1	Black object, 6% remission factor
2	Gray object, 18% remission factor
3	White object, 90% remission factor
A	Sensing range min. in m
B	Sensing range max. in m
C	Field of view
D	Adjustable switching threshold for background suppression

### Dimensional drawing (Dimensions in mm (inch))

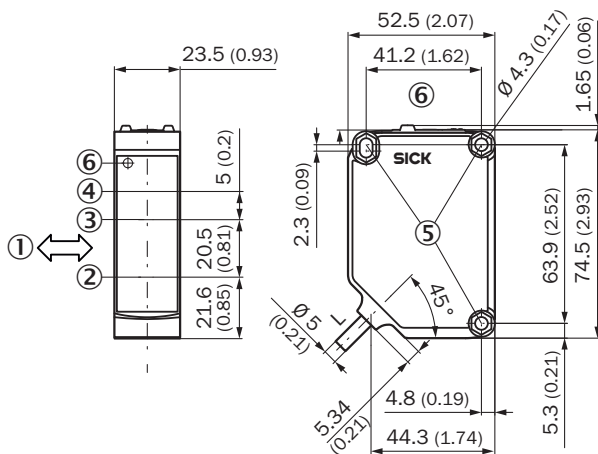



For length of cable (L), see technical data

- ① Standard direction of the material being detected
- ② Center of optical axis, sender
- ③ Center of optical axis, receiver (close range)
- ④ Center of optical axis, receiver (far range)
- ⑤ Fixing hole  $\varnothing$  4.3 mm, both sides for hexagon nut M4
- ⑥ Display and adjustment elements

Recommended accessories

Other models and accessories → [www.sick.com/G20](http://www.sick.com/G20)

	Brief description	Type	Part no.
Mounting brackets and plates			
	Mounting bracket, Stainless steel V2A (1.4301), 2 screws, 2 nuts, 2 circlips, 2 washers for mounting the sensor	BEF-W280	5313885
Others			
	<ul style="list-style-type: none"> <li>• <b>Connection type head A:</b> Male connector, M12, 5-pin, straight, A-coded</li> <li>• <b>Description:</b> Unshielded, Head A: male connector, M12, 5-pin, straight, unshielded, for cable diameter 4 mm ... 6 mm Head B: -</li> <li>• <b>Connection systems:</b> Screw-type terminals</li> <li>• <b>Permitted cross-section:</b> ≤ 0.75 mm<sup>2</sup></li> <li>• <b>Note:</b> For field bus technology</li> </ul>	STE-1205-G	6022083



## SICK AT A GLANCE

SICK is one of the leading manufacturers of intelligent sensors and sensor solutions for industrial applications. A unique range of products and services creates the perfect basis for controlling processes securely and efficiently, protecting individuals from accidents and preventing damage to the environment.

We have extensive experience in a wide range of industries and understand their processes and requirements. With intelligent sensors, we can deliver exactly what our customers need. In application centers in Europe, Asia and North America, system solutions are tested and optimized in accordance with customer specifications. All this makes us a reliable supplier and development partner.

Comprehensive services complete our offering: SICK LifeTime Services provide support throughout the machine life cycle and ensure safety and productivity.

For us, that is “Sensor Intelligence.”

## WORLDWIDE PRESENCE:

Contacts and other locations –[www.sick.com](http://www.sick.com)