



# GTE10-R3811

G10

**SMALL PHOTOELECTRIC SENSORS**

**SICK**  
Sensor Intelligence.



### Ordering information

Type	Part no.
GTE10-R3811	1064688

Other models and accessories → [www.sick.com/G10](http://www.sick.com/G10)

Illustration may differ



### Detailed technical data

#### Features

<b>Functional principle</b>	Photoelectric proximity sensor
<b>Functional principle detail</b>	Energetic
<b>Dimensions (W x H x D)</b>	20 mm x 50 mm x 51.5 mm
<b>Housing design (light emission)</b>	Rectangular
<b>Sensing range max.</b>	20 mm ... 1,300 mm <sup>1)</sup>
<b>Sensing range</b>	40 mm ... 950 mm <sup>1)</sup>
<b>Type of light</b>	Visible red light
<b>Light source</b>	PinPoint LED <sup>2)</sup>
<b>Light spot size (distance)</b>	Ø 28 mm (1,400 mm)
<b>Wave length</b>	625 nm
<b>Adjustment</b>	Potentiometer, 270°

<sup>1)</sup> Object with 90% remission (based on standard white, DIN 5033).

<sup>2)</sup> Average service life: 100,000 h at T<sub>J</sub> = +25 °C.

## Mechanics/electronics

<b>Supply voltage <math>U_B</math></b>	24 V AC/DC ... 240 V AC/DC <sup>1)</sup>
<b>Ripple</b>	< 10 %
<b>Power consumption</b>	≤ 2.5 VA
<b>Switching output</b>	Relay, SPDT, electrically isolated <sup>2)</sup>
<b>Switching load max. (current/voltage)</b>	0.11 A (250 V DC) 3 A (30 V DC) 3 A (250 V AC)
<b>Response time</b>	≤ 10 ms
<b>Switching frequency</b>	20 Hz <sup>3)</sup>
<b>Connection type</b>	Cable, 5-wire, 2 m <sup>4)</sup>
<b>Cable material</b>	Plastic, PVC
<b>Conductor cross section</b>	0.25 mm <sup>2</sup>
<b>Circuit protection</b>	C <sup>5)</sup>
<b>Protection class</b>	II <sup>6)</sup>
<b>Weight</b>	115 g
<b>Interference emission</b>	EN 61000-6-3 (2011-09) <sup>7)</sup>
<b>Housing material</b>	Plastic, ABS/PMMA
<b>Enclosure rating</b>	IP67
<b>Relay switching cycles min.</b>	100.000 cycles (3 A)
<b>Electromagnetic compatibility (EMC)</b>	EN 60947-5-2 EN 61000-6-3 (2011-09)
<b>Ambient operating temperature</b>	-30 °C ... +60 °C <sup>8)</sup>
<b>Ambient temperature, storage</b>	-40 °C ... +70 °C
<b>UL File No.</b>	NRKH.E348498 & NRKH7.E348498
<b>More standards</b>	UL325 <sup>9)</sup>

<sup>1)</sup> +/- 10 %.

<sup>2)</sup> Provide suitable spark suppression for inductive or capacitive loads.

<sup>3)</sup> With light/dark ratio 1:1.

<sup>4)</sup> Do not bend below 0 °C.

<sup>5)</sup> C = interference suppression.

<sup>6)</sup> Reference voltage: 250 V AC.

<sup>7)</sup> In the case of a DC supply (ref. to EN 61000-6-3) the length of cable between the supply source and the sensor must be < 30 m.

<sup>8)</sup> UL: 0 °C ... +50 °C.

<sup>9)</sup> Complies with the UL325 standard when used with sturdy protection hood (e.g. BEF-G10WSG, 2071960).

## Classifications

<b>ECLASS 5.0</b>	27270903
<b>ECLASS 5.1.4</b>	27270903
<b>ECLASS 6.0</b>	27270903
<b>ECLASS 6.2</b>	27270903
<b>ECLASS 7.0</b>	27270903
<b>ECLASS 8.0</b>	27270903
<b>ECLASS 8.1</b>	27270903
<b>ECLASS 9.0</b>	27270903

<b>ECLASS 10.0</b>	27270904
<b>ECLASS 11.0</b>	27270904
<b>ECLASS 12.0</b>	27270903
<b>ETIM 5.0</b>	EC001821
<b>ETIM 6.0</b>	EC001821
<b>ETIM 7.0</b>	EC002719
<b>ETIM 8.0</b>	EC002719
<b>UNSPSC 16.0901</b>	39121528

### Adjustments

GTB10, GTE10, AC/DC

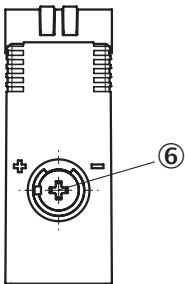

⑥ Adjustment of sensing range

### Connection diagram

Cd-163

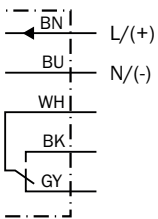

## Characteristic curve

Operating reserve

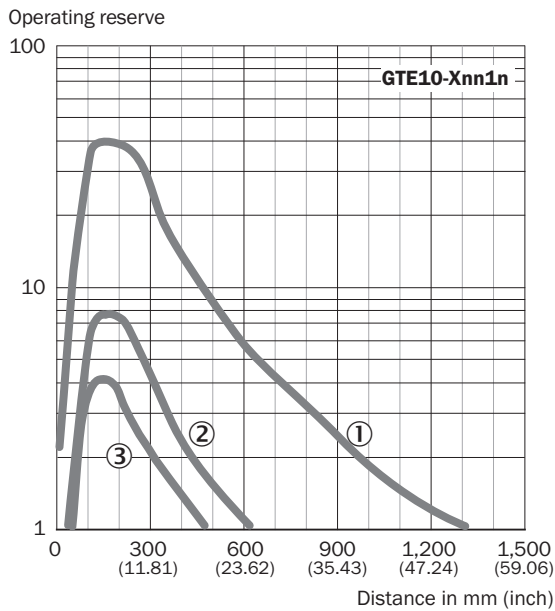

- ① Sensing range on white, 90% remission factor
- ② Sensing range on gray, 18% remission factor
- ③ Sensing range on black, 6% remission factor

## Light spot size

Light spot size

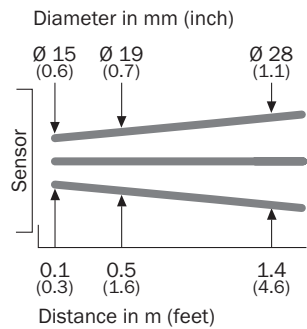

### Sensing range diagram

Scanning range

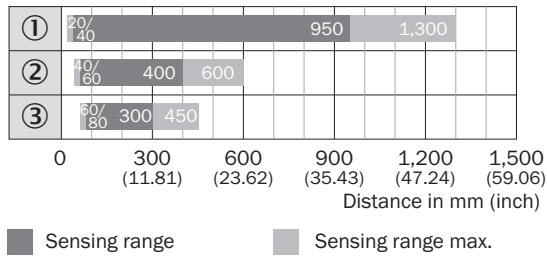

### Dimensional drawing (Dimensions in mm (inch))

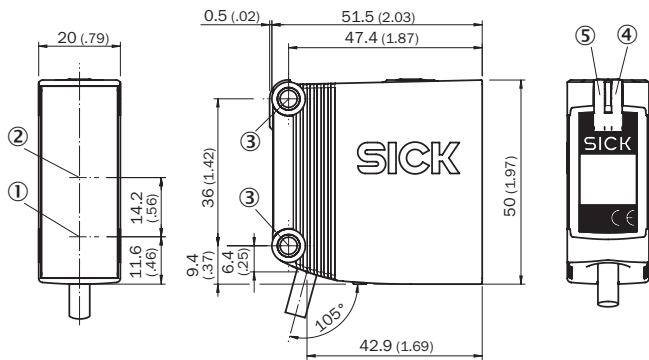

GTE10, GL10, GL10G, AC/DC, cable



- ① Center of optical axis, sender
- ② Center of optical axis, receiver
- ③ Mounting hole,  $\varnothing$  4.2 mm
- ④ LED indicator yellow: Status of received light beam
- ⑤ LED indicator green: power on

### Recommended accessories

Other models and accessories → [www.sick.com/G10](http://www.sick.com/G10)

	Brief description	Type	Part no.
Universal bar clamp systems			
	Q-Lock, bar clamp system for G10 and reflector P250, Die-cast zinc, steel, zinc coated	BEF-KHSQ12R01	2071260
Others			
	<ul style="list-style-type: none"> <li>• <b>Connection type head A:</b> Male connector, M12, 5-pin, straight, A-coded</li> <li>• <b>Description:</b> Unshielded, Head A: male connector, M12, 5-pin, straight, unshielded, for cable diameter 4 mm ... 6 mm Head B: -</li> <li>• <b>Connection systems:</b> Screw-type terminals</li> <li>• <b>Permitted cross-section:</b> <math>\leq 0.75 \text{ mm}^2</math></li> <li>• <b>Note:</b> For field bus technology</li> </ul>	STE-1205-G	6022083

## SICK AT A GLANCE

SICK is one of the leading manufacturers of intelligent sensors and sensor solutions for industrial applications. A unique range of products and services creates the perfect basis for controlling processes securely and efficiently, protecting individuals from accidents and preventing damage to the environment.

We have extensive experience in a wide range of industries and understand their processes and requirements. With intelligent sensors, we can deliver exactly what our customers need. In application centers in Europe, Asia and North America, system solutions are tested and optimized in accordance with customer specifications. All this makes us a reliable supplier and development partner.

Comprehensive services complete our offering: SICK LifeTime Services provide support throughout the machine life cycle and ensure safety and productivity.

For us, that is “Sensor Intelligence.”

## WORLDWIDE PRESENCE:

Contacts and other locations –[www.sick.com](http://www.sick.com)