



HL18-F3A3BD

H18 Sure Sense

HYBRID PHOTOELECTRIC SENSORS

SICK
Sensor Intelligence.

HL18-F3A3BD | H18 Sure Sense

HYBRID PHOTOELECTRIC SENSORS



Illustration may differ



Ordering information

| Type | Part no. |
|-------------|----------|
| HL18-F3A3BD | 1073695 |

Other models and accessories → www.sick.com/H18_Sure_Sense

Detailed technical data

Features

| | |
|----------------------------------------|-------------------------------------------------------|
| Functional principle | Photoelectric retro-reflective sensor |
| Functional principle detail | With minimum distance to reflector (dual lens system) |
| Dimensions (W x H x D) | 16.2 mm x 44.9 mm x 31.8 mm |
| Housing design (light emission) | Hybrid |
| Thread diameter (housing) | M18 |
| Mounting system type | M18, head/side (24.1 ... 25.4 mm) |
| Housing color | Blue |
| Sensing range max. | 0.03 m ... 6.5 m ¹⁾ |
| Sensing range | 0.03 m ... 5 m ¹⁾ |
| Type of light | Visible red light |
| Light source | PinPoint LED ²⁾ |
| Light spot size (distance) | 130 mm x 260 mm (6.5 m) |
| Wave length | 631 nm |
| Adjustment | |
| Potentiometer, right | Off delay, adjustable: 0 ... 2 s |
| Potentiometer, left | None |
| Special features | Signal strength light bar |

¹⁾ Reflector PL80A.

²⁾ Average service life: 100,000 h at T_J = +25 °C.

Mechanics/electronics

| | |
|--------------------------------------------|----------------------------------------------------------------------------------------------------------------------------------------------------------------------------------------------|
| Supply voltage | 10 V DC ... 30 V DC |
| Ripple | $< 5 V_{pp}$ ¹⁾ |
| Current consumption | $\leq 20 \text{ mA}$ ²⁾ |
| Switching output | Push-pull: PNP/NPN |
| Output function | Complementary |
| Switching mode | Light/dark switching |
| Switching output detail | |
| Switching output Q1 | Push-pull: PNP/NPN, Light switching ³⁾ |
| Switching output Q2 | Push-pull: PNP/NPN, Dark switching ³⁾ |
| Output current I_{max} | $\leq 100 \text{ mA}$ |
| Response time | $\leq 0.5 \text{ ms}$ ⁴⁾ |
| Switching frequency | 1,000 Hz ⁵⁾ |
| Time functions | Off delay |
| Connection type | Male connector M8, 4-pin |
| Circuit protection | A ⁶⁾ B ⁷⁾ D ⁸⁾ |
| Protection class | III |
| Weight | 18 g |
| Polarisation filter | ✓ |
| Housing material | Plastic, VISTAL® |
| Optics material | Plastic, PMMA |
| Enclosure rating | IP67 IP69K |
| Items supplied | Fastening nut (1x), M18, plastic, black, flat |
| Electromagnetic compatibility (EMC) | EN 60947-5-2 (The sensor complies with the Radio Safety Requirements (EMC) for the industrial sector (Radio Safety Class A). It may cause radio interference if used in a residential area.) |
| Ambient operating temperature | -40 °C ... +70 °C |
| Ambient temperature, storage | -40 °C ... +75 °C |
| UL File No. | E189383 |

¹⁾ May not fall below or exceed U_y tolerances.

²⁾ Without signal strength light bar and load.

³⁾ Pin 4 and pin 2: This switching output must not be connected to another output.

⁴⁾ Signal transit time with resistive load.

⁵⁾ With light/dark ratio 1:1.

⁶⁾ A = V_S connections reverse-polarity protected.

⁷⁾ B = inputs and output reverse-polarity protected.

⁸⁾ D = outputs overcurrent and short-circuit protected.

Safety-related parameters

| | |
|-------------------------|-------------|
| MTTF_D | 730.1 years |
| DC_{avg} | 0 % |

Connection type/pinouts

| | |
|------------------------|--------------------------|
| Connection type | Male connector M8, 4-pin |
| Pinouts | |
| BN 1 | + (L+) |
| WH 2 | Q ₂ |
| BU 3 | - (M) |
| BK 4 | Q ₁ |

Classifications

| | |
|-----------------------|----------|
| ECLASS 5.0 | 27270902 |
| ECLASS 5.1.4 | 27270902 |
| ECLASS 6.0 | 27270902 |
| ECLASS 6.2 | 27270902 |
| ECLASS 7.0 | 27270902 |
| ECLASS 8.0 | 27270902 |
| ECLASS 8.1 | 27270902 |
| ECLASS 9.0 | 27270902 |
| ECLASS 10.0 | 27270902 |
| ECLASS 11.0 | 27270902 |
| ECLASS 12.0 | 27270902 |
| ETIM 5.0 | EC002717 |
| ETIM 6.0 | EC002717 |
| ETIM 7.0 | EC002717 |
| ETIM 8.0 | EC002717 |
| UNSPSC 16.0901 | 39121528 |

Dimensional drawing (Dimensions in mm (inch))

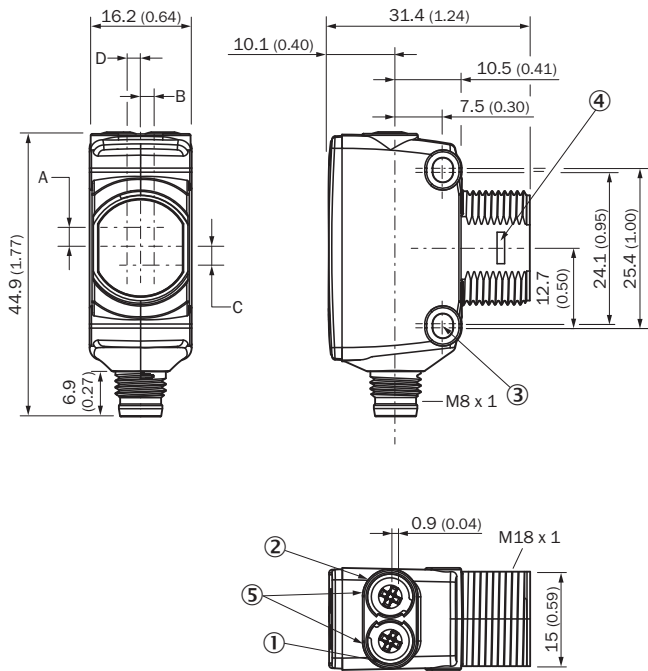

- ① LED indicator yellow: Status of received light beam
- ② LED indicator green: power on
- ③ M3 mounting hole
- ④ Snap Connection for flush ring (sold seperatly)
- ⑤ Potentiometer (if selected) or LED Indicators

| Dimensions in mm (inch) | Receiver | | Sender | |
|-----------------------------------------|--------------|------------|------------|------------|
| | A | B | C | D |
| HTB18 / HTF18 | - 1.1 (0.04) | 1.1 (0.04) | 4.7 (0.19) | 0.6 (0.02) |
| HTE18 / HL18 / HSE18 | 2.5 (0.1) | 0.0 (0.0) | 4.0 (0.16) | 0.0 (0.0) |
| HTB18L / HTF18L / HL18L / HSE18L | 2.5 (0.1) | 0.0 (0.0) | 3.5 (0.14) | 0.0 (0.0) |

Adjustments

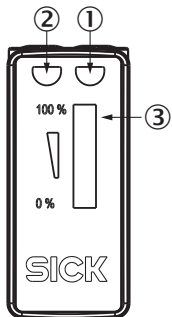

- ① LED indicator yellow: Status of received light beam
- ② LED indicator green: power on
- ③ Signal strength light bar

Connection type

Pinouts, see table Technical data: **Connection type/pinouts**

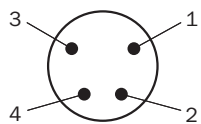

Male connector, M8, 4-pin, uncoded

Characteristic curve

Operating reserve

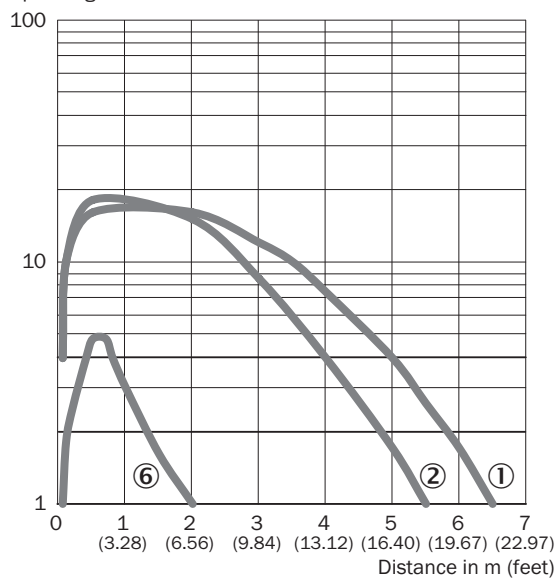

- ① Reflector PL80A
- ② Reflector PL40A
- ⑥ Reflective tape IREF6000 (REF-IRF-56)

Light spot size

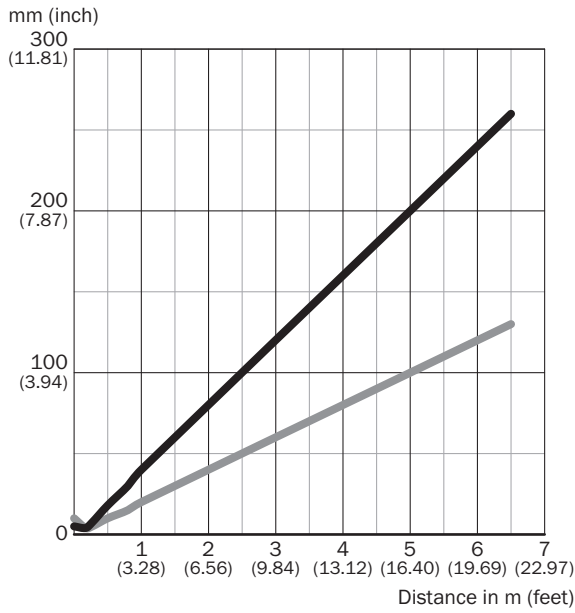

Dimensions in mm (inch)

| Sensing range | Horizontal | Vertical |
|-------------------------------------|----------------|---------------|
| 0.5 m (1.64 feet) | 18 (0.71) | 10 (0.39) |
| 1 m (3.28 feet) | 40 (1.57) | 20 (0.79) |
| 5 m (16.40 feet) | 200 (7.87) | 100 (3.94) |
| 6.5 m (21.33 feet) | 260 (10.24) | 130 (5.12) |

— Horizontal
— Vertical

Sensing range diagram

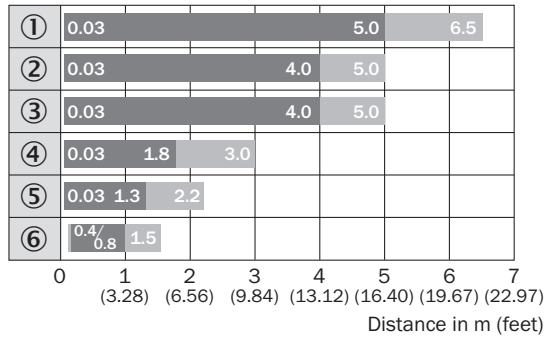

■ Sensing range ■ Sensing range max.





- ① Reflector PL80A
- ② Reflector PL40A
- ③ Reflector P250
- ④ Reflector PL30A, PL31A
- ⑤ Reflector PL20A
- ⑥ Reflective tape IREF6000 (REF-IRF-56)

Functions



Recommended accessories

Other models and accessories → www.sick.com/H18_Sure_Sense

| | Brief description | Type | Part no. |
|-------------------------------------------------------------------------------------|------------------------------------------------------------------------------------------------------------------------------------------------------------------------------------------------------------------------------------------------------------------------------------------------------------------------------------------------------------------------------------------------------------------------------------|--------------------|----------|
| Mounting brackets and plates | | | |
|  | Universal mounting bracket for reflectors, steel, zinc coated | BEF-WN-REFX | 2064574 |
| Reflectors | | | |
|  | Rectangular, screw connection, 51 mm x 61 mm, PMMA/ABS, Screw-on, 2 hole mounting | P250 | 5304812 |
| Others | | | |
|  | <ul style="list-style-type: none"> • Connection type head A: Female connector, M8, 4-pin, straight, A-coded • Connection type head B: Flying leads • Signal type: Sensor/actuator cable • Cable: 5 m, 4-wire, PVC • Description: Sensor/actuator cable, unshielded • Application: Zones with chemicals, Uncontaminated zones | YF8U14-050VA3XLEAX | 2095889 |
|  | <ul style="list-style-type: none"> • Connection type head A: Male connector, M8, 4-pin, straight, A-coded • Description: Unshielded • Connection systems: Screw-type terminals • Permitted cross-section: 0.14 mm² ... 0.5 mm² | STE-0804-G | 6037323 |

SICK AT A GLANCE

SICK is one of the leading manufacturers of intelligent sensors and sensor solutions for industrial applications. A unique range of products and services creates the perfect basis for controlling processes securely and efficiently, protecting individuals from accidents and preventing damage to the environment.

We have extensive experience in a wide range of industries and understand their processes and requirements. With intelligent sensors, we can deliver exactly what our customers need. In application centers in Europe, Asia and North America, system solutions are tested and optimized in accordance with customer specifications. All this makes us a reliable supplier and development partner.

Comprehensive services complete our offering: SICK LifeTime Services provide support throughout the machine life cycle and ensure safety and productivity.

For us, that is “Sensor Intelligence.”

WORLDWIDE PRESENCE:

Contacts and other locations –www.sick.com